

USER MANUAL

FHF05 series

Foil heat flux sensors with thermal spreaders, flexible,
5 different dimensions and sensitivities, with temperature
sensor

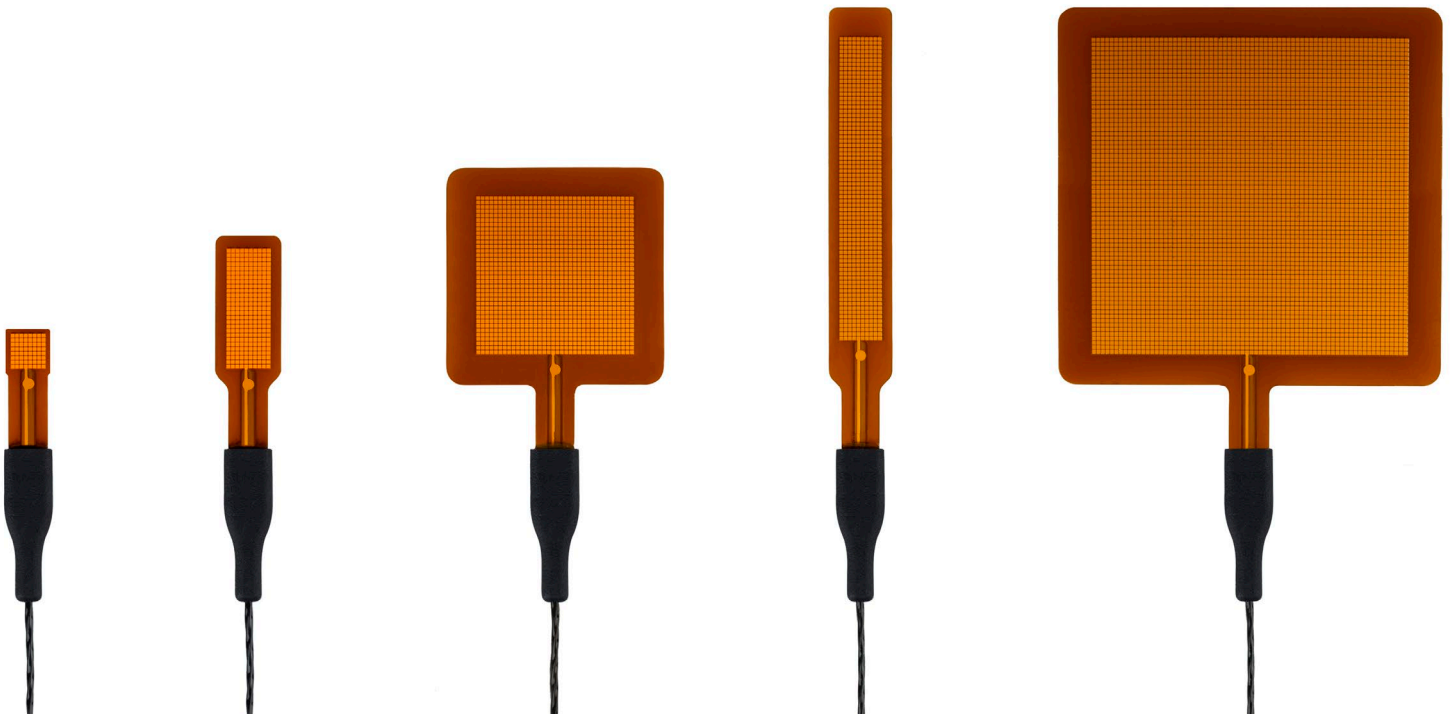

Cautionary statements

Cautionary statements are subdivided into four categories: danger, warning, caution and notice according to the severity of the risk.

 DANGER
Failure to comply with a danger statement will lead to death or serious physical injuries.

 WARNING
Failure to comply with a warning statement may lead to risk of death or serious physical injuries.

 CAUTION
Failure to comply with a caution statement may lead to risk of minor or moderate physical injuries.

NOTICE
Failure to comply with a notice may lead to damage to equipment or may compromise reliable operation of the instrument.

Contents

Cautionary statements	2
Contents	3
List of symbols	4
Introduction	5
1 Ordering and checking at delivery	8
1.1 Ordering FHF05 series	8
1.2 Included items	8
1.3 Quick instrument check	9
2 Instrument principle and theory	10
3 Specifications of FHF05 series	13
3.1 Specifications of FHF05 series	13
3.2 Dimensions of FHF05 series	17
4 Standards and recommended practices for use	19
4.1 Heat flux measurement in industry	19
5 Installation of FHF05 series	20
5.1 Site selection and installation	20
5.2 Installation on curved surfaces	22
5.3 Electrical connection	23
5.4 Requirements for data acquisition / amplification	26
6 Maintenance and trouble shooting	27
6.1 Recommended maintenance and quality assurance	27
6.2 Trouble shooting	28
6.3 Calibration and checks in the field	29
7 Appendices	31
7.1 Appendix on cable and wire extension	31
7.2 Appendix on installation of FHF05 series sensor foil	32
7.3 Appendix on using FHF05 series with BLK – GLD sticker series	35
7.4 Appendix on standards for calibration	36
7.5 Appendix on calibration hierarchy	36
7.6 Appendix on correction for temperature dependence	37
7.7 Appendix on measurement range for different temperatures	38
7.8 Appendix on temperature measurement accuracy	39
7.9 EU declaration of conformity	41

List of symbols

Quantities

Heat flux
Voltage output
Sensitivity
Temperature
Thermal resistance per unit area

Symbol

Φ
U
S
T
 $R_{\text{thermal,A}}$

Unit

W/m²
V
V/(W/m²)
°C
K/(W/m²)

subscripts

property of heatsink
maximum value, specification limit

heatsink
maximum

Introduction

FHF05 series are the latest standard model for general-purpose heat flux measurement. Models are available in five dimensions and sensitivities. Significantly thinner and more flexible, FHF05 series replaces earlier models FHF01 to FHF04. All FHF05 models are very versatile: they have an integrated temperature sensor and thermal spreaders to reduce thermal conductivity dependence. It is applicable over a temperature range from -70 to $+120$ °C. FHF05 series measures heat flux from conduction, radiation and convection. Optionally, black BLK and gold GLD stickers are available for every sensor model to separately determine heat transport by radiation and convection.

All FHF05's measure heat flux through the object in which it is incorporated or on which it is mounted, in W/m^2 . The sensor within is a thermopile. This thermopile measures the temperature difference across FHF05's flexible body. A type T thermocouple is integrated as well. The thermopile and thermocouple are passive sensors; they do not require power.

Multiple small thermal spreaders, which form a conductive layer covering the sensor, help reduce the thermal conductivity dependence of the measurement. With its incorporated spreaders, the sensitivity of FHF05 series is independent of its environment. Many competing sensors do not have thermal spreaders. The passive guard area around the sensor reduces measurement errors due to edge effects and is also used for mounting. Looking for heat flux and temperature measurement with a heater? See our [FHF05SC series](#) heat flux sensors.

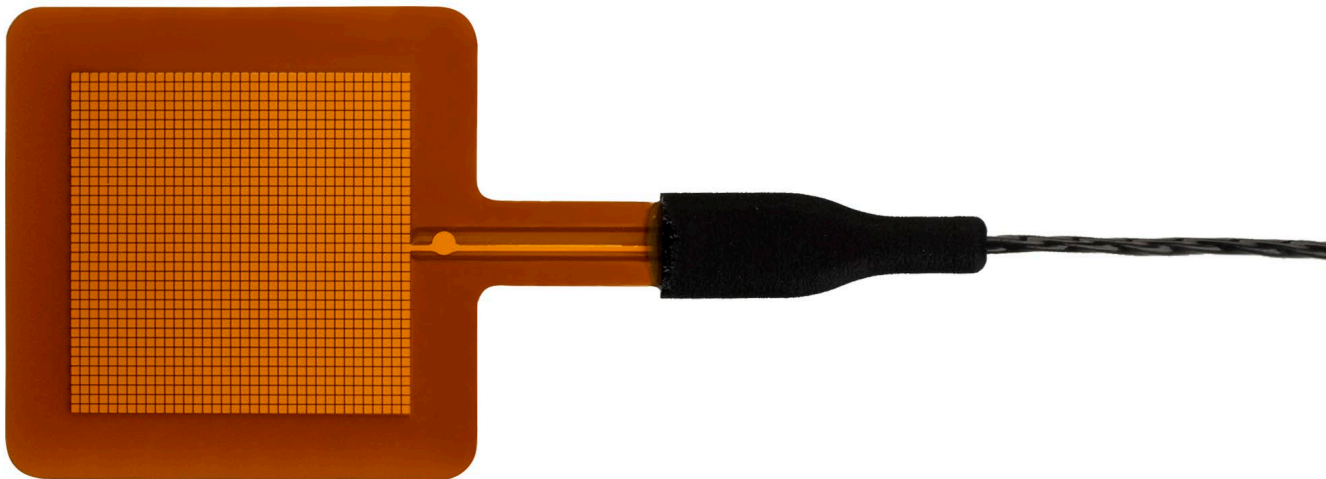

Figure 0.1 Model FHF05-50X50 foil heat flux sensor with thermal spreaders: thin, flexible and versatile.

Using FHF05 series is easy. It can be connected directly to commonly used data logging systems. The heat flux in W/m^2 is calculated by dividing the sensor output, a small voltage, by the sensitivity. The sensitivity is provided with FHF05 series on its product certificate.

All FHF05's have unique features and benefits:

- flexible (bending radius $\geq 7.5 \times 10^{-3}$ m)
- low thermal resistance
- wide temperature range
- fast response time
- large guard area
- integrated thermal spreaders for low thermal conductivity dependence
- integrated type T thermocouple
- robustness, including cable and connection block which may be used as strain relief between sensor and cable
- IP protection class: IP67 (essential for outdoor application)

Equipped with a protective potted connection block, which may serve as strain relief so that moisture does not penetrate, FHF05 series has proven to be very robust and stable.



Figure 0.2 Model FHF05-15X85 foil heat flux sensor being installed to measure heat flux on a pipe.

FHF05 series has calibration that is traceable to international standards. The factory calibration method follows the recommended practice of ASTM C1130 - 21. When used under conditions that differ from the calibration reference conditions, the sensitivity of the FHF05 series to heat flux may be different than stated on its certificate. See Chapter 2 in this manual for best practices.

Would you like to study energy transport / heat flux in detail? Hukseflux helps taking this measurement to the next level: order FHF05 series with radiation-absorbing black BLK and radiation-reflecting gold GLD stickers. You can then measure convective + radiative flux with one, and convective flux only with the other. Subtract the two measurements and you have radiative flux. They can be applied to the sensor by the user or ordered pre-applied at the factory; see the [BLK – GLD sticker series user manual](#) and [installation video](#) for instructions. Stickers are available for every sensor model.

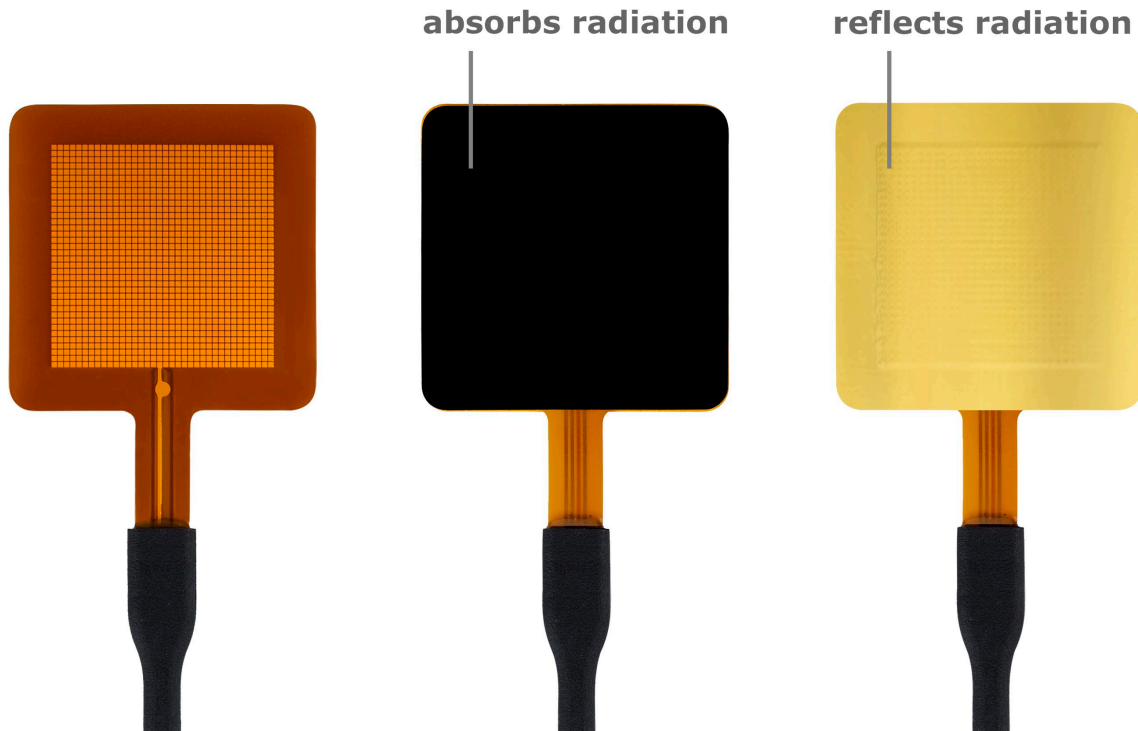

Figure 0.3 Model FHF05-50X50 heat flux sensor: with BLK-50X50 and GLD-50X50 stickers.

See also:

- **FHF05SC series** for a self-calibrating version of FHF05
- **HTR02 series heater**, for calibration and verification of performance of FHF-type sensors
- model **HFP01** for increased sensitivity (also consider putting two or more FHF05's in series)
- **BLK - GLD sticker series** for every sensor dimension to separate radiative and convective heat fluxes
- Hukseflux offers a complete range of **heat flux sensors** with the highest quality for any budget

1 Ordering and checking at delivery

1.1 Ordering FHF05 series

The standard configuration of FHF05 series is FHF05-50X05-02, model 50X50 with 2 metres of cable. Common options are:

- model FHF05-10X10
- model FHF05-15X30
- model FHF05-15X85
- model FHF05-85X85
- change -02 to -05 or -10 metres for the respective cable length
- without wiring, without connection block
- with a separate cable in 2, 5, or 10 metres cable length
- with LI19 hand-held read-out unit / datalogger; NOTE: LI19 measures heat flux only, not temperature
- with HTR02 series, a foil heater of calibration and verification of performance
- BLK black sticker (to measure radiative as well as convective heat flux)
- GLD gold sticker (to measure convective heat flux only)
- BLK - GLD sticker series can also be ordered pre-applied at the factory for every sensor dimension

1.2 Included items

Arriving at the customer, the delivery should include:

- heat flux sensor FHF05 with wires of the length as ordered
- product certificate matching the instrument serial number



Figure 1.2.1 Model FHF05-50X50 with serial number and sensitivity shown at the end of the cable.

1.3 Quick instrument check

A quick test of the instrument can be done by connecting it to a multimeter.

1. Check the sensor serial number and sensitivity on the label at the end of FHF05's cable against the product certificate provided with the sensor.
2. Inspect the instrument for any damage.
3. Check the electrical resistance of the sensor between the red [+] and black [-] wires. Use a multimeter at the 1k Ω range. Measure the sensor resistance first with one polarity, then reverse the polarity. Take the average value. The typical resistance of the wiring is 0.3 Ω /m. Typical resistance should be the nominal sensor resistance mentioned in table 3.1.1 plus 0.6 Ω for the total resistance of two wires for each metre (back and forth). Infinite resistance indicates a broken circuit; zero or a lower than 1 Ω resistance indicates a short circuit.
4. Check the electrical resistance of the thermocouple between the brown [+] and white [-] wires. Use a multimeter at the 100 Ω range. Measure the thermocouple resistance first with one polarity, then reverse the polarity. Take the average value. The typical resistance of the copper wiring is 0.3 Ω /m, for the constantan wiring this is 6.5 Ω /m. Typical resistance should be the nominal thermocouple resistance of 2.5 Ω plus 6.8 Ω for the total resistance of the two wires of each metre (back and forth). Infinite resistance indicates a broken circuit; zero or a lower than 1 Ω resistance indicates a short circuit.
5. Check if the sensor reacts to heat: put the multimeter at its most sensitive range of DC voltage measurement, typically the 100 x 10⁻³ VDC range or lower. Expose the sensor to heat. Exposing the back side (the side without the dot) to heat should generate a positive signal between the red [+] and black [-] wires. Doing the same at the front side (the side with the dot), reverses the sign of the output.

2 Instrument principle and theory

FHF05 series' scientific name is heat flux sensor. A heat flux sensor measures the heat flux density through the sensor itself. This quantity, expressed in W/m^2 , is usually called "heat flux".

FHF05 series users typically assume that the measured heat flux is representative of the undisturbed heat flux at the location of the sensor. Users may also apply corrections based on scientific judgement.

The sensor in FHF05 series is a thermopile. This thermopile measures the temperature difference across the polyimide body of the sensor. Working completely passive, the thermopile generates a small voltage that is a linear function of this temperature difference. The heat flux is proportional to the same temperature difference divided by the effective thermal conductivity of the heat flux sensor body.

Using FHF05 series is easy. For readout the user only needs an accurate voltmeter that works in the millivolt range. To convert the measured voltage, U , to a heat flux Φ , the voltage must be divided by the sensitivity S , a constant that is supplied with each individual sensor.

$$\Phi = U/S \quad \text{(Formula 2.1.1)}$$

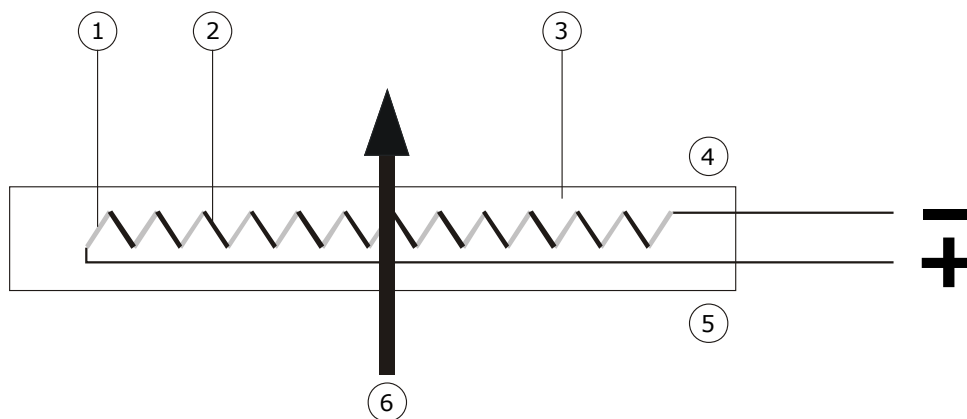

Figure 2.1 The general working principle of a heat flux sensor. The sensor inside FHF05 series is a thermopile. A thermopile consists of a number of thermocouples, each consisting of two metal alloys (marked 1 and 2), electrically connected in series. A single thermocouple generates an output voltage that is proportional to the temperature difference between its hot- and cold joints. Putting thermocouples in series amplifies the signal. In a heat flux sensor, the hot- and cold joints are located at the opposite sensor surfaces (4 and 5). In steady state, the heat flux (6) is a linear function of the temperature difference across the sensor and the average thermal conductivity of the sensor body (3). The thermopile generates a voltage output proportional to the heat flux through the sensor. The exact sensitivity of the sensor is determined at the manufacturer by calibration, and can be found on the product certificate that is supplied with each sensor.



Figure 2.2 Heat flux from the back side to the front side generates a positive voltage output signal. The dot on the foil indicates the front side.

All FHF05's are designed such that heat flux from the back side to the front side generates a positive voltage output signal. The dot on the foil indicates the front side.

Unique features of the FHF05 series include flexibility (bending radius $\geq 7.5 \times 10^{-3}$ m), low thermal resistance, a wide temperature range, a fast response time, IP67 protection class rating (essential for outdoor application), and the inclusion of thermal spreaders to reduce thermal conductivity dependence.

All FHF05's are calibrated under the following reference conditions:

- conductive heat flux (as opposed to radiative or convective heat flux)
- homogeneous heat flux across the sensor and guard surface
- room temperature
- heat flux in the order of 300 or 600 W/m² generated with our HTR02 series
- mounted on aluminium heat sink

FHF05 series has been calibrated using a well-conducting metal heat sink, representing a typical industrial application, at 20 °C and exposing it to a conductive heat flux. When used under conditions that differ from the calibration reference conditions, for example at extremely high or low temperatures, or exposed to radiative flux, the FHF05 series sensitivity to heat flux may be different than stated on the certificate. In such cases, the user may choose:

- not to use the sensitivity and only perform relative measurements / monitor changes
- reproduce the calibration conditions by mounting the sensor on, or between metal foils
- design a dedicated calibration experiment, for example using a foil heater which generates a known heat flux
- correct the sensitivity for the temperature dependence. See appendix 7.6 for more information
- apply our BLK black sticker to the sensor surface to absorb radiation
- apply our GLD gold sticker to the sensor surface to reflect radiation

The user should analyse his own experiment and make his own uncertainty evaluation. The FHF05 series rated temperature range for continuous use is -70 to +120 °C, for short intervals, peak temperatures -160 to +150 °C are allowed. Please contact Hukseflux when measuring at -160 °C. Prolonged exposure to temperatures near +150 °C will accelerate the ageing process.

3 Specifications of FHF05 series

3.1 Specifications of FHF05 series

FHF05 series measures the heat flux density through the surface of the sensor. This quantity, expressed in W/m^2 , is called heat flux. Working completely passive, using a thermopile sensor, FHF05 series generates a small output voltage proportional to this flux. It can only be used in combination with a suitable measurement system.

Table 3.1.1 Specifications of FHF05 series (continued next pages).

FHF05 SERIES SPECIFICATIONS	
Sensor type	foil heat flux sensor
Sensor type according to ASTM	heat flow sensor or heat flux transducer
Measurand	heat flux
Measurand in SI units	heat flux density in W/m^2
Measurement range	$(-10 \text{ to } +10) \times 10^3 \text{ W/m}^2$ at heat sink temperature $20 \text{ }^\circ\text{C}$ see appendix for detailed calculations
Sensitivity per dimension (nominal)	
FHF05-10X10	$1 \times 10^{-6} \text{ V}/(\text{W/m}^2)$
FHF05-15X30	$3 \times 10^{-6} \text{ V}/(\text{W/m}^2)$
FHF05-50X50	$13 \times 10^{-6} \text{ V}/(\text{W/m}^2)$
FHF05-15X85	$7 \times 10^{-6} \text{ V}/(\text{W/m}^2)$
FHF05-85X85	$50 \times 10^{-6} \text{ V}/(\text{W/m}^2)$
Directional sensitivity	heat flux from the back side to the front side (side with the dot) generates a positive voltage output signal
Asymmetry	$< 2 \%$
Increased sensitivity	multiple sensors may be put electrically in series. The resulting sensitivity is the sum of the sensitivities of the individual sensors
Expected voltage output	$(-100 \text{ to } +100) \times 10^{-3} \text{ V}$ turning the sensor over from one side to the other will lead to a reversal of the sensor voltage output
Measurement function / required programming	$\Phi = U/S$
Required readout	1 differential voltage channel or 1 single ended voltage channel, input resistance $> 10^6 \Omega$
Optional readout	1 temperature channel
Rated load on wires	$\leq 1.6 \text{ kg}$
Rated bending radius	$\geq 7.5 \times 10^{-3} \text{ m}$
Rated temperature range, continuous use	$-70 \text{ to } +120 \text{ }^\circ\text{C}$
Rated temperature range, short intervals	$-160 \text{ to } +150 \text{ }^\circ\text{C}$ (contact Hukseflux when measuring at $-160 \text{ }^\circ\text{C}$)
Temperature dependence	$< 0.2 \%/^\circ\text{C}$
Non-linearity	$< 5 \%$ ($0 \text{ to } 10 \times 10^3 \text{ W/m}^2$)
Solar absorption coefficient	0.75 (indication only)
Thermal conductivity dependence	negligible, $< 3 \%/(\text{W/m}\cdot\text{k})$ from $270 \text{ to } 0.3 \text{ W/m}\cdot\text{K}$
Sensor length and width	
FHF05-10X10	$(10 \times 10) \times 10^{-3} \text{ m}$
FHF05-15X30	$(15 \times 30) \times 10^{-3} \text{ m}$
FHF05-50X50	$(50 \times 50) \times 10^{-3} \text{ m}$
FHF05-15X85	$(15 \times 85) \times 10^{-3} \text{ m}$
FHF05-85X85	$(85 \times 85) \times 10^{-3} \text{ m}$

Table 3.1.1 Specifications of FHF05 series (started on previous pages).

Sensing area	
FHF05-10X10	$0.64 \times 10^{-4} \text{ m}^2$
FHF05-15X30	$2.70 \times 10^{-4} \text{ m}^2$
FHF05-50X50	$12.96 \times 10^{-4} \text{ m}^2$
FHF05-15X85	$7.10 \times 10^{-4} \text{ m}^2$
FHF05-85X85	$47.70 \times 10^{-4} \text{ m}^2$
Sensing area length and width	
FHF05-10X10	$(8 \times 8) \times 10^{-3} \text{ m}$
FHF05-15X30	$(10 \times 27) \times 10^{-3} \text{ m}$
FHF05-50X50	$(36 \times 36) \times 10^{-3} \text{ m}$
FHF05-15X85	$(10 \times 71) \times 10^{-3} \text{ m}$
FHF05-85X85	$(70 \times 71) \times 10^{-3} \text{ m}$
Passive guard area	
FHF05-10X10	$0.36 \times 10^{-4} \text{ m}^2$
FHF05-15X30	$2.25 \times 10^{-4} \text{ m}^2$
FHF05-50X50	$12.04 \times 10^{-4} \text{ m}^2$
FHF05-15X85	$5.65 \times 10^{-4} \text{ m}^2$
FHF05-85X85	$22.55 \times 10^{-4} \text{ m}^2$
Guard width to thickness ratio	
FHF05-10X10	2.5
FHF05-15X30	6.25
FHF05-50X50	17.5
FHF05-15X85	6.25
FHF05-85X85	18.75
Sensor thickness	$0.4 \times 10^{-3} \text{ m}$
Sensor thermal resistance	$11 \times 10^{-4} \text{ K}/(\text{W}/\text{m}^2)$
Sensor thermal conductivity	$0.36 \text{ W}/(\text{m}\cdot\text{K})$
Response time (95 %)	3 s
Sensor resistance range per dimension	
FHF05-10X10	5 – 30 Ω
FHF05-15X30	50 – 90 Ω
FHF05-50X50	200 – 300 Ω
FHF05-15X85	100 – 180 Ω
FHF05-85X85	800 – 1300 Ω
Required sensor power	zero (passive sensor)
Temperature sensor	type T thermocouple
Temperature sensor accuracy	$\pm 5 \%$ (of temperature in $^{\circ}\text{C}$), see appendix 7.8 for directions how to reduce the uncertainty to $\pm 2 \%$ which is the normal specification for Class 2 thermocouples
Standard wire length	2 m
Optional wire length	0, 5 or 10 m
Wiring	3 x copper and 1 x constantan wire, AWG 28, solid core, bundled with a MFA sheath
Cable diameter	$2 \times 10^{-3} \text{ m}$
Marking	dot on foil indicating front side of the heat flux sensor; 1 x label at end of FHF05's cable, showing serial number and sensitivity
IP protection class	IP67
Rated operating relative humidity range	0 to 100 %
Use under water	FHF05 is not suitable for continuous use under water
Gross weight including 2 m wires	approx. 0.5 kg
Net weight including 2 m wires	approx. 0.5 kg

Table 3.1.1 Specifications of FHF05 series (started on previous pages).

INSTALLATION AND USE	
Typical conditions of use	in experiments, in measurements in laboratory and industrial environments. Exposed to heat fluxes for periods of several minutes to several years. Connected to user-supplied data acquisition equipment. Regular inspection of the sensor. Continuous monitoring of sensor temperature. No special requirements for immunity, emission, chemical resistance.
Recommended number of sensors	2 per measurement location
Installation	see Chapter 5 on installation for recommendations
Bending	see Section 5.2 on installation on curved surfaces
Cable extension	see Appendix 7.1 on cable extension, or order sensors with longer cable length
Sensor foil installation	see Appendix 7.2 on installation of FHF05 without wiring, without connection block
CALIBRATION	
Calibration traceability	to SI units
Product certificate	included (showing calibration result and traceability)
Calibration method	method HFPC, according to ASTM C1130 - 21
Calibration hierarchy	from SI through international standards and through an internal mathematical procedure
Calibration uncertainty	$< \pm 5\%$ ($k = 2$)
Recommended recalibration interval	2 years
Calibration reference conditions	20 °C, heat flux of 300 (models -15X85 and -85X85) or 600 (models -10X10, -15X30 and 50X50) W/m ² , mounted on aluminium heat sink, thermal conductivity of the surrounding environment 0.0 W/(m·K)
Validity of calibration	based on experience the instrument sensitivity will not change during storage. During use the instrument "non-stability" specification is applicable. When used under conditions that differ from the calibration reference conditions, the FHF05 sensitivity to heat flux may be different than stated on its certificate. See the chapter on instrument principle for suggested solutions
Field calibration	is possible by comparison to a calibration reference sensor. Usually mounted side by side, alternative on top of the field sensor. Preferably reference and field sensor of the same model and brand. Typical duration of test > 24 h
MEASUREMENT ACCURACY	
Uncertainty of the measurement	statements about the overall measurement uncertainty can only be made on an individual basis.
VERSIONS / OPTIONS	
With longer cable length	option code = cable length in metres
Without cable, without connection block	calibrated FHF05 sensor foil to be soldered / connected by the user see appendix for more information
With black sticker applied	BLK sticker applied to the sensor at the factory to absorb radiation
With gold sticker applied	GLD sticker applied to the sensor at the factory to reflect radiation
ACCESSORIES	
Hand-held read-out unit	LI19 handheld read-out unit / datalogger NOTE: LI19 does not measure temperature, only heat flux

Separate foil heater	HTR02 general-purpose heater, that can be used for test and calibration purposes
Separate cable	cable with 3 x copper and 1 x constantan wire, AWG 28, solid core, bundled with an MFA sheath available in 2, 5 or 10 m length
Separate black stickers	BLK sticker to absorb radiation, to be applied by the user
Separate gold sticker	GLD sticker to reflect radiation, to be applied by the user

3.2 Dimensions of FHF05 series

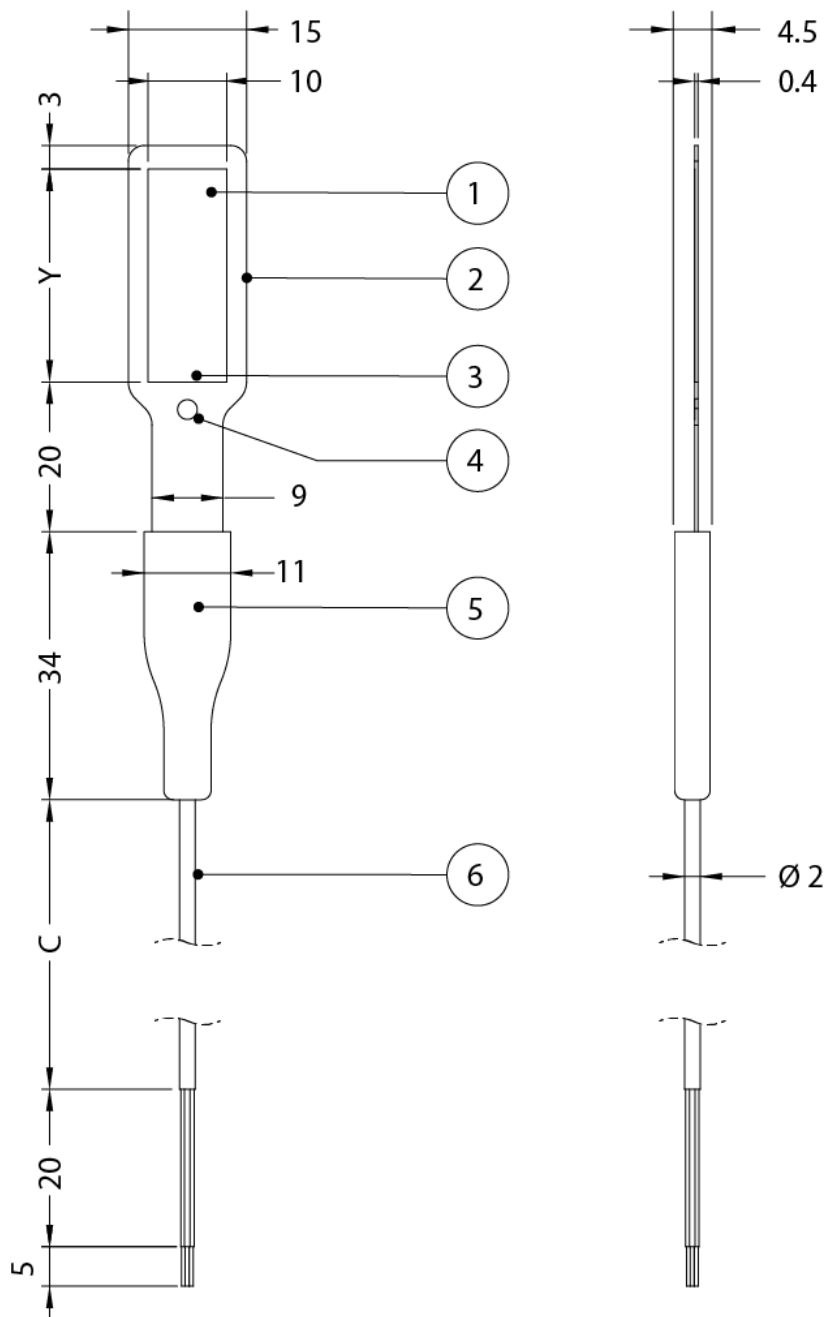

Figure 3.2.1 Models FHF05 15X30 and 15X85; $Y_1 = 27$ or 70 , $Y_2 = 18$ or 25 with dimensions in $\times 10^{-3}$ m

- (1) sensing area with thermal spreaders
- (2) passive guard
- (3) type T thermocouple
- (4) dot indicating front side
- (5) connection block for strain relief
- (6) cable, standard length $C = 2$ m

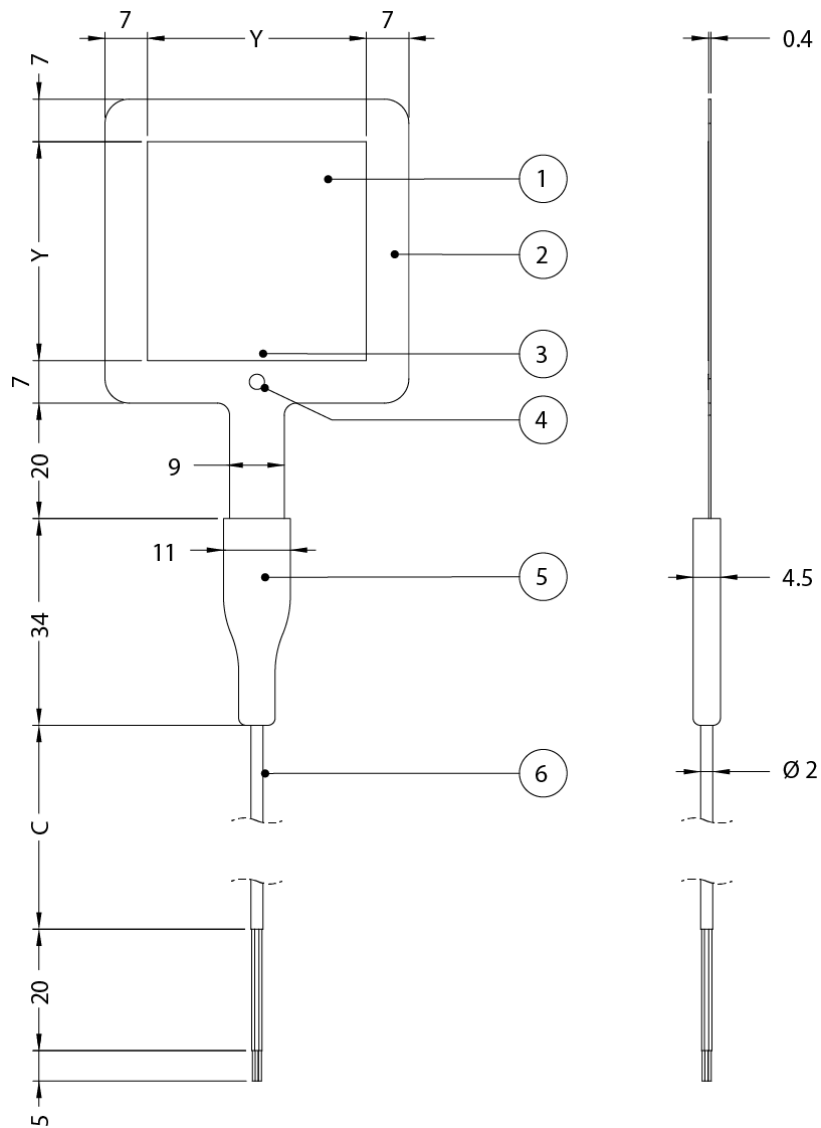

Figure 3.2.2 Models FHF05 10X10, 50X50 and 85X85 heat flux sensor; $Y = 8, 36$ or 70 , dimensions in $\times 10^{-3}$ m

- (1) sensing area with thermal spreaders
- (2) passive guard
- (3) type T thermocouple
- (4) dot indicating front side
- (5) connection block for strain relief
- (6) cable, standard length $C = 2$ m

4 Standards and recommended practices for use

FHF05 series should be used in accordance with recommended practices.

4.1 Heat flux measurement in industry

FHF05 series sensors are often used to measure on industrial walls and metal surfaces, estimating the installation's energy balance and the thermal transmission of walls. Typically, the total measuring system consists of multiple heat flux- and temperature sensors. In many cases heat flux sensors are used for trend monitoring. In such cases reproducibility is more important than absolute measurement accuracy.



Figure 4.1.1 Example of model FHF05-85X85 foil heat flux sensor being installed for measurement on an industrial pipe. The sensor is mounted on a well-prepared curved surface.

5 Installation of FHF05 series

5.1 Site selection and installation

Table 5.1.1 Recommendations for installation of FHF05 series heat flux sensors.

Location	<p>choose a location that is representative of the process that is analysed if possible, avoid exposure to sun, rain, etc. do not expose to drafts and lateral heat fluxes do not mount in the vicinity of thermal bridges, cracks, heating or cooling devices and fans</p>
Performing a representative measurement / recommended number of sensors	<p>we recommend using > 2 sensors per measurement location. This redundancy also improves the assessment of the measurement accuracy</p>
Mounting	<p>when mounting a FHF05, keep the directional sensitivity in mind heat flux from the back side to the front side (side with dot) generates a positive voltage output signal to achieve the highest accuracy temperature measurement, fix the connection block to the object of interest, so that the temperature of the connection block remains as close as possible to that of the heat flux sensor (see appendix)</p>
Surface cleaning and levelling	<p>create a clean and smooth surface of at least the outer dimensions of the sensor in use</p>
Mechanical mounting: avoiding strain on the sensor to cable transition	<p>during installation as well as operation, the user should provide proper strain relief on the cable so that the connection block is not exposed to significant force first install the sensor by providing strain relief on the connection block and after that install the cable including additional strain relief</p>
Short-term installation	<p>avoid any air gaps between sensor and surface. Air thermal conductivity is in the 0.02 W/(m·K) range, while a common glue has a thermal conductivity around 0.2 W/(m·K). A 0.1×10^{-3} m air gap increases the effective thermal resistance of the sensor by 200 % to avoid air gaps, we recommend thermal paste or glycerol for short term installation use tape to fixate the sensor on the surface. If possible, tape only over the passive guard area (surrounding the sensing area). See Figure 3.2.1 use tape to fixate the connection block of the sensor usually, the cables are fixated with an additional strain relief, for example using a cable tie mount as in Figure 5.1.1</p>
Permanent installation	<p>for long-term installation fill up the space between sensor and object with silicone construction sealant, silicone glue or silicone adhesive, that can be bought at construction depots. We discourage the use of thermal paste for permanent installation because it tends to dry out. Silicone glue is more stable and reliable</p>
Signal amplification	<p>see the paragraph on electrical connection</p>

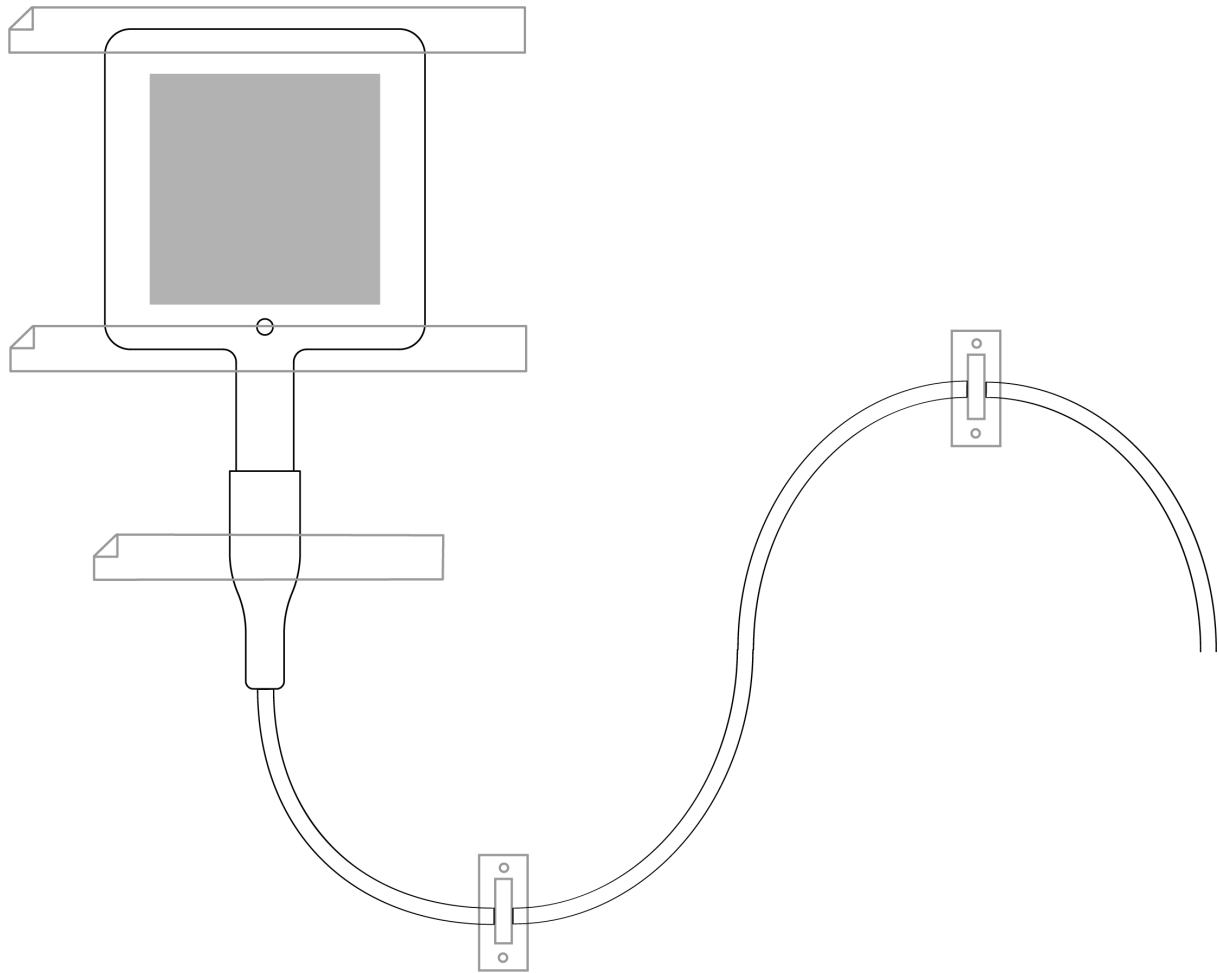

Figure 5.1.1 *Installation of model FHF05-50X50 using tape to fixate the sensor and the connection block. Extra strain relief on the cable is provided using cable tie mounts equipped with double sided tape as adhesive. As indicated in Table 5.1.1, tapes fixating the sensor are preferably taped over the passive guard area and not on the sensing area (the latter indicated by grey shading in Figure 5.1.1). Please note the dot is visible in this image; this indicates that we are viewing the front side and that the other side, the back side, is attached on the object on which the sensor is mounted, as explained in Chapter 2.*

See also our application note on [how to install a heat flux sensor](#).

5.2 Installation on curved surfaces

The flexibility of the FHF05 series makes it perfectly suitable to be installed on singly curved surfaces. The sensor can be bent around any axis.



Figure 5.2.1 *Bending of model FHF05-50X50 foil heat flux sensor, in this image on a pipe.*

When measuring on curved surfaces, the same recommendations of the previous chapter apply, except that the use of thermal paste is recommended over glycerol. For installation on curved surfaces, it is usually not achievable to tape only over the passive guard area. Use sufficient tape to make sure the sensor remains fixed and in good thermal contact with curved surface. Avoid air gaps. Tape can be used over the sensing area when necessary.

Table 5.2.1 *Extra recommendations for installation of FHF05 series foil heat flux sensors on curved surfaces.*

Bending	sensor can be bent in both directions
Rated bending radius	$\geq 7.5 \times 10^{-3}$ m
Effect on sensitivity	no significant influence on sensitivity

5.3 Electrical connection

5.3.1 Normal connection

A heat flux sensor should be connected to a measurement system, typically a so-called datalogger. All FHF05 models are passive sensors that do not need any power. Wires may act as a source of distortion, by picking up capacitive noise. We recommend keeping the distance between a datalogger or amplifier and the sensor as short as possible and to keep the signal wires close to each other. For wire extension, see the appendix on this subject.

Table 5.3.1.1 *The electrical connection of FHF05 series.*

WIRE	MEASUREMENT SYSTEM	
Red	heat flux signal [+]	voltage input [+]
Black	heat flux signal [-]	voltage input [-]
Brown	thermocouple type T [+]	thermocouple input [+]
White	thermocouple type T [-]	thermocouple input [-]

The sensor serial number and sensitivity are shown on the FHF05 series product certificate and on the end of FHF05's cable.

NOTICE

**Putting more than 24 Volt across the sensor wiring
can lead to permanent damage to the sensor.**

5.3.2 Increasing sensitivity, connecting multiple sensors in series

Multiple sensors may be electrically connected in series. The resulting sensitivity is the sum of the sensitivity of the individual sensors. Below the equations in case two sensors are used. If needed, more than two sensors may be put in series, again increasing the sensitivity.

$$\Phi = U/(S_1 + S_2) \quad (\text{Formula 5.3.2.1})$$

and

$$U = U_1 + U_2 \quad (\text{Formula 5.3.2.2})$$

Table 5.3.2.1 *The electrical connection of two FHF05 series models, 1 and 2, in series. In such case the sensitivity is the sum of the two sensitivities of the individual sensors. More sensors may be added in a similar manner.*

SENSOR	WIRE	MEASUREMENT SYSTEM	
1	Red	signal 1 [+]	voltage input [+]
1	Black	signal 1 [-]	connected to signal 2 [+]
1	Brown	thermocouple type T [+]	
1	White	thermocouple type T [-]	
2	Red	signal 2 [+]	connected to signal 1 [-]
2	Black	signal 2 [-]	voltage input [-] or ground
2	Brown	thermocouple type T [+]	
2	White	thermocouple type T [-]	

The serial number and sensitivity of the individual sensors are shown on the FHF05 series product certificate and at the end of FHF05's cable.

5.3.3 Connection to read out half signals

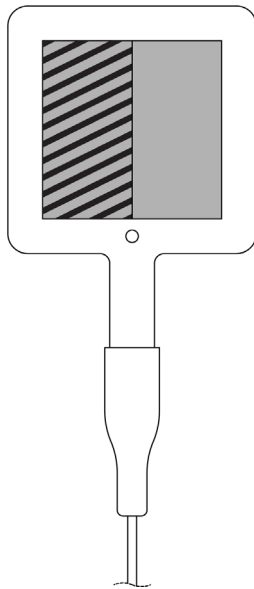

See the figure on the left: FHF05 series can be connected to read out only the heat flux through the left half of the sensing area or the heat flux through the right half of the sensing area. This feature may be used for quality assurance purposes; if the sensor is correctly installed, a constant percentage of the signal will be generated by the left – and right.

Figure 5.3.3.1 model FHF05-50X50 with left half indicated by diagonal lines.

Table 5.3.3.1 The electrical connection of FHF05 series for 100 % signal.

WIRE	MEASUREMENT SYSTEM	
Red	heat flux signal [+]	voltage input [+]
Black	heat flux signal [-]	voltage input [-] or ground
Brown	thermocouple type T [+]	
White	thermocouple type T [-]	

Table 5.3.3.2 The electrical connection of FHF05 series for left 50 % signal.

WIRE	MEASUREMENT SYSTEM	
Red	heat flux signal [+]	voltage input [+]
Black	heat flux signal [-]	
Brown	thermocouple type T [+]	voltage input [-] or ground
White	thermocouple type T [-]	

Table 5.3.3.3 The electrical connection of FHF05 series for right 50 % signal.

WIRE	MEASUREMENT SYSTEM	
Red	heat flux signal [+]	
Black	heat flux signal [-]	voltage input [-] or ground
Brown	thermocouple type T [+]	voltage input [+]
White	thermocouple type T [-]	

5.4 Requirements for data acquisition / amplification

The selection and programming of dataloggers is the responsibility of the user. Please contact the supplier of the data acquisition and amplification equipment to see if directions for use with the FHF05 series are available. In case a program for similar instruments is available, this can be used. All FHF05's can be treated in the same way as other heat flux sensors and (analogue) thermopile pyranometers.

NOTICE

Do not use "open circuit detection" when measuring the sensor output.

Table 5.4.1 *Requirements for data acquisition and amplification equipment for FHF05 series in the standard configuration.*

Capability to measure small voltage signals	preferably: $< 5 \times 10^{-6}$ V uncertainty minimum requirement: 20×10^{-6} V uncertainty (valid for the entire expected temperature range of the acquisition / amplification equipment)
Capability for the data logger or the software	to store data, and to perform division by the sensitivity to calculate the heat flux. $\Phi = U/S$
Capability to measure thermocouple type T	preferably: $< \pm 3$ °C uncertainty
Data acquisition input resistance	$> 1 \times 10^6 \Omega$
Open circuit detection (WARNING)	open-circuit detection should not be used, unless this is done separately from the normal measurement by more than 5 times the sensor response time and with a small current only. Thermopile sensors are sensitive to the current that is used during open circuit detection. The current will generate heat, which is measured and will appear as a temporary offset.

6 Maintenance and trouble shooting

6.1 Recommended maintenance and quality assurance

FHF05 series measures reliably at a low level of maintenance. Unreliable measurement results are detected by scientific judgement, for example by looking for unreasonably large or small measured values. The preferred way to obtain a reliable measurement is a regular critical review of the measured data, preferably checking against other measurements.

Table 6.1.1 Recommended maintenance of FHF05 series. If possible, the data analysis is done daily

MINIMUM RECOMMENDED HEAT FLUX SENSOR MAINTENANCE			
	INTERVAL	SUBJECT	ACTION
1	1 week	data analysis	compare measured data to the maximum possible or maximum expected heat flux and to other measurements for example from redundant instruments. look for any patterns and events that deviate from what is normal or expected. compare to acceptance intervals.
2	6 months	inspection	inspect sensor for wear, cable and wire quality, inspect mounting, inspect location of installation
3	2 years	recalibration	recalibration by comparison to a calibration standard instrument in the field, see Paragraph 6.3. recalibration by the sensor manufacturer
4	2 years	lifetime assessment	judge if the instrument will be reliable for another 2 years, or if it should be replaced

6.2 Trouble shooting

Table 6.2.1 *Trouble shooting for FHF05 series.*

General	<p>Inspect the sensor for any damage. Inspect the quality of mounting / installation. Inspect if the wires are properly attached to the data logger.</p> <p>Check the condition of the cable and wires.</p> <p>Check the datalogger program, in particular if the right sensitivity is entered. FHF05 series sensitivity and serial number are shown on the product certificate and at the end of FHF05's cable.</p> <p>Check the electrical resistance of the sensor between the black [-] and red [+] wires. See specifications table 3.1.1 for the nominal sensitivities per dimension. Measure the sensor resistance first with one polarity, then reverse the polarity. Take the average value. The typical resistance of the wiring is 0.3 Ω/m. Typical resistance should be the nominal sensor resistances stated in table 3.1.1 plus 0.6 Ω for the total resistance of two wires (back and forth) of each m. Infinite resistance indicates a broken circuit; zero or a lower than 1 Ω resistance indicates a short circuit.</p>
The sensor does not give any signal	<p>Check if the sensor reacts to heat: put the multimeter at its most sensitive range of DC voltage measurement, typically the 100 x 10⁻³ VDC range or lower. Expose the sensor to heat. Exposing the back side (the side without the dot) to heat should generate a positive signal between the red [+] and black [-] wires, doing the same at the front side (the side with dot), the sign of the output reverses. Check the data acquisition by replacing the sensor with a spare unit.</p>
The sensor signal is unrealistically high or low	<p>Check the wire condition.</p> <p>Check the data acquisition by applying a 1 x 10⁻⁶ V source to it in the 1 x 10⁻⁶ V range. Look at the measurement result. Check if it is as expected.</p> <p>Check the data acquisition by short circuiting the data acquisition input with a 10 Ω resistor. Look at the output. Check if the output is close to 0 W/m².</p>
The sensor signal shows unexpected variations	<p>Check the presence of strong sources of electromagnetic radiation (radar, radio).</p> <p>Check the condition of the sensor wires.</p> <p>Check if the wires are not moving during the measurement.</p>
The temperature measurement shows unrealistic values	<p>Check if the thermocouple type T is selected in the datalogger program.</p> <p>Check if a correct reference temperature is selected in the program.</p> <p>Check the electrical resistance of the thermocouple between the brown [+] and white [-] wires. Use a multimeter at the 100 Ω range. Measure the thermocouple resistance first with one polarity, then reverse the polarity. Take the average value. The typical resistance of the copper wiring is 0.3 Ω/m, for the constantan wiring this is 6.5 Ω/m. Typical resistance should be the nominal thermocouple resistance of 2.5 Ω plus 6.8 Ω for the total resistance of the two wires of each metre (back and forth). Infinite resistance indicates a broken circuit; zero or a lower than 1 Ω resistance indicates a short circuit.</p> <p>Make sure the temperature of the connection block remains as close as possible to that of the heat flux sensor. See appendix on temperature measurement accuracy for more information.</p>

6.3 Calibration and checks in the field

The recommended calibration interval of heat flux sensors is 2 years.
Recalibration of field heat flux sensors is ideally done by the sensor manufacturer.

On-site field calibration is possible by comparison to a calibration reference sensor.
Usually mounted side by side, alternatively mounted on top of the field sensor.

Hukseflux main recommendations for field calibrations are:

- 1) to compare to a calibration reference of the same brand and type as the field sensor
- 2) to connect both to the same electronics, so that electronics errors (also offsets) are eliminated
- 3) to mount all sensors on the same platform, so that they have the same body temperature
- 4) typical duration of test: > 24 h
- 5) typical heat fluxes used for comparison: > 200 W/m²
- 6) to correct deviations of more than ± 20 %. Lower deviations should be interpreted as acceptable and should not lead to a revised sensitivity

Users may also design their own calibration experiment, for example using a well characterised foil heater.

7 Appendices

7.1 Appendix on cable and wire extension

FHF05 series is equipped with one cable containing four wires. Standard cable length is 2 m. It is possible to order FHF05 series with longer cable lengths or without any cable. A separate cable is available in 2, 5 or 10 m length.

Wires may act as a source of distortion by picking up capacitive noise. Keep the distance between data logger or amplifier and sensor as short as possible.

In an electrically “quiet” environment the FHF05 series cable may be extended without problem. If done properly, the sensor signal, although small, will not significantly degrade because the sensor resistance is very low (which results in good immunity to external sources) and because there is no current flowing (so no resistive losses).

Wire and connection specifications are summarised below.

Table 7.1.1 Preferred specifications for wire extension of FHF05 series.

Wire	3 x copper and 1 x constantan wire, AWG 28, solid core, bundled with an PFA sheath
Separate cable	Available in 2, 5 or 10 m length
Extension sealing	make sure any connections are sealed against humidity ingress
Conductor resistance	< 0.3 Ω /m (copper wire)
Outer cable diameter	2 x 10 ⁻³ m
Length	cable should be kept as short as possible, in any case the total cable length should be less than 100 m
Connection	either use gold plated waterproof connectors, or solder the new wire conductors and shield to those of the original sensor wire, and make a waterproof connection using heat-shrink tubing with hot-melt adhesive when using connectors, use dedicated type T thermocouple connectors for extending the thermocouple wires

7.2 Appendix on installation of FHF05 series sensor foil

FHF05 series can optionally be ordered without cable and without connection block. It is possible to order a separate cable. The user should ensure a good connection to the sensor by either soldering wires or alternatively, using a FFC / FPC ZIF connector. See Table 7.2.1 and 7.2.2 for recommendations.

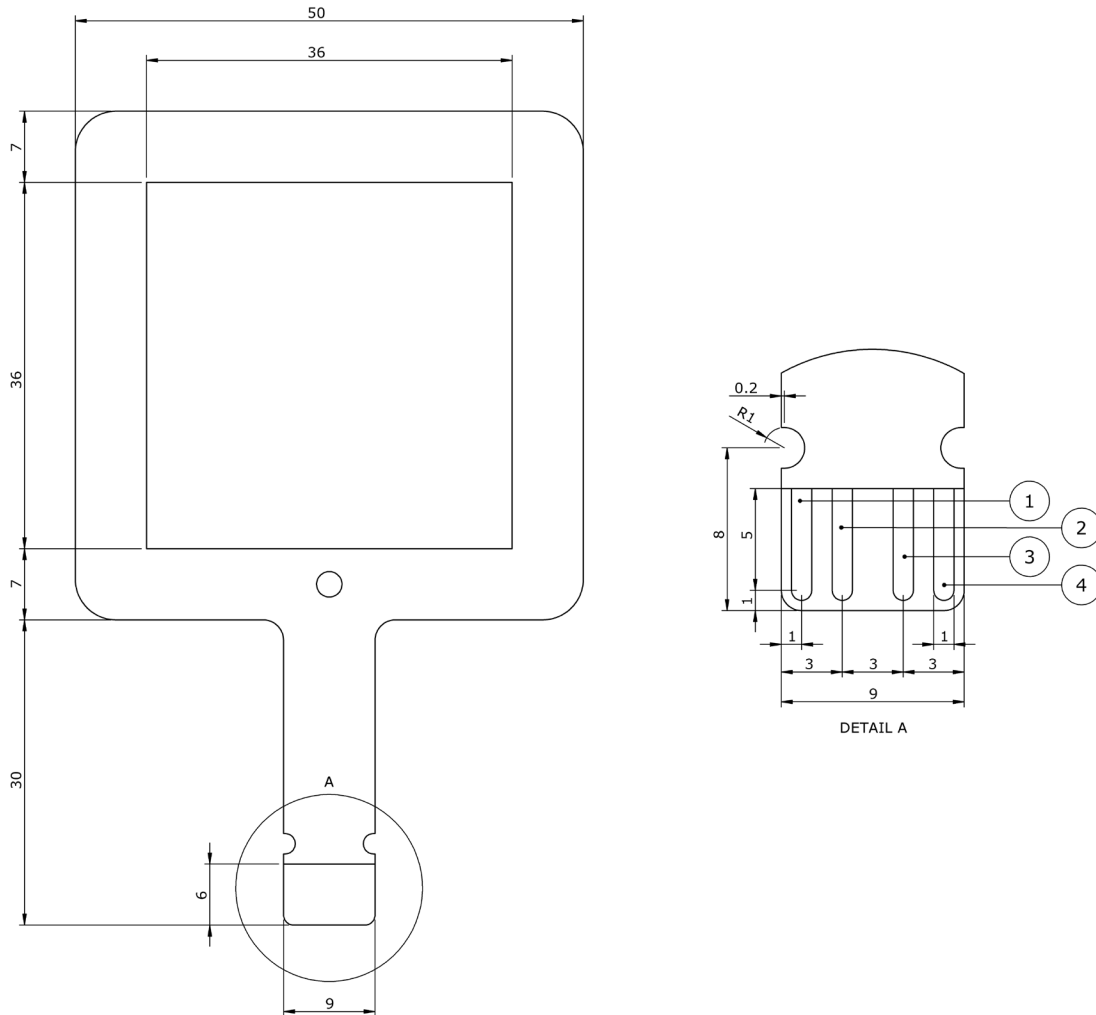

Figure 7.2.1 FHF05-50X50 sensor foil; detail A is the same for all FHF05's; dimensions in $\times 10^{-3}$ m.

- (1) heat flux signal [+], copper
- (2) thermocouple type T [+], copper
- (3) thermocouple type T [-], constantan ($\text{Cu}_{55}\text{Ni}_{45}$)
- (4) heat flux signal [-], copper

Table 7.2.1 Recommendations for soldering FHF05 series sensor foils.

Wire	use insulated wires of preferably at least AWG28 it is possible to order a separate cable see Figure 7.2.1 for which material to use on which contact
Preparation	clean soldering pad before soldering with isopropyl alcohol (IPA)
Solder material	preferably use lead free solder
Soldering temperature	use a soldering temperature of max 350 °C
Contact time	as short as possible (± 2 seconds)
Surface	place sensor with soldering pad on a well-insulated surface
Strain relief	add additional strain relief on the solder connections, for example by potting the connection with epoxy

NOTICE

Cross-connecting the wires while soldering will short circuit the sensor.

NOTICE

Avoid long contact while soldering as excess heat can damage the soldering contacts.

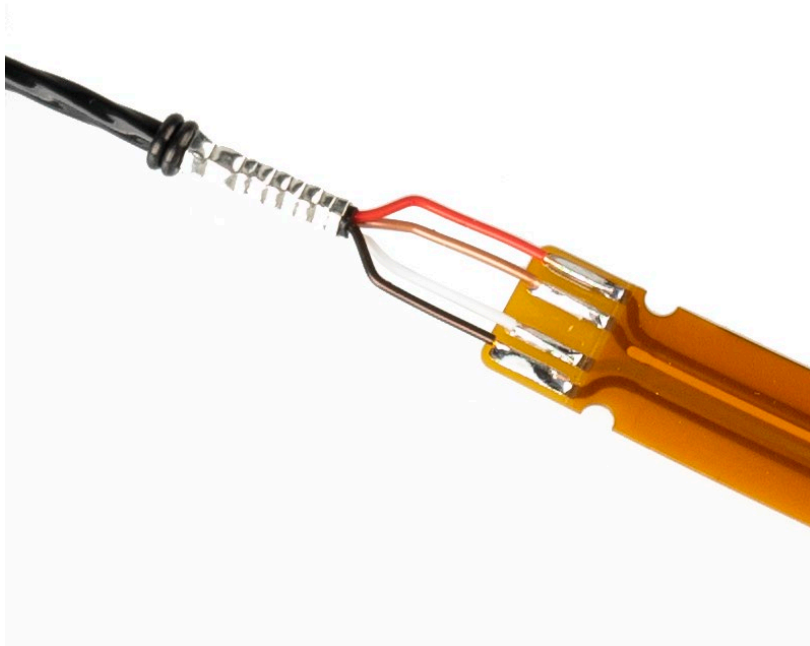

Figure 7.2.2 FHF05 series sensor foil with soldered wires.

Table 7.2.2 Recommendations for connectors for FHF05 series sensor foils.

Connector type	FFC / FPC (Flat Flex Cable / Flexible Printed Circuit)
Connector variant	ZIF (Zero Insertion Force)
Number of contacts	8 contacts, where only position 1, 3, 6 and 8 are used
Pitch	$1 \times 10^{-3} \text{ m}$
External environment	use FHF05 sensor foils with connector in a dry and stable environment

7.3 Appendix on using FHF05 series with BLK – GLD sticker series

BLK black and GLD gold stickers are accessories to the FHF05 series and FHF05SC series heat flux sensors. A sensor equipped with a BLK black sticker is sensitive to both radiative and convective heat flux. A sensor equipped with a GLD gold sticker reflects radiation and measures convective heat flux only. To calculate the radiative heat flux, subtract the two measurements.

There are BLK – GLD stickers for every sensor in FHF05 series.

BLK - GLD stickers are designed to be applied by the user. Optionally, it is also possible to order FHF05 with stickers pre-applied at the factory.

For more details, see the BLK – GLD sticker series user manual.

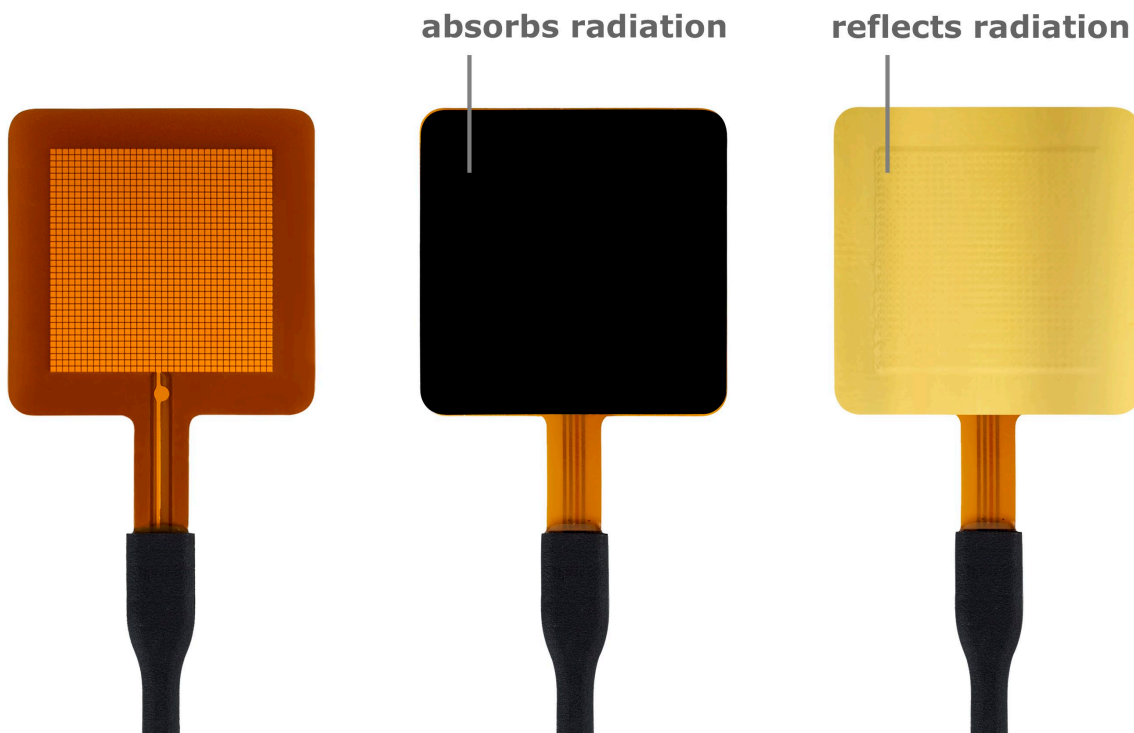

Figure 7.3.1 FHF05-50X50 heat flux sensor: with BLK-50X50 and GLD-50X50 stickers.

Table 7.3.1 Recommendations for use of FHF05 series heat flux sensors with BLK – GLD stickers.

Mounting	when mounting an FHF05 with a BLK or GLD sticker, keep the directional sensitivity in mind heat flux from the back side to the front side (side with dot) generates a positive voltage output signal.
Mounting on curved surfaces	apply BLK – GLD stickers before mounting the sensor
Location	avoid direct exposure to the sun
Effect on sensitivity	BLK-GLD stickers have no significant influence on sensitivity

7.4 Appendix on standards for calibration

The standard ASTM C1130 - 21 Standard Practice for Calibrating Thin Heat Flux Transducers specifies in chapter 6 that a guarded hot plate, a heat flowmeter, a hot box or a thin heater apparatus are all allowed. Hukseflux employs a thin heater apparatus, uses a linear function according to X1.1 and uses a nominal temperature of 20 °C, in accordance with X2.2.

The Hukseflux HFPC method relies on a thin heater apparatus according to principles as described in paragraph 4 of ASTM C1114 - 06, used in the single sided mode of operation described in paragraph 8.2 and in ASTM C1044 - 16.

ISO does not have a dedicated standard practice for heat flux sensor calibration. We follow the recommended practice of ASTM C1130 - 21.

Table 7.4.1 Heat flux sensor calibration according to ISO and ASTM.

STANDARDS ON INSTRUMENT CLASSIFICATION AND CALIBRATION	
ISO STANDARD	EQUIVALENT ASTM STANDARD
no dedicated heat flux calibration standard available.	ASTM C1130 - 21 Standard Practice for Calibrating Thin Heat Flux Transducers ASTM C 1114 - 06 Standard Test Method for Steady-State Thermal Transmission Properties by Means of the Thin-Heater Apparatus ASTM C1044 - 16 Standard Practice for Using a Guarded-Hot-Plate Apparatus or Thin-Heater Apparatus in the Single-Sided Mode

7.5 Appendix on calibration hierarchy

FHF05 series factory calibration is traceable from SI through international standards and through an internal mathematical procedure that corrects for known errors. The formal

traceability of the generated heat flux is through voltage and current to electrical power and electric power and through length to surface area.

The Hukseflux HFPC method follows the recommended practice of ASTM C1130 - 21. It relies on a thin heater apparatus according to principles as described in Paragraph 4 of ASTM C1114 - 06, in the single sided mode of operation described in Paragraph 8.2 and in ASTM C1044 - 16. The method has been validated in a first-party conformity assessment, by comparison to calibrations in a guarded hot plate.

7.6 Appendix on correction for temperature dependence

The sensitivity of a FHF05 series depends on the temperature of the sensor. The temperature dependence of FHF05 series is specified as < 0.2 %/°C.

The calibration reference temperature is 20 °C.

Users that measure at temperatures that deviate much from 20 °C, or users that measure over a wide range of temperatures, may wish to correct for this temperature dependence.

To correct for the temperature dependence of the sensitivity, use the measurement function

$$\Phi = U / (S \cdot (1 + 0.002 \cdot (T - 20))) \quad (\text{Formula 7.6.1})$$

with Φ the heat flux in W/m², U the FHF05 series voltage output in V, S the sensitivity in V/(W/m²) at 20 °C and T the FHF05 temperature.

S is shown on the product certificate and at the end of FHF05's cable .

7.7 Appendix on measurement range for different temperatures

The measurement range of FHF05 series is specified as $(-10 \text{ to } +10) \times 10^3 \text{ W/m}^2$ at $20 \text{ }^\circ\text{C}$ heat sink temperature. This is a very conservative specification.

In reality, the rated temperature for continuous use of $+120 \text{ }^\circ\text{C}$ is the limiting specification. The sensor temperature T in $^\circ\text{C}$ in a specific application depends on the heatsink temperature T_{heatsink} in $^\circ\text{C}$, the heat flux Φ in W/m^2 and the thermal resistance per unit area $R_{\text{thermal,A}}$ of the sensor in $\text{K}/(\text{W/m}^2)$.

$$T = T_{\text{heatsink}} + \Phi \cdot R_{\text{thermal,A}} \quad (\text{Formula 7.7.1})$$

This means the measurement range is lower for higher heat sink temperatures.

$$\Phi_{\text{maximum}} = (120 - T_{\text{heatsink}}) / R_{\text{thermal,A}} \quad (\text{Formula 7.7.2})$$

Table 7.5.1 shows measurement ranges for different heat sink temperatures. For applications where the sensor is not mounted on a heatsink, use the ambient temperature instead of heatsink temperature.

Table 7.7.1 Measurement range for different heat sink temperatures.

HEATSINK TEMPERATURE (In $^\circ\text{C}$)	MEASUREMENT RANGE
20 $^\circ\text{C}$	$84 \times 10^3 \text{ W/m}^2$
40 $^\circ\text{C}$	$67 \times 10^3 \text{ W/m}^2$
60 $^\circ\text{C}$	$51 \times 10^3 \text{ W/m}^2$
80 $^\circ\text{C}$	$34 \times 10^3 \text{ W/m}^2$
100 $^\circ\text{C}$	$17 \times 10^3 \text{ W/m}^2$

7.8 Appendix on temperature measurement accuracy

All FHF05's have an integrated thermocouple to measure temperature of the object under test. This thermocouple is supplied as a secondary measurement, in addition to the main heat flux measurement.

Expanded uncertainty

The total measurement uncertainty is the sum of the thermocouple measurement uncertainty + the cold junction uncertainty. The cold junction uncertainty can be found in the specifications of electronics. Typically this is ± 1 °C.

Thermocouple measurement uncertainty

The FHF05 series has a cable with thermocouple extension wires specified as a type T thermocouple, IEC 60584-1:2013 class 2. They consist of a brown positive copper (Cu) wire and a negative white constantan ($\text{Cu}_{55}\text{Ni}_{45}$) wire. Accuracy is ± 2 % for temperature differences between T_2 and T_3 (see figure 7.8.1).

In the FHF05 sensor itself, the thermocouple junction (T_1) consists of copper and constantan traces that are extended from the connection block to the edge of the heat flux sensor sensitive area. These traces have slightly different Seebeck coefficients compared to the wires, which results in a higher measurement uncertainty of ± 5 % for temperature differences between T_1 and T_2 junctions.

Take home: make sure $T_1 = T_2$. If that is the case then:

$$u_c(T_1) = \text{cold junction} + 2\% (\Delta T_1 + \Delta T_2)$$

The total expanded uncertainty in T_1 ($U_c(T_1)$ in °C, coverage factor of 2) based on the of uncertainty in the measurement of the temperature differences between T_1 and T_2 , ΔT_1 , and between T_2 and T_3 or ΔT_2 and the error in their Seebeck coefficients.

If $T_1 \neq T_2$ the combined standard uncertainty can be calculated by the law of propagation of uncertainty:

$$u_c(T_1) = 5\% \cdot \Delta T_1 + 2\% \cdot \Delta T_2 \quad (\text{Formula 7.8.1})$$

For simplicity, the worst-case scenario of ± 5 % accuracy of the absolute temperature measurement in °C is given as specification for the measurement uncertainty.

It is clear from formula 7.8.1 that the accuracy is best, i.e., in the 2 % range, T_1 is kept close to the temperature T_2 . If the temperature measurement is critical, consider using a separate temperature sensor.

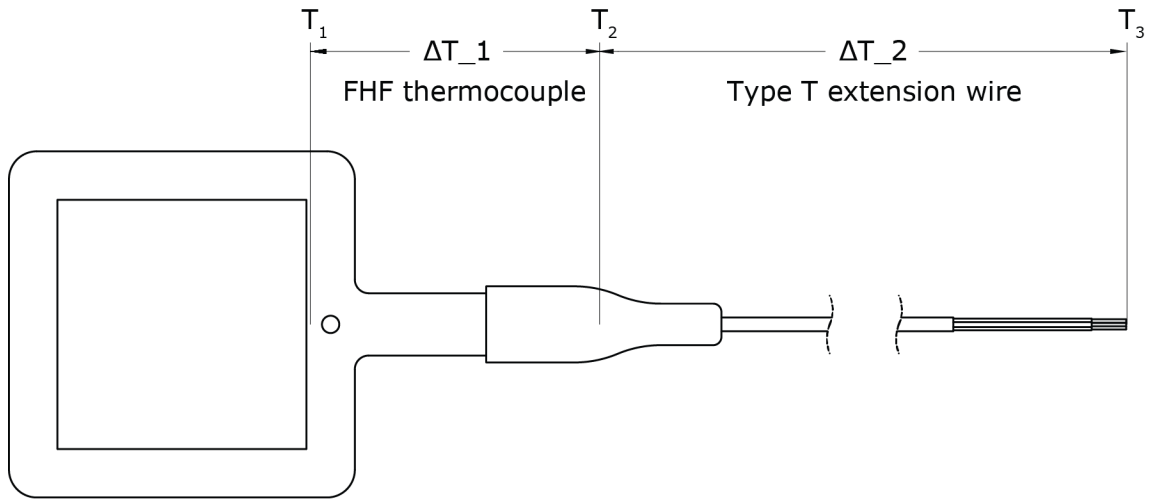

Figure 7.8.1 Model FHF05-50X50 with its thermocouple junctions. To minimise uncertainty, please make sure that ΔT_1 is close to zero.

7.9 EU declaration of conformity



We, Hukseflux Thermal Sensors B.V., Delftechpark 31, Delft,
The Netherlands

hereby declare under our sole responsibility that:

Product model FHF05 series, all models
Product type Heat flux sensors

conform with the following directive(s):

2011/65/EU, EU 2015/863 The Restriction of Hazardous Substances Directive

This conformity is declared using the relevant sections and requirements of the following standards:

Hazardous substances RoHS 2 and EU 215/863 amendment known as RoHS 3

A handwritten signature in blue ink, appearing to be 'Eric Hoeksema', written in a cursive style.

Eric HOEKSEMA
Director
Delft, 09 November, 2022