

User Manual SHM 31

Snow depth sensor

· a passion for precision · passion pour la précision · pasión por la precisión · passione per la precisione · a

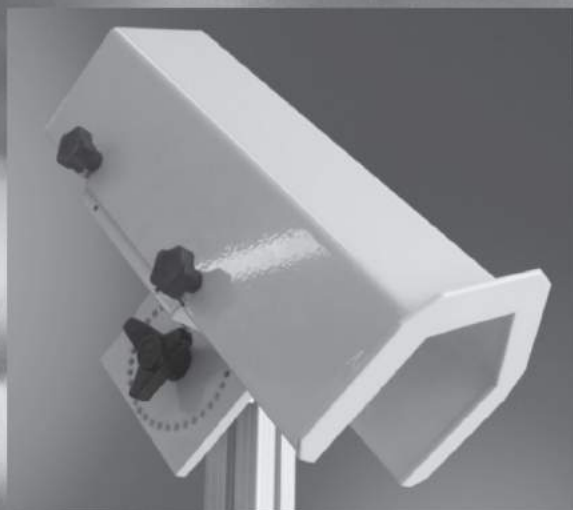

www.lufft.de

 **Lufft**



Dear User

You are advised to read this manual carefully before you start using the SHM 31 snow depth sensor. This is necessary to ensure that you will be able to use all the features, which have been integrated in the device.

This technology is subject to further development.

Company address

G. Lufft Mess- und Regeltechnik GmbH
(in short: G. Lufft GmbH)

Gutenbergstrasse 20

70736 Fellbach

Germany

Phone: +49 711 51822-0

Hotline: +49 711 51822-52

Fax: +49 711 51822-41

Email: info@lufft.com (sales, repair)

Email: service@lufft.com (technical support)

Sensor and manual was first published in April 2017

Date	Revision	Change log
11/18	Rev 1.9	Update SDI12 chapter for SDI12 v1.4, several updates
03/18	Rev 1.8	Add Modbus chapter
03/18	Rev 1.7	Chapter 7 revised, various small changes
11/17	Rev 1.6	Links fixed, section 9.3 added, 11.1 small changes
08/17	Rev 1.5	Figures updated, fixes in all chapters
07/17	Rev 1.4	Fixes in all chapters
04/17	Rev 1.0	First published



Note:

This manual is protected by copyright. No part of the manual may be reproduced in any way (by photographing, photocopying, microfilm or any other technique) without the prior written approval of G. Lufft, nor may it be processed, duplicated or disseminated with the help of electronic systems. Any offence against these rules will be prosecuted. Proper care was used in compiling this document. No liability will be accepted in the event of damage resulting from failure to comply with information provided herein.

Contents

1	Read before commissioning!	6
1.1	Safety Labeling	6
1.2	General safety notes	6
1.3	Safety notes regarding laser system	6
1.4	Intended use	7
1.5	Incorrect use	7
1.6	Warranty	7
1.7	Used brands	7
2	Order numbers and technical data	8
2.1	Labelling	8
2.2	Technical data	9
2.3	Scope of delivery	10
2.4	Additional documents and software	12
3	Device description	13
3.1	Principles of the measurement technique	13
3.2	Introduction to mounting and start-up	13
4	Generation of the measurement results	15
4.1	Measurement values (cur, avg)	15
4.2	Standard operation	15
5	Installation	16
5.1	Installation instructions	16
5.2	Assembly	16
6	Connections	19
6.1	Device connection	19
6.2	Connector pin assignment	19
6.3	Supply voltage	20
6.4	Data interfaces	20
6.5	Heating release function	20
7	Start-up procedure	21
7.1	Important instructions during commissioning	21
7.2	Switching the device on	21
7.2.1	Configuration using RS232 or RS485	21
7.3	UMB-ConfigTool.NET	21
7.3.1	Basic installation using the ConfigTool.NET with serial interface	22
7.3.2	Adjusting SHM 31 sensor parameters	29
8	Communication via UMB-ASCII 2.0	32
8.1	Syntax	32
8.2	Checksum	32
8.3	Examples	32
8.4	Description of the data telegram #1 with an example	33
8.5	Angle adjustment	34
8.6	Switching from UMB protocol to ASCII protocol	34
8.7	ASCII command overview	34
9	UMB Communication	41
9.1	UMB Factory settings	41
9.2	Overview measuring channels	41
9.3	Communication in RS485 binary protocol	44

9.3.1	Framing.....	44
9.3.2	Addressing with Class and Device ID.....	44
9.3.3	Examples for Creating Addresses.....	45
9.3.4	Example of a Binary Protocol Request.....	45
9.3.5	Status and Error Codes in Binary Protocol.....	46
9.3.6	CRC Calculation.....	46
10	Communication in SDI-12 Mode.....	47
10.1	Pin assignment for SDI-12.....	47
10.2	Preconditions for SDI-12 Operation.....	47
10.3	Exit SDI-12 mode.....	47
10.4	Command Set.....	49
10.5	Address Configuration.....	50
10.6	Data messages.....	50
10.6.1	Example: C and M-requests from SHM31-UMB.....	51
10.6.2	Buffer Assignment Basic Data Set SHM31-UMB.....	51
10.7	Additional Measurement Commands.....	52
10.8	Message Device Identification.....	53
10.9	Message Verification.....	53
10.10	Message Request Measurement Value Parameters (SDI-12 v1.4).....	55
10.11	Switching commands.....	55
10.11.1	Command Change of Unit System.....	56
10.11.2	Command Device Reset.....	56
10.11.3	Command Terminate Measurement.....	56
10.11.4	Command Start Measurement.....	56
10.11.5	Command Laser On.....	57
10.11.6	Command Laser Off.....	57
10.11.7	Command Calibrate Offset and Angle.....	57
10.11.8	Command Calibrate Offset.....	57
10.11.9	Command Switch on defrost mode.....	57
10.11.10	Command Switch off heater defrost mode.....	58
10.12	Parameter commands.....	58
10.12.1	Request of the Current Parameter Setting.....	58
10.12.2	Setting of Parameters.....	59
11	Communication in Modbus Mode.....	60
11.1	Modbus Connection and Communication Parameters.....	60
11.2	Addressing.....	60
11.3	Modbus Functions.....	60
11.3.1	Functions 0x03 Read Holding Registers, 0x06 Write Single Register, 0x16 Write Multiple Registers.....	61
11.3.2	Function 0x04 Read Input Registers.....	62
12	Check the signal quality.....	66
12.1	Application.....	66
13	Service, maintenance and technical support.....	68
13.1	Firmware update.....	68
13.2	Maintenance.....	69
Cleaning of the front screen.....	69	
13.3	Malfunction.....	70
13.3.1	Possible error indications at the snow depth sensor:.....	70
13.3.2	Possible disturbing influences, which can affect the proper functioning.....	70

13.3.3 Error codes.....	70
13.4 UMB status codes.....	71
13.5 Within the EU.....	71
13.6 Outside the EU.....	72
13.7 Service / Repair.....	72
13.8 Technical Support.....	72

1 Read before commissioning!

Before using the equipment, please read this user and operating manual carefully and follow the instructions in every detail. Keep it for future reference in a place that is easy to reach.

Please note that components of the device and the described software may look slightly different from the illustrations in this manual.

1.1 Safety Labeling



Caution: Warns of potential damage of the equipment and danger for the user



Note: Important general note



Danger Laser hazard: Warns of laser radiation

1.2 General safety notes



- Installation and commissioning must only be carried out by suitable qualified specialist personnel.
- Never take measurements on or touch live electrical parts.
- Pay attention to the technical data, storage and operating conditions.

1.3 Safety notes regarding laser system



SHM 31 is a laser class 2 product in accordance with IEC 60825-1: Third Edition 2014-03. Class 2 lasers are only during short time exposure to the beam (<0.25s) safe for the eyes. Prolonged exposure to the laser beam can damage the eyes. Avoid staring into the beam or pointing it towards persons or animals. When radiation strikes your eye, deliberately close your eyes and turn your head away from the beam. Especially in low light conditions class 2 lasers can lead to temporary blinding and distraction. These indirect consequences can be hazardous for any kind of activity that requires unimpaired eye sight.

Maximum peak radiant output power	0,95 mW
Wavelength	635 nm
Pulse duration	>400 ps
Pulse repetition frequency	320 Mhz
Beam divergence	0,16 mrad x 0,6 mrad

**Caution**

Do not stare into the direct or reflected laser beam or direct it towards persons or animals! When not in use the laser should be stored in a location where unauthorized personnel cannot gain access (no toy).

1.4 Intended use

- The equipment must only be operated within the range of the specified technical data.
- The equipment must only be used under the conditions and for the purposes for which it was designed.
- The safety and operation of the equipment can no longer be guaranteed if it is modified or adapted.



The following basic use is considered as intended:

- Measuring distances to targets within a range of 15 m.
- Determination of snow depth through the measurement of the distance to the snow surface.
- Mounting the sensor pointed toward the ground on a mast or pole under an angle of inclination (see also notes on laser safety).
- Regular cleaning and maintenance.

1.5 Incorrect use

If the device is installed incorrectly:



- It may not function.
- It may be permanently damaged.
- It may fall down and hurt someone.

If the device is not connected correctly:



- It may not function.
- It may be permanently damaged.
- You may risk an electric shock.

1.6 Warranty

The standard warranty period is 12 months from the delivery date, unless otherwise stated. The warranty is forfeited if the designated use is violated.

1.7 Used brands

All brand names used in this manual are subject to the valid trademark right and ownership of the respective owner without restriction.

2 Order numbers and technical data

Article	Order number
SHM31 Snow depth sensor	8365.30
Mounting clamp stainless steel band for mast up to Ø80 mm	8365.608-11
Mounting clamp stainless steel band up to Ø300 mm	8365.609-11
Flexible mast clamp (standard) up to Ø72 mm	8365.610-11
Connection cable 15 m	8365.KAB015
Reference target plate set	8365.KWK-SET
Software UMB ConfigTool.NET	
Replacement sensor module	

Table 1: Order numbers

2.1 Labelling

The SHM31 is provided with the following labels:

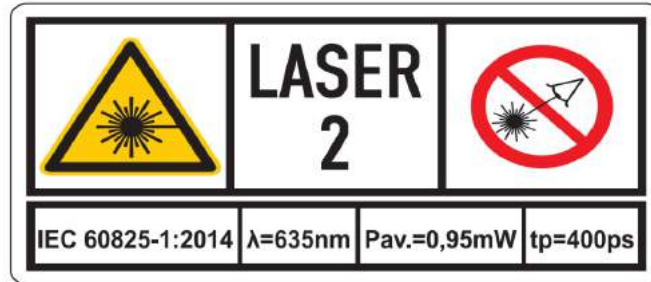

Figure 1: Laser safety label

G. LUFFT Mess- und Regeltechnik GmbH
8365.30 **SHM31 UMB**
 Snow Depth Sensor **UMB**
 CE

Made in Germany



Figure 2: Label with type designation

2.2 Technical data

Category	Description	Value
Measurands	Snow depth	0 ... 15 m
	Accuracy	± (5 mm + 0.06 %)
	Repeatability / reproducibility	0,6 mm / 5 mm
	Resolution	0.1 mm
	Signal strength (normalized)	0 - 255
Installations	Mounting height/ distance	0,1 ... 16 m
	Tilt angle to the ground	10 ... 30 degree
Data interface	RS485	- UMB-Binary-Protocol (19200 Bd default) - UMB-ASCII2.0 - Modbus-RTU - Modbus-ASCII
	SDI-12	- SDI-12 Protocol
	RS232	- UMB-ASCII2.0 Protocol (9600 Bd fixed)
	RS485 and SDI-12 are using the same connector. Therefore they can't be used parallel. RS232 is using separate connectors and can be used parallel with either RS485 or SDI-12.	
	Data transfer	Polling:UMB, UMB-ASCII2.0, SDI-12, Auto-transmit: UMB-ASCII2.0
Operating conditions	Temperature range	-40 °C ... +50 °C
	Rel. humidity	0 ... 100 %
	Voltage supply	12, 24 VDC
	Max. power consumption	18 W
	Ø power consumption without heater	0,7 W
	Ø consumption with 10s measuring interval and window heater on	3,4 W
	MTBF @ 25 °C / 40 °C	88.000 h / 50.000 h
	cable length while using the RS232 interface ¹	≤15 m
Safety	Laser safety	Laser class 2 (IEC 60825-1:2014)
	Protection class	IP68
	EMC	EN 61326-1:2012 (industrial standard)
	EC	2014/30/EU & ROHS 2011/65/EU
Size, weight	Size of sensor (LxWxH)	302 x 130 x 234 mm
	Weight of sensor	2.35 kg
	Size of packaging	400 x 240 x 180 mm
	Weight of packaging	3,4 kg
Storage conditions	Temperature; rel. humidity	T={-25 °C ... +70°C}; rH <100 %

Table 2: Technical data

¹ If longer cable lengths as 15m are used, RS232 communication problems can occur and in addition the voltage drop depending on the cable length has to be taken into account.

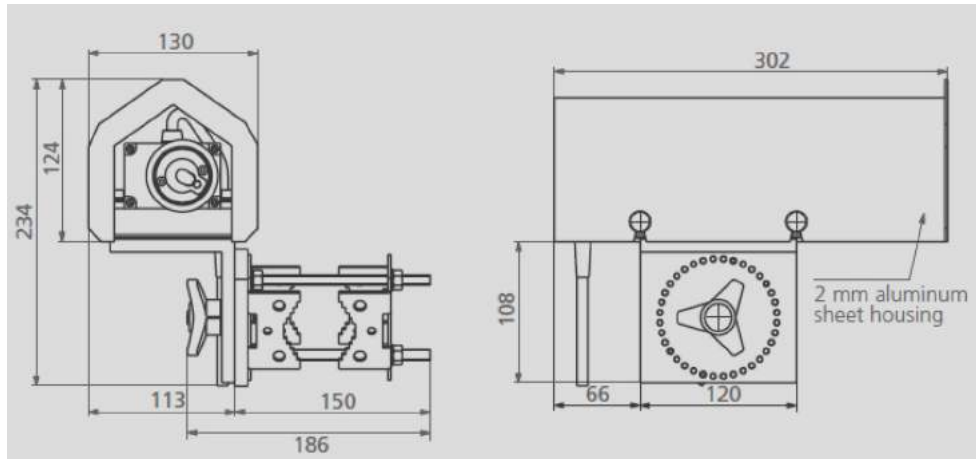

Figure 3: SHM31 metrics, CAD

2.3 Scope of delivery

The delivery consists of the standard delivery scope (see 4) and additional components (see Figures 5 to 9).



Figure 4: Standard delivery scope 8365.30, consists of SHM 31 sensor, test reports and quick start guide and an USB stick with additional software, manual and documents

- SHM31
8365.30
- Mounting clamp
8365.610-11
- Connection cable
8365.KAB015



Figure 5: SHM31 sensor, with mounting clamp 8365.610-11 and connection cable

- Mounting clamp (flexible)
8365.610-11



Figure 6: Mounting clamp 8365.610-11

- Mounting clamp with
stainless steel band
8365.608-11
- or
- 8365.609-11

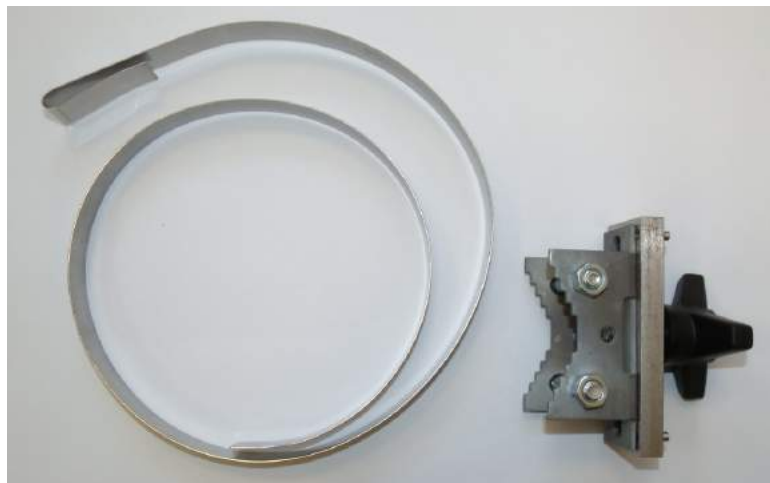

Figure 7: Mounting clamp with stainless steel band for mast diameter up to $\varnothing = 300 \text{ mm}$ ($l = 1000 \text{ mm}$)

Connection cable
8365.KAB015



Figure 8: Connection cable SHM31 for power and data, standard length is 15 m

Reference target plate
(photo card) set
8365.KWK-SET



Figure 9: target plate set consists of a white and black calibrated plate for reference measurements in field and lab

- Documentation
 - Quick start guide
 - Test report
 - Configuration overview (state of delivery)
- USB Stick Manual and the software UMB ConfigTool.NET

2.4 Additional documents and software

The latest version of the firmware and the configuration software UMB ConfigTool.NET can be downloaded from our web page www.lufft.com. The software is available for Windows®, Android and can be converted in future to single Linux distributions. Please check our web page or ask for further information.

The following documents and software are available for download:

- Manual.....this document
- UMB-protocol.....Description of the protocol standard for UMB devices
- UMB ConfigTool.NET...Communication software UMB devices
- Firmware.....latest firmware for our devices

Additional software packages like SmartView are available too. Please ask for support!

3 Device description

3.1 Principles of the measurement technique

The snow depth sensor SHM 31 uses a phase shift method to precisely measure distances to objects. A laser diode inside the sensor sends out short laser pulses, which are intensity modulated with a defined frequency. The light is scattered from the target and detected with a photo diode. In contrast to the SHM 30 snow depth sensor, no continuous modulated laser light is generated but separate light pulses which have a defined phase relation. The advantage over the old method is that the contrast has been improved, allowing to reduce the dependency on ambient light. In addition, no speckle patterns are generated due to the short coherence time of the pulses, which otherwise can lead to lower precision in the distance measurement.

A small part of the transmitted laser light that hits an object is scattered back towards the sensor. This part of the light is compared to a reference signal to determine the distance to the object. In addition to the distance measurement, the sensor also evaluates the intensity of the signal. The distance depending normalization of the signal intensity is done by Lufft through the use of test targets. The procedure allows to differentiate surfaces with different reflectivity coarsely, for example, to distinguish snow and grass. Another aim of the normalisation is to make all SHM 31 sensors comparable to each other. More information on this topic can be found in the section: Testing and error descriptions.

3.2 Introduction to mounting and start-up

The snow depth sensor is mounted on a pole with the help of the mounting clamp. The installation on a pole arm is also possible but not required. The sensor is aligned towards the surface with a mounting angle (tilt angle α) which should lie in the range of 10° to 30° . A smaller angle can lead to inaccurate measurement results due to snow that has fallen off the sensor or pole. With an angle greater than 30° the laser beam hits the surface under a shallow angle, which can lead to vague and scattered results concerning the distance measurement.

The user starts an automatic reference measurement after installation of the sensor to determine the distance d_0 to the surface and the tilt angle α . The measured values are saved as reference values in the internal memory, see Figures 10 and 11. An already existing snow layer at the time of installation can be taken into account by setting an offset value in the sensor manually.

The snow depth h_1 is calculated by the following formula:

$$h_1 = h_r - h = h_r - \text{mean}(d) \cdot \cos(\alpha)$$

Here, h_r is the mounting height at the laser exit window and $\text{mean}(d)$ is the averaged result of the distance measurements.

Three different interfaces are implemented in the snow depth sensor SHM 31:

- RS485 (half duplex),
- RS232,
- SDI-12.

The RS232 interface can always be used parallel to the RS485 or SDI-12 interfaces. SDI-12 and RS485 interface cannot be used at the same time as they use a common connection wire. The device configuration defines which interface is active.

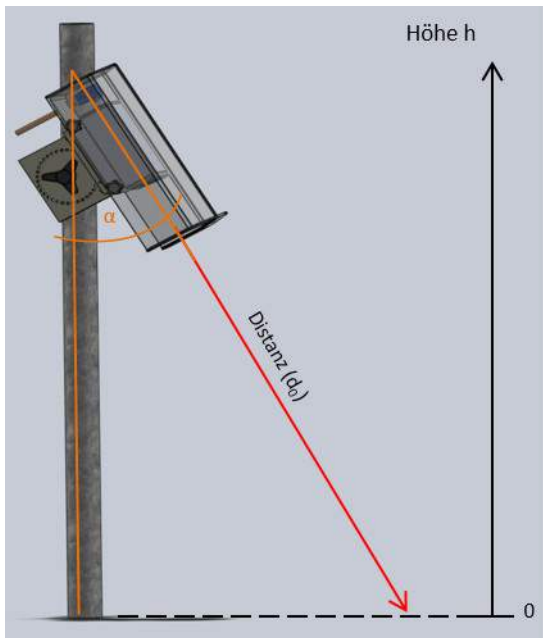

Figure 10: SHM31 mounting, measurement of distance and tilt angle

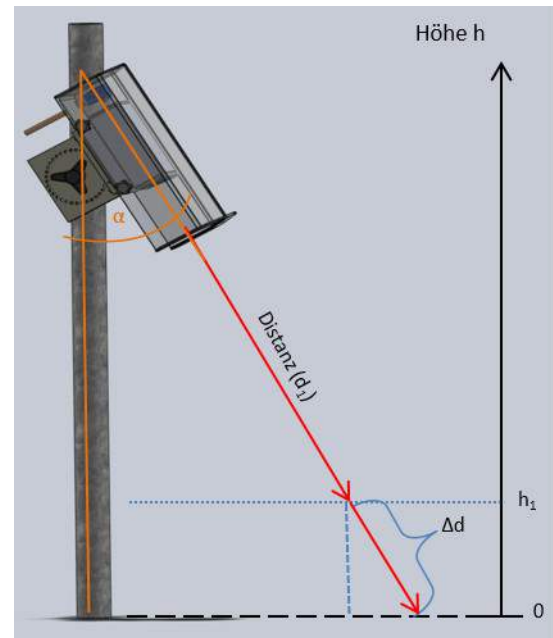

Figure 11: Determination of snow depth h_1 using angle and distance change

Types of communication:

The communication with the RS232 interface uses the UMB-ASCII 2.0 protocol. Data telegrams can be requested with a "polling method" or alternatively an automatic transmission mode can be activated.

The configuration of the RS232 interface is: 9600 Baud, 8N1 (8 bit, none parity, 1 stop bit, none handshaking).

The preset RS485 interface configuration is: 19200 Baud, 8N1. This interface allows communication with the UMB-ASCII 2.0 protocol (query mode or automatic transmission mode) or with the UMB-Binary protocol (only query mode). Various tools are available for the UMB-Binary protocol, for example, the Lufft UMB ConfigTool.NET, in addition to other Lufft specific communication and data based solutions like SmartView.

With firmware version v16 and newer RS485 communication via Modbus-RTU and Modbus-ASCII is also available.

The specifications for the SDI-12 interface can be found on page 47.

4 Generation of the measurement results

4.1 Measurement values (cur, avg)

Factory setting: The current measurement value is an average of the measurement values over 60s. The sensor performs a new measurement every 10 seconds, therefore the current value is an average of 6 measurements.

The measurement values which are labelled avg, min, max are averaged over 10 minutes with the factory settings.

4.2 Standard operation

The snow depth sensor is switched on and off by connecting/disconnecting the power supply.

After switching the sensor on it will require a couple of seconds before the communication to the sensor works. In the first seconds after a restart the sensor can receive UMB-Binary commands over the RS485 interface. This is true also if the user uses the SDI-12 protocol and ensures that it is always possible to exit the SDI-12 mode.

5 Installation

5.1 Installation instructions



Please avoid staring into the laser beam of the SHM 31.



Do not switch the SHM 31 on until the final assembly and alignment has been completed.

5.2 Assembly

The snow depth sensor is mounted on a mast using the available mast clamps. The sensor is oriented towards the surface. Its mounting angle (inclination angle α) should be between 10 and 30 degrees to prevent falling snow or icicles from the mast or sensor itself from affecting the measurement results (Fig. 15) If the angle is too large, the laser beam hits the ground too flat which will lead to blurred and inaccurate distance measurements. In addition, the accuracy of the snow depth calculation decreases due to the influence that larger angle measurements have.



Figure 12: SHM 31 sensors with mounting clamp 8365.610-11 (upper left), mounting clamp 8365.608-11 (lower left) and a SHM 30 Sensor with mounting clamp 8365.608-11 (middle right).

In the first installation step, the mast clamp itself should be fixed to the mast. After that the sensor can be mounted on the mast clamp using the 360° pattern disc and the tri star knob to position and adjust the sensor.

To connect the connection cable, first loosen the 3 knurled screws and remove the hood. Then the cable can be connected to the sensor and brought into position with the cable relief in the base plate, see 13 and 14. Tighten the plug firmly, please.



Figure 13: Mounting the connection cable to the sensor. The protective rubber sleeve is inserted into the recess of the floor plate during cable mounting. The amphenol connector can be adjusted to the angle (45° steps) when the white mounting ring is released.



Figure 14: Sensor mounted with hood. After the cable has been installed, the weather protection hood is fixed again over the 3 knurled screws.

The 360° pattern ring has a 10 degrees division and allows a rough inclination adjustment of the sensor. The 10° position can be adjusted by loosening the tri start knob slightly.

15 shows the general installation conditions

The criterion of not aligning the sensor with the sun has been somewhat softened with the SHM 31, since no restrictions have yet been established regarding the irradiation intensity due to sunlight reflected on the snow surface. In case of strong solar irradiation in the high mountains, however, higher measurement uncertainties can not be ruled out.

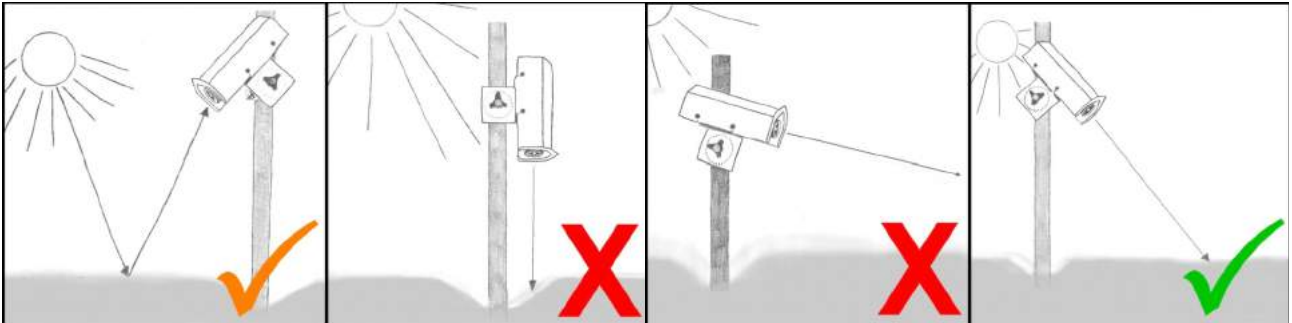

Figure 15: Mounting direction and angle of the SHM 31 for best performance.

In contrast to the SHM 30, the angle at the SHM 31 no longer has to be measured manually and communicated to the sensor. The SHM 31 has a built-in 3 axis acceleration sensor.

In the delivery state, the reference angle is used for the calculation of the snow height. After the installation, the reference angle must be determined together with the reference height during the zero measurement. In the normal measuring mode, however, it is also possible to use the current angle for the calculation instead of the reference angle. The corresponding channels for the angles are listed in the list of UMB channels in this manual.

6 Connections

An 8-pin connector is located at the rear of the sensor's internal housing. This is used to connect the supply voltage and the data interface.

A connection cable with a length of 15 m is offered separately.

6.1 Device connection

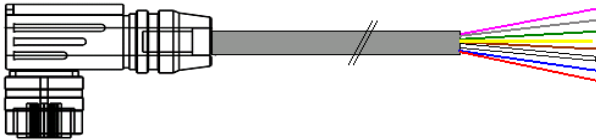

Figure 16: Connection cable (schematic), designation of the connector:
Amphenol C091 31 F008 101 2

Figure 17: View on soldering connection of the cable box with notch.

The Amphenol plug from the series C091D has a fixing ring (white). By loosening the ring the direction of the cable outlet to the groove can be varied in 45 ° steps.

6.2 Connector pin assignment

Interface cable/ wire	SHM 31	Description	Plug pin #
green	A_RS485	RS485 A	5
yellow	B_RS485/SDI12	RS485 B / SDI-12 Data Line	2
rose	RS232_TX	RS232 transmission line	1
blue	RS232_RX	RS232 receiver line	6
grey	GND	Ground RS232/ RS485	4
red	EXT_TRIG_IN	Heating release +	3
brown	V_IN_+	Supply voltage +	8
white	V_IN_-	Supply voltage – & SDI-12 ground	7

Table 3: Pin assignment SHM 31

6.3 Supply voltage

The SHM 31 should be supplied with a DC voltage of either 12 or 24 VDC \pm 10%.

6.4 Data interfaces

The sensor has a half-duplex 2 wire RS485 interface for the configuration, data query and firmware update. Furthermore a SDI-12 interface for configuration and data query and a RS232 interface for configuration, data query and a data auto send mode.

6.5 Heating release function

The sensor can be configured in a way that the heater is switched on only after a positive voltage signal has been applied to the pin heating release (typically 5 - 12 VDC for 12 VDC operation or 24 VDC for 24 VDC operating mode). This allows the user to deactivate the internal heating mode, for example in battery operation, independent of the internal heating configuration.

7 Start-up procedure

7.1 Important instructions during commissioning

The following points have to be considered:

Using the RS485 configuration and the UMB-ConfigTool.NET

- Learn how the UMB-ConfigTool.Net software works. The software can be downloaded from the Lufft homepage: <https://www.lufft.com/download/software-lufft-configtool-net/>. The software contains an online help function, which gives further explanations for the usage. A short instruction especially for the SHM31 is part of this chapter.



Laser safety

- Do not look into the laser directly while the sensor is on. For example, to make sure the laser is sending periodically, use a sheet of paper and hold it into the beam. Observe the laser beam only indirectly!

Mechanical and electrical connection

- Ensure that the SHM 31 has been connected and installed according to its intended use.

7.2 Switching the device on

As soon as the SHM 31 is supplied with power, it starts with its internal measuring cycle and can be addressed via RS232 and via RS485 or SDI-12 connection depending on the selected setting.

7.2.1 Configuration using RS232 or RS485

To access the sensor using the RS232 interface, a terminal program with UMB-ASCII 2.0 protocol can be used. With RS485 interface UMB-ASCII 2.0 and UMB-Binary protocols are possible options. We recommend the use of the ConfigTool.NET software with UMB-Binary protocol for a quick configuration of the sensor via RS485. The settings and parameter lists via UMB-Binary and UMB-ASCII 2.0 can be found in the following chapter.

7.3 UMB-ConfigTool.NET

The ConfigTool.NET is available for various operating system platforms. It can communicate with sensors via a serial, Bluetooth or network interface. The ConfigTool.NET allows the following communication steps:

1. Read individual UMB channels of the sensor, see also section 9.
2. Automatic retrieval, graphical display and storage of measured data
3. Perform firmware updates
4. Controlling the sensor via parameter lists
5. Control commands, such as reference value determinations, defrost mode,...

7.3.1 Basic installation using the ConfigTool.NET with serial interface

The following steps can be performed to set up ConfigTool.NET during initial installation:

1. Install and run the UMB ConfigTool.NET software
2. Check the settings for communication
 - a) On the ConfigTool.NET main panel select “Settings” located at the topright corner

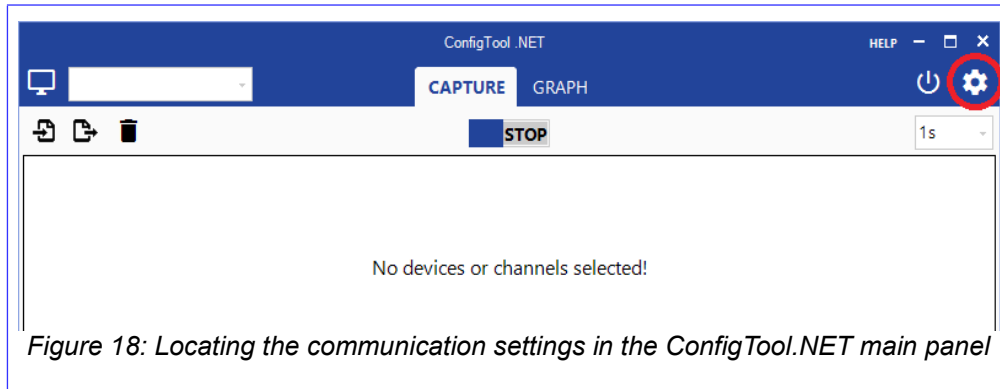

Figure 18: Locating the communication settings in the ConfigTool.NET main panel

- b) create or select a directory where you wish ConfigTool.NET to store the logfiles of your measurements into
- c) Use the device template download function to update the current list of available UMB channels. Lufft expands this list regularly regarding both, available languages and support of more recent sensors and sensor-options. This step requires an internet connection
- d) Confirm the settings by clicking “OK” or return to the main menu via “Cancel”

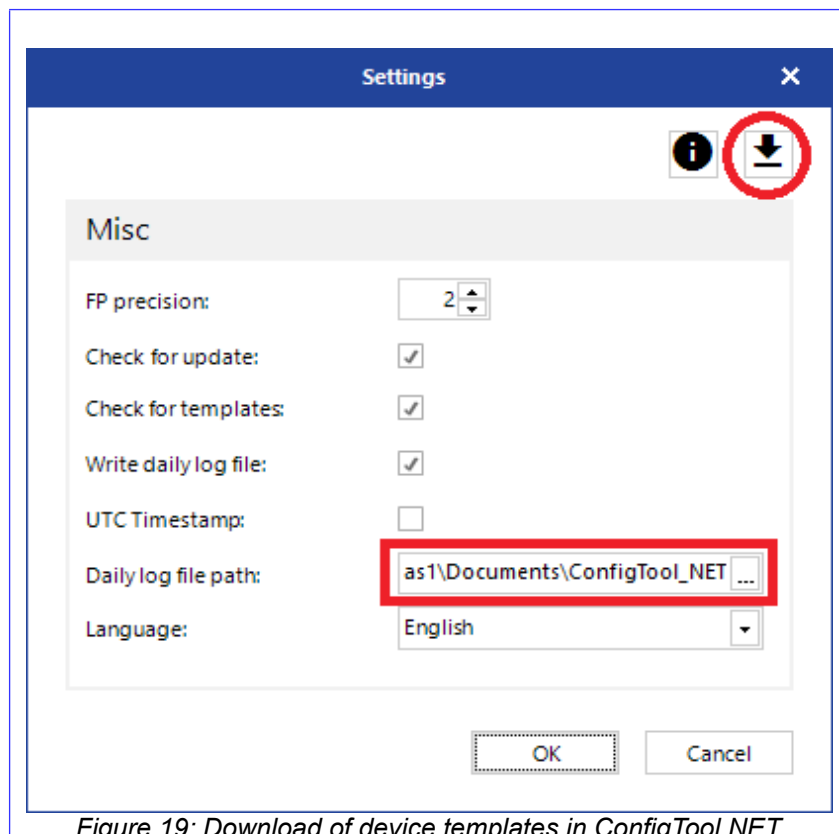

Figure 19: Download of device templates in ConfigTool.NET

3. ConfigTool.NET allows you to create different workspaces to manage your sensor settings and measurements. You can access the workspace options on the top left corner of the main panel.
 - a) Click “Edit workspaces...” in the main window. Unless no existing workspace has been selected a new workspace will be created.

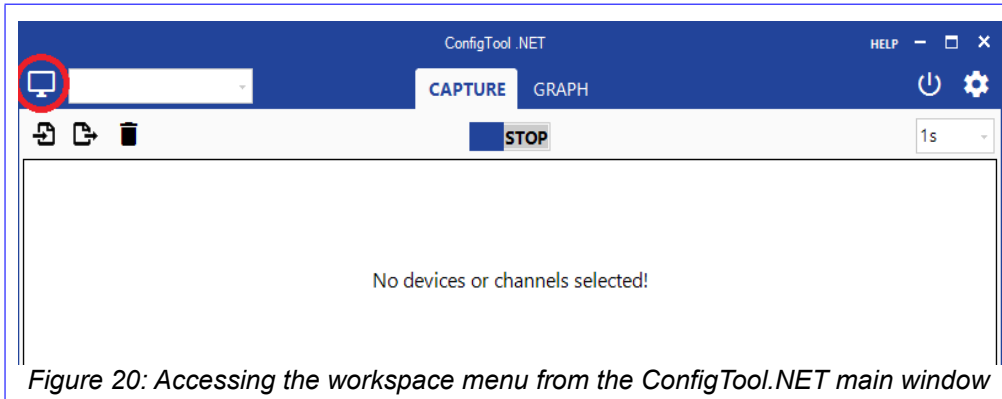



Figure 20: Accessing the workspace menu from the ConfigTool.NET main window

- b) Any new workspace requires certain connection settings which you can access by clicking the plug-shaped icon 

For now, please select “Serial” as connection type and the corresponding COM-port for your serial adaptor
- c) Please confirm any changes by clicking “OK” and return to the “Workspace Details” menu

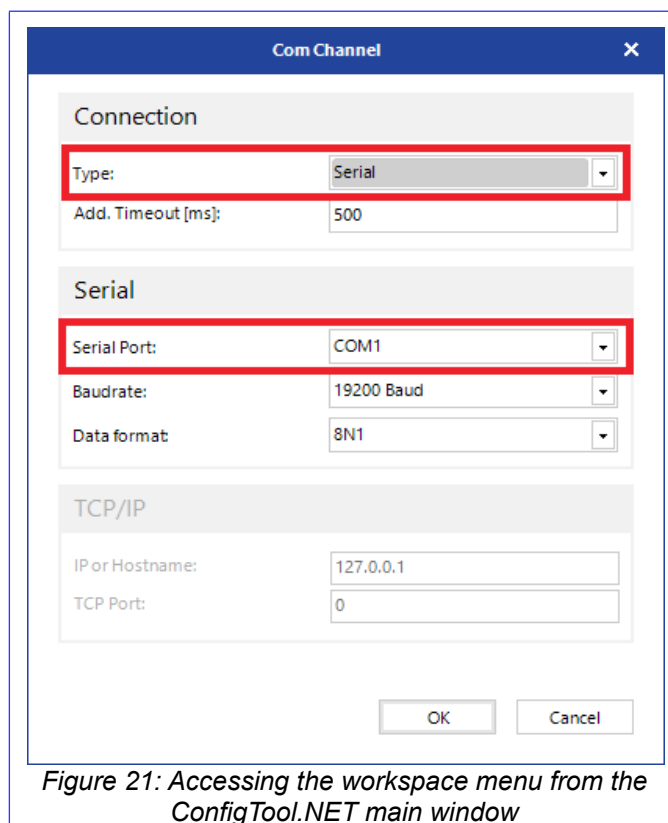

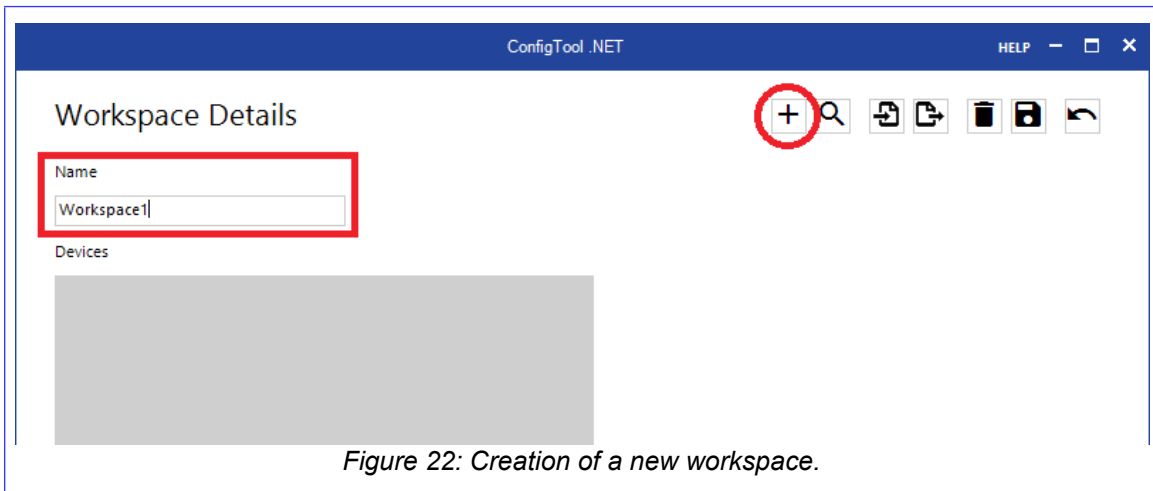
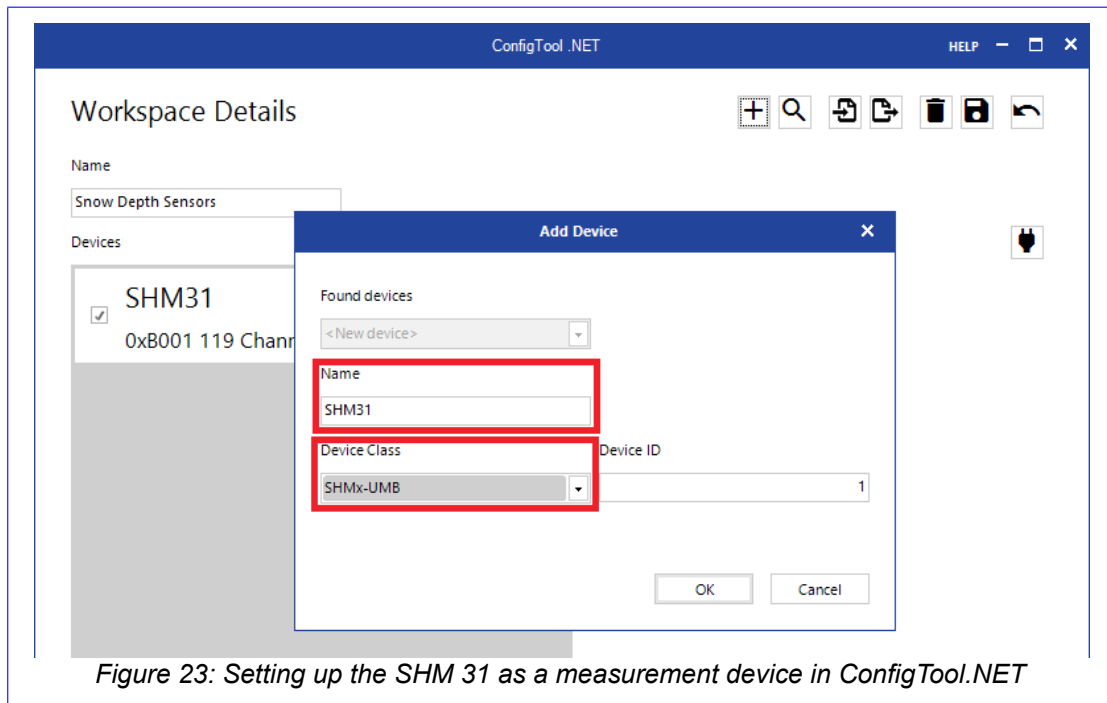

Figure 21: Accessing the workspace menu from the ConfigTool.NET main window

- d) At the “Workspace Details” menu, enter a name for the new workspace first. To add a measurement device to the new workspace click “Add Device”: 



- e) You will be lead to the “Add Device” menu. Enter a device name of your choice and select “SHMx-UMB” from the drop-down menu at “Device Address”.
- f) Confirm the settings to continue the device setup



- g) At the “Workspace Details” page, your SHM31 can now be found in the device list. Click the recently added sensor to continue to the “Device Details” page

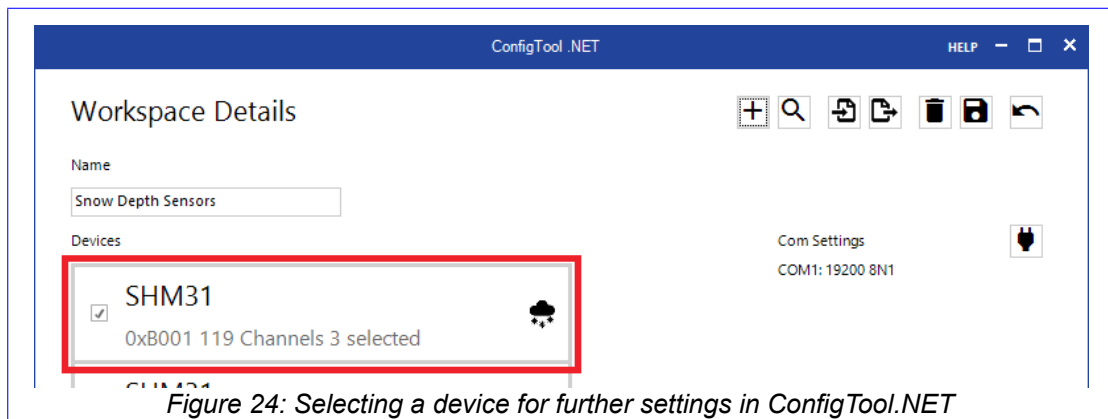

Figure 24: Selecting a device for further settings in ConfigTool.NET

- h) The following steps are necessary after mounting the device and will calibrate it for the operational use.
Click the rack wheel-symbol to access the “Device Settings” page

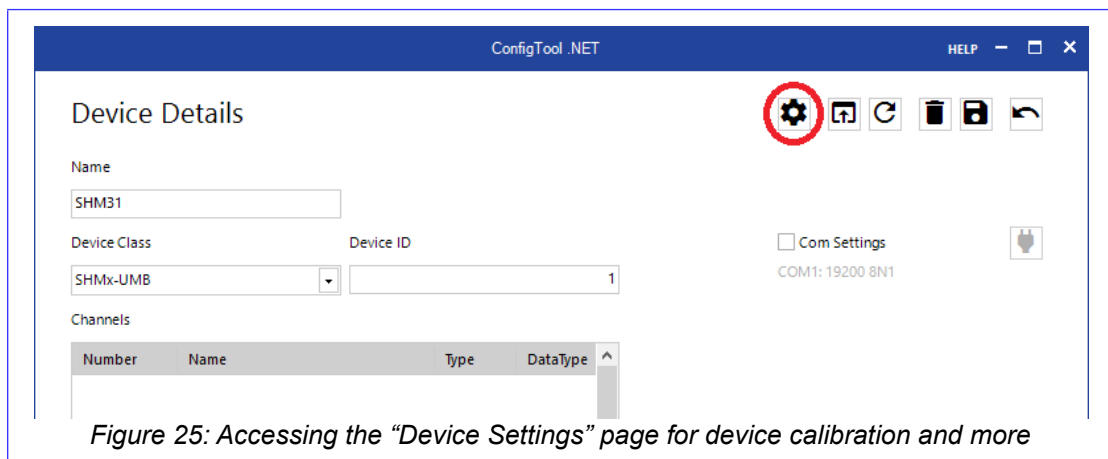



Figure 25: Accessing the “Device Settings” page for device calibration and more

- i) At the “Device Settings” page, click on “Adjustment”: 

Switch to the tab “Device Calibration”. Now, select the “Laser OFF” option and click “Start reference measurement”. The device will now automatically measure its angle and distance from ground as reference for any future measurements on this position. This process will take about two minutes. Once finished, select the measure mode option “REGULAR”

Use the “Back” button to return to the “Device Settings” page: 

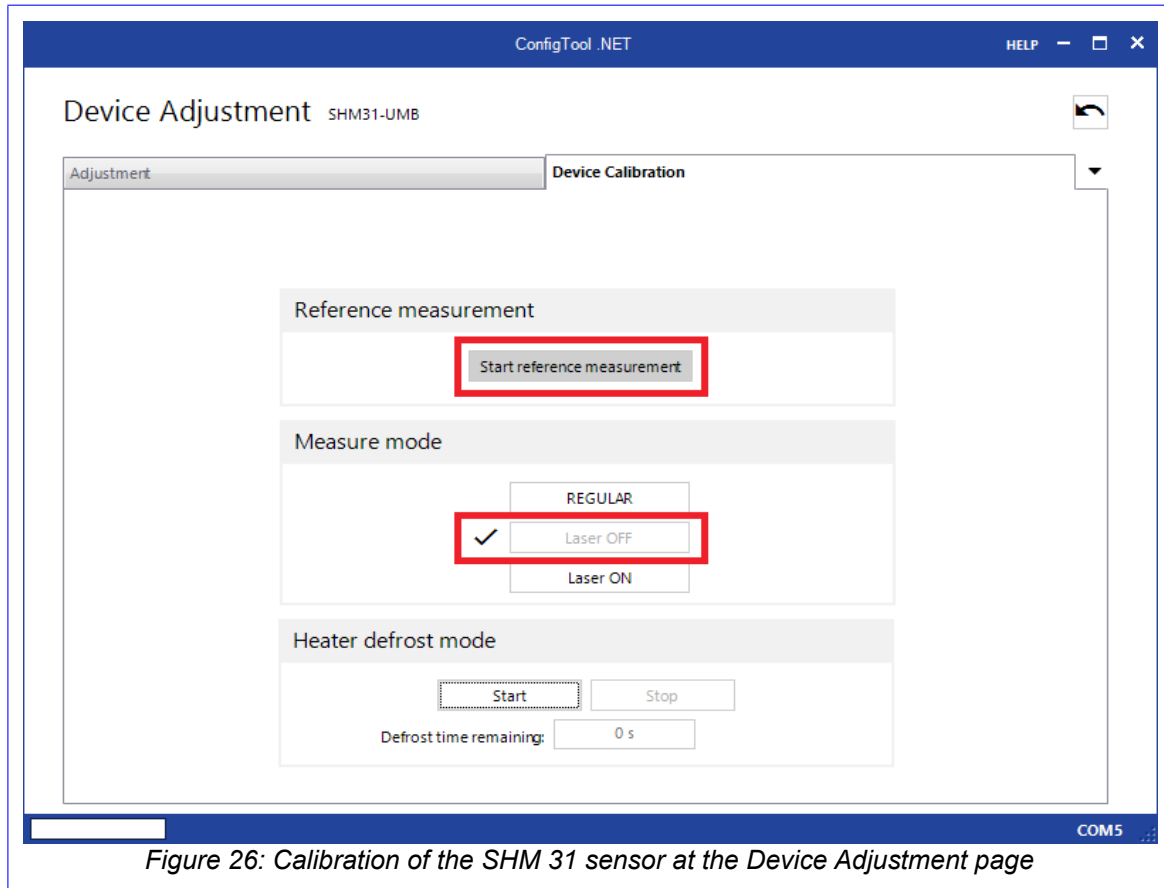

Figure 26: Calibration of the SHM 31 sensor at the Device Adjustment page

- j) You can now set further sensor parameters. At the “Device Settings” page, scroll down to the section “UMB-ASCII 2.0”. Use the “transmission interval [s]” parameter, to determine how often the sensor will provide new data for snow depth. Use the “laser interval [ms]” option in section “Laser parameters” to set the measuring interval for the sensor. All single measurements are averaged over the period of “transmission interval [s]”

Note: The “laser interval” value should not be set below 5000 ms due to extended measuring periods when targeting dark surfaces

A more detailed view at the “Device Settings” page can be found in the following chapter

Do not forget to transmit the new settings to the sensor by clicking the “Write to device” button:



Use “Back/Cancel” to return to the “Device Details” page

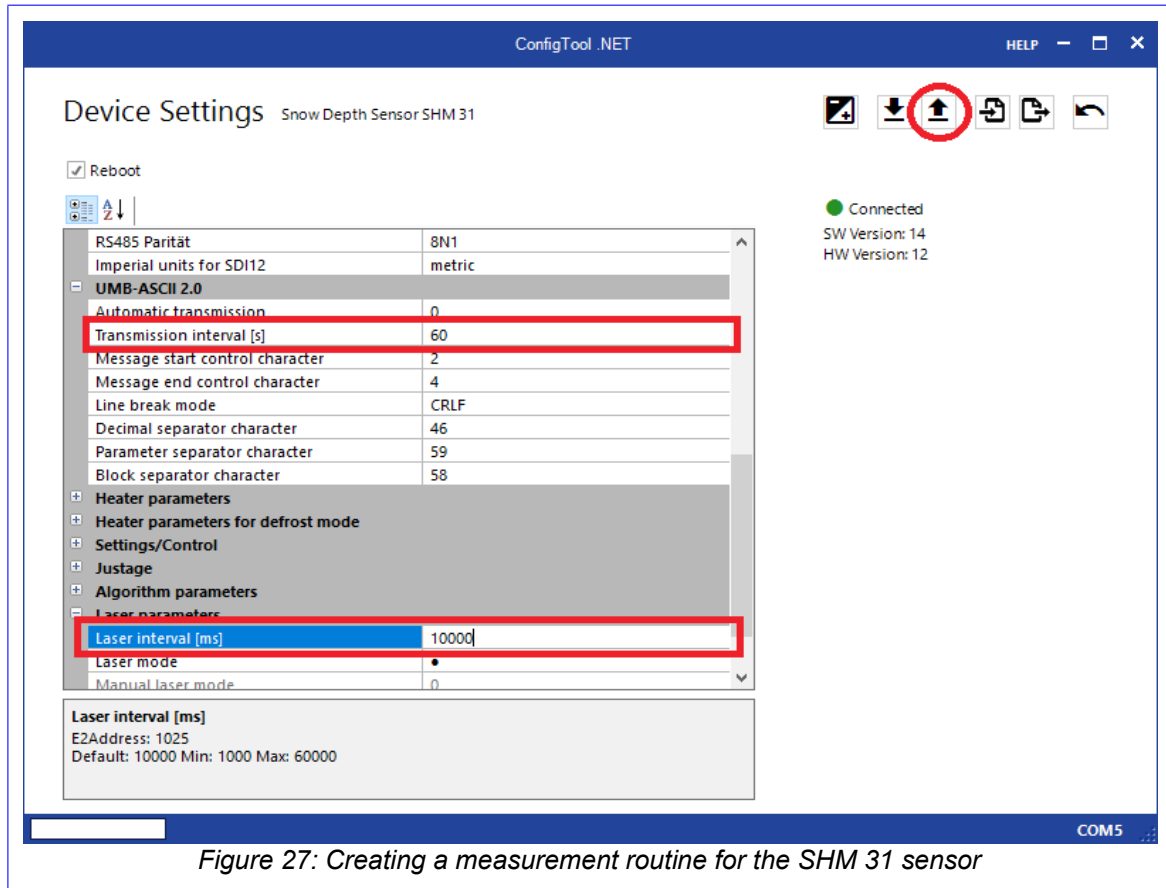

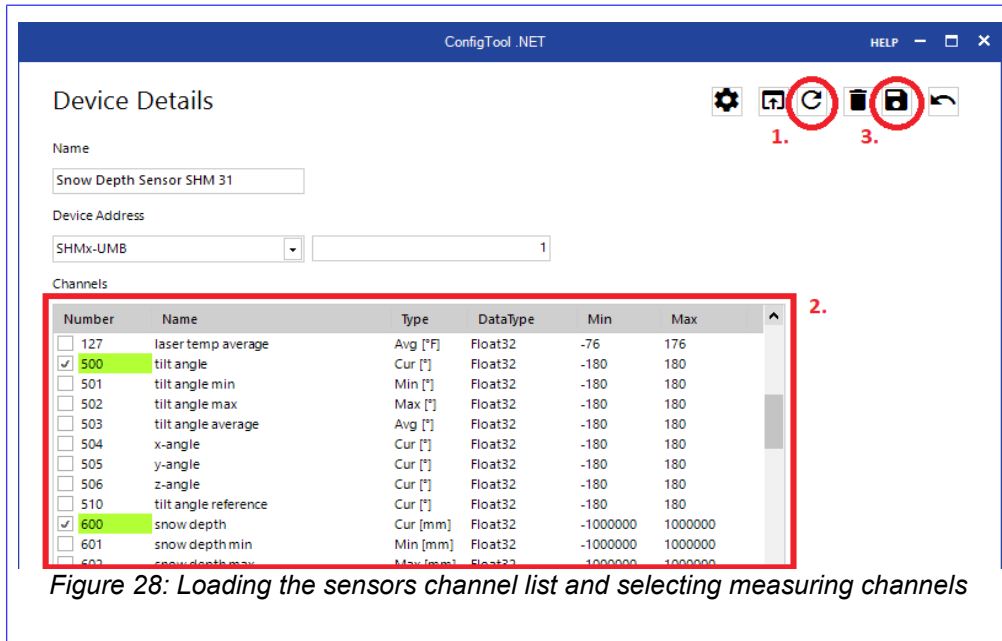

Figure 27: Creating a measurement routine for the SHM 31 sensor

- k) To check the function of the sensor you can select any channels which can be read out via ConfigTool.NET. You can get the list of available channels by clicking: 

For a first sensor check we recommend selecting the channels 500, 600, 650, 660, 700 and 800. You can later reconfigure the channel settings at any time. Press “Save Device” to return to the workspace menu.

- l) Make sure you save your workspace as well before returning to the main ConfigTool.NET page.



4. ConfigTool.NET now has prepared columns for your sensor readings and is ready to receive data. All the previously selected sensor channels should be shown as a table header. Use the drop-down menu on the right to select the interval at which sensor readings will be requested from the device. These readings will also be stored at the output logfile at the given interval. However, this option does not affect the actual measuring routine of the sensor. To start the data collection, move the switch to the “RUN” position. The sensor readings should now be displayed with the chosen measurement query rate

Note: To prevent data clones, the chosen query rate should never exceed the previously selected transmission interval of the sensor, as the sensor is programmed to always return its latest readings at any query event

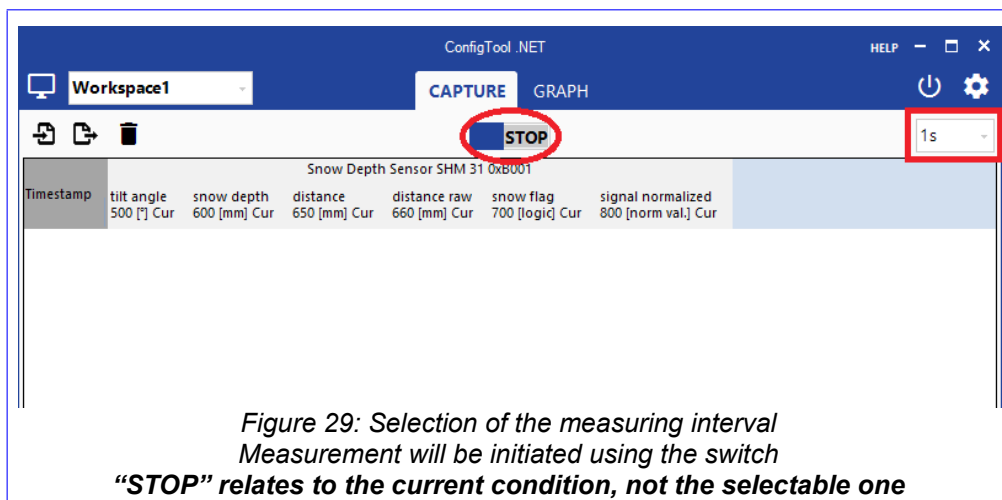

7.3.2 Adjusting SHM 31 sensor parameters

To take full advantage of the SHM 31 snow depth sensor, a deeper look at the sensors operational parameters is recommended. As seen in the previous chapter, the “Device Settings” page provides a full view of the sensors internally used parameters, thus providing a powerful tool to program the sensors measuring routine. The following table will give a brief overview of the *changeable* operational parameters in the “Device Settings” menu.

Parameter name	Default value	Domain	Description
Device parameters			
Device-ID	1	1 ... 255	Sensor-ID, to be set when using more than one sensor in the bus (e.g. UMB or SDI-12)
Description	snow depth sensor	max. char. 39	...
Station-ID	0	0 ... 99999	Additional ID (optional)
Baudrate	19200	[1200, ... , 57600]	Communication Baudrate.
Protocol	umb-binary	umb-binary, umb-ascii 2.0, sdi-12, modbus	The communication protocol used by the sensor
Timeout for protocol change [min.]	10	1 ... 60	Duration after which the protocol is being reactivated in the case of a temporary changeover
RS485 Parity	8n1	8n1, 8e1, 7e1 (sdi-12), 8n2	Serial port parity setting
Imperial units for SDI-12	metric	metric, sdi-12 us-units	...
UMB-ASCII 2.0			
Automatic transmission	0	0 ... 99	0 = polling mode, 1 = available data telegram
Transmission interval [s]	60	0 ... 65535	Processing rate for measurements (calculation of snow depth, averages, etc. and preparing the data string for transmission)
Message start control character	2	0 ... 127	Protocol start character
Message end control character	4	0 ... 127	Protocol end character
Line break mode	crlf	cr, lf	Protocol line feed character
Decimal separator char.	46	0 ... 127	Decimal mark character used
Parameter separator character	59	0 ... 127	Parameter delimiter character used
Block separator character	58	0 ... 127	Block delimiter character used

Parameter name	Default value	Domain	Description
Heater parameters			
Operating mode of the window	automatic	off, automatic,	Heater mode for the sensor window

Parameter name	Default value	Domain	Description
heater		defrost	
Operating mode of the block heater	automatic	off, automatic, defrost	Heater mode for the sensor housing
Target temperature of the window heater [°C]	20	-50 ... 50	Mean target temperature of window
Target temperature of the block heater [°C]	7.5	-50 ... 50	Mean target temperature of housing
Hysteresis for window heating [°C]	2.5	0 ... 5	Switching point below (heating on) and above (heating off) target temperature
Hysteresis for block heating [°C]	2.5	0 ... 5	Switching point below (heating on) and above (heating off) target temperature
Voltage threshold of heating [V]	17	12 ... 19	If internal supply voltage exceeds this value, heaters are operated in 24 V mode instead of 12 V mode
Heating control via external input	disabled	enabled, disabled	If enabled wire <i>heating release</i> (+) needs to be connected to (+), see section 6.5
Heater parameters for defrost mode			
Target temperature of the window heater defrost mode [°C]	25	-50 ... 50	The window heater will maintain the selected temperature during defrost mode
Target temperature of the block heater defrost mode [°C]	35	-50 ... 50	The block heater will maintain the selected temperature during defrost mode
Hold time for window defrost [min.]	15	1 ... 255	Select the duration of the window defrost procedure
Hold time for block defrost [min.]	15	1 ... 255	Select the duration of the housing defrost procedure
Automatic defrost after startup	no	n/y	...
Settings/Control			
Standby	-	-	Not yet implemented
Auto start command	MST	MST, LON	Boot up mode for the sensor. MST = starting measurements LON = laser on
Scaling factor	1	0 ... 40000	Change of units, e.g. meter (sf = 1) to foot (sf = 3.2808399). After a change of the scaling factor SCF the parameters AOF, MSD and the distance value in the telegram are converted into the new units.
Channel average count	10	1 ... 120	Number of measurements used to calculate the values for averaged UMB channels (*_avg) and the min/max values
Justage			
Reference height [mm]	0	-20000 ... 20000	Will be automatically set during the device calibration procedure

Parameter name	Default value	Domain	Description
			or can be set manually
Reference angle [°]	0	-180 ... 180	Will be automatically set during the device calibration procedure or can be set manually
Algorithm parameters			
Use accelerometer angle	0	0, 1	0 = use reference angle from calibration, 1 = use the sensors accelerometer value as reference during each measurement
Signal threshold for snow	130	0 ... 255	Sets the signal intensity as threshold for the snow-flag
Maximum snow depth change [mm]	20	-10000 ... 10000	Maximum of allowed snow depth changes between two measurements. Use 10000 as value for installation to prevent error messages due to vast changes in measured distances (e.g. due to obstruction).
Accept time for changed snow depth [s]	600	0 ... 65535	Time interval for the snow depth value to be accepted, although exceeding the sensors maximum snow depth change rate
Laser parameters			
Laser interval [ms]	10000	1000 ... 60000	Time interval for the laser-measurement of the sensor. Use below 5000 ms not recommended!
Laser mode	-	-	Not yet implemented

Table 4: Parameter settings for the SHM31

8 Communication via UMB-ASCII 2.0

This section describes the communication and output of measurement values of the SHM 31 with the UMB-ASCII 2.0 data protocol. The communication is available via the RS232 and the RS485 interface.

8.1 Syntax

The parameters in angle brackets are optional:

```
Query <Add>:<Nr>:<Payload><CR><LF>
Reply <STX><Add>:<Nr>:<Payload>:< UMB Status>:<Checksum><CR><LF><EOT>
Payload <Cmd>[;<Param0>;...;ParamN][=<Value0>;...;<ValueN>]
```

The individual blocks of the protocol are separated using a colon. This block delimiter can be changed. <Add> is the UMB address of the sensor, 4 hex symbols with leading zeros, in the range 0001-FFFF. Messages with a wrong address are ignored by the sensor. The block <Nr> can be set to two arbitrary hex symbols. The sensor adopts these symbols and includes them in the reply. <Nr> can be used as a time reference, for example, in case query and reply are not received directly after each other. <Payload> is the actual data of the telegram. It includes the command with its parameters and values. The <Status> block consists of two hex symbols with leading zeros. <Status> contains the error code and <Payload> the command if the command is unknown or incorrect. Query and reply end with the characters <CR><LF>, which can be changed. The reply of the sensor is additionally framed with the control characters <STX> and <EOT>.

The Payload contains the command and its parameters. Commands can have one or more parameters, separated by a semicolon. This delimiter character can be changed. An equal sign in the payload indicates a write command. The value <Value> can be one of the supported data types including strings, depending on the command. More than one value can be transferred using semicolons as a delimiter. The decimal mark is a decimal point but can be changed by the user.



The length of the query should be less than 128 characters, the reply cannot be longer than 512 characters.

8.2 Checksum

Replies from the sensor include a checksum <Checksum> to ensure the integrity of the transmitted data. The checksum is a complement on two of the 8-bit sum of all characters, including control characters but without the checksum itself. The checksum consists of two hex symbols with leading zero.

8.3 Examples

For the following examples it is used: <Add> = **B001**, <Nr> = **4E** (default: 00)

Reset: B001:4E:RST<CR><LF>

```
<STX>B001:4E:RST:00:<Checksum><CR><LF><EOT>
```

Auto Transmit Interval (Evaluation interval):

```
B001:4E:ATI=60<CR><LF>
```

```
<STX>B001:4E:ATI=60:<Checksum><CR><LF><EOT>
```

Polling (Request of the data telegram):

```
B001:4E:SS;1<CR><LF>
<STX>B001:4E:SS;1=085;003.0117;+02.1253;185;+15;17.8;00:00:94
<CR><LF><EOT>
```

Read Channel (Read a UMB measurement channel):

```
B001:4E:CHN;100<CR><LF>
<STX>B001:4E:CHN;100=+23.45:00:<Checksum><CR><LF><EOT>
```

```
B001:4E:CHN;110<CR><LF>
<STX>7001:4E:CHN;110:28:<Checksum><CR><LF><EOT>
(Channel busy)
```

```
B001:4E:CHN;523<CR><LF>
<STX>B001:4E:CHN;523:24:<Checksum><CR><LF><EOT>
(Channel unknown)
```

8.4 Description of the data telegram #1 with an example

<Add>:<Nr>:Payload:UMB status:checksum of the data telegram #1:
B001:4E:SS;1=085;003.0117;+02.1253;185;+15;17.8;15:00:8E

Example	Length in bytes	Description
B001:4E:SS;1=	13	Repeat request command, address, ...
085	3	Telegram number
;	1	Delimiter, user adjustable
003.0117	8	First 8 digits of the serial number
;	1	Delimiter, user adjustable
+02.1253	8	Snow depth
;	1	Delimiter, user adjustable
185	3	Signal strength [0;255]
;	1	Delimiter, user adjustable
+15	3	Window temperature
;	1	Delimiter, user adjustable
17.8	4	Tilt angle
;	1	Delimiter, user adjustable
15:	3	Error code (E15)
00:	3	UMB status code
8E	2	Checksum
	56	Sum

Table 5: ASCII telegram example

8.5 Angle adjustment

For the automatic calibration the following commands have to be sent consecutively:

MEN, ARV and **MST**

For the manual angle adjustment the commands **AOF** and **AAN** are used.

8.6 Switching from UMB protocol to ASCII protocol

The UMB hex-code for switching from the UMB protocol to the ASCII protocol is as follows:

01 10 01 B0 01 F0 06 02 22 10 75 00 01 09 03 71 25 04

Afterwards the sensor needs a reset. The UMB hex-code for the reset is:

01 10 01 B0 01 F0 03 02 25 10 10 03 EC 44 04

Examples for the Bray terminal program: The two codes are as follows:

\$01\$10\$01\$B0\$01\$F0\$06\$02\$22\$10\$75\$00\$01\$09\$03\$71\$25\$04

\$01\$10\$01\$B0\$01\$F0\$03\$02\$25\$10\$10\$03\$EC\$44\$04

Remark: In the Bray terminal program hex values are transferred with a leading \$ character, ASCII-codes with a # character.

8.7 ASCII command overview

Command UMB-ASCII 2.0	Standard value	Read, write, command	Name	Description
IFO		R	Info	Query of the sensor information
SI		RW	Stations-ID	Stations-ID
NAM		R	Name	
SRN		R	Serial number	Lufft serial number
DSC		R	Description	Description

Table 6: Sensor information

Query of the sensor information (IFO). From parameter 20 on a valid channel number has to be included as a second parameter.

Examples

B001:4E:IFO;12 transmits the version number, or

B001:4E:IFO;20;100 transmits the name of UMB channel 100

List of currently included parameters:

- 10 ASCII2_INFO_NAME
- 11 ASCII2_INFO_DESC
- 12 ASCII2_INFO_VER
- 13 ASCII2_INFO_EXT
- 14 ASCII2_INFO_E2SIZE
- 15 ASCII2_INFO_NUMBEROFCHANNELS
- 16 ASCII2_INFO_CHANNELNUMBERS* (starting FW 1.3)
- 20 ASCII2_INFO_CHAN_NAME
- 21 ASCII2_INFO_CHAN_RANGE
- 22 ASCII2_INFO_CHAN_UNIT
- 23 ASCII2_INFO_CHAN_DATATYPE
- 24 ASCII2_INFO_CHAN_TYPE
- 30 ASCII2_INFO_CHAN_INFO

*) Remark: requires an additional parameter which defines which part (block) of the channels should be transmitted. There are 4 blocks for the SHM31. Example: ...IFO;16;0

Command UMB-ASCII 2.0	Standard value	Read, write, command	Name	Description
MEN		C	MeasurementEnd	Cancels the current measurement, and the calculation and transmission of telegrams
MST		C	MeasurementStart	Starts the automatic snow depth measurement
SS<;> <SS-Nr>	1	C	Standard-Set, Telegram Format	Requests the current telegram (standard format 1)
ATI	60	RW	AutoTransmitInterval	Repetition rate of measurements (calculation of snow depth, prepare telegram and send if applicable)
ATM	0	RW	AutoTransmitMode	0=polling, 1,2,..=telegram format number
PST	<STX>	RW	Protocol: Start character	
PEN	<EOT>	RW	Protocol: End character	
PCR	<CR><LF>	RW	Protocol: line feed character	
PDS	.	RW	Protocol: decimal mark character	
PBS	:	RW	Protocol: block delimiter character	
PPS	;	RW	Protocol: parameter delimiter character (also for telegram values)	
CHN<;><ChnNum>		R	Channel; Channel Number	Query a UMB channel

Table 7: ASCII parameters for measurements and data transmission

Command UMB-ASCII 2.0	Standard value	Read, Write, Command	Name	Description
ID	1	RW	ID	UMB Device-ID (1-255)
BAU	6	RW	Baud rate	Query / set the baud rate for RS485 / SDI-12 interface 2: 57600 4: 28800 6: 19200 8: 14400 12: 9600 24: 4800 48: 2400 96: 1200 (Baud rate = 115200/n) A change of the baud rate requires a reset of the device.
SCF	1	RW	ScalingFactor	Change of units, e.g. meter (sf=1) to foot (sf=3,2808399). After a change of the scaling factor SCF the parameters AOF, MSD and the distance value in the telegram are converted to the new units. The scaling factor is defined in the range [0;40000].
PRT		RW	Protocol	User-Interface RS485/SDI-12 (0=UMB, 9=ASCII2.0, 3=SDI-12, 5=Modbus-RTU, 6=Modbus-ASCII)
ASC	MST	RW	AutoStartCommand	Boot up mode of the sensor, e.g. MST=start snow depth measurement. Current values: ASC := {MST , LON}
STB	-	C	NA	Function not yet implemented.
LON		C	Laser On	Switch laser into blinking mode for alignment
LOF		C	Laser Off	Switch laser off after LON command. To start the measurement, send MST afterwards.
RST		C	Reset	Reset immediately.
RST=<Value>		C	Reset in <Value> ms	Reset after<Value> ms
RSD		C	Reset default values	Reset to default values
UMB		C		Switch to UMB temporarily
CAC	10	RW	channel_average_counts	Number of measurements used to calculate the averaged UMB channel values (*_avg) and for the min and max values.

Table 8: ASCII parameters for settings and control

Command UMB-ASCII 2.0	Standard value	Read, Write, Command	Name	Description
ARV		C	AdjustmentReferenceValues	Measures the current distance and tilt angle and sets the adjustment offset "AOF" and the adjustment angle "AAN".
ARH		C	AdjustmentReferenceHeight	Measures the current distance and determines the adjustment offset "AOF" using the currently set adjustment angle.
AOF	0	RW	AdjustmentOffset	Offset (distance to surface (vertical)), see "ARV".
AAN	0.0	RW	AdjustmentAngle	Installation angle (0.0° corresponds to vertical measurement towards the ground surface).
ASH<;><Nr>		R	Adj.SignalHighReflectivity <#> corresponds to the distances (1=a, 2=b, ..., 5=e)	Signal calibration for targets with 85% reflectivity in 5 distances, <#> = [1..5]
ASL<;><Nr>		R	Adj.SignalLowReflectivity <#>	Signal calibration for targets with 6% reflectivity in 5 distances, <#> = [1..5]

Table 9: ASCII parameters for adjustment

Command UMB-ASCII 2.0	Standard value	Read, Write, Command	Name	Description
HEP	0	RW	HeaterEnablePin	Use the hardware trigger for the heater (EXT_TRIG_IN): 0=off, 1=on
HBM	1	RW	HeaterBlockMode	Block heater mode: 0=off; 1=automatic: heat to set temperature and maintain; see "HBT", "HBH"; 2=enable defrost heating cycle once; 3=stop the current defrost heating cycle and switch to previous mode (0 or 1).
HBT	7,5	RW	HeaterBlockTemperature	Set temperature in °C used in automatic heater mode

Command UMB-ASCII 2.0	Standard value	Read, Write, Command	Name	Description
				("HBM"=1).
HBH	2,5	RW	HeaterBlockHysteresis	Hysteresis; temperature is kept within this range in the automatic heater mode ("HBM"=1).
HWM	1	RW	HeaterWindowMode	Window heater mode: 0=off; 1=automatic: heat to set temperature and maintain; see "HWT", "HWH"; 2=enable defrost heating cycle once; 3=stop the current defrost heating cycle and switch to previous mode (0 or 1).
HWT	20	RW	HeaterWindowTemperature	Set temperature in °C used in automatic heater mode ("HWM"=1).
HWH	2,5	RW	HeaterWindowHysteresis	Hysteresis; temperature is kept within this range in the automatic heater mode ("HBM"=1).
HDS		C	HeaterDefrostStart	Start defrost mode temporarily (with values "HDP", "HDR", "HDB", "HDW" for both heaters (block and window)).
HDE		C	HeaterDefrostEnd	Stop the defrost mode and switch "HBM" and "HWM" back to their previous values.
HDM	1	RW	HeaterDefrostMode	Defrost mode: 0=always off, 1=during sensor start (with values "HDP", "HDR", "HDB", "HDW" for both heaters (block and window)).
HDP	15	RW	HeaterDefrostPeriod Block	Defrost: duration of defrost heating cycle in minutes for the block heater.
HDR	15	RW	HeaterDefrostPeriod Window	Defrost: duration of defrost heating cycle in minutes for the window heater.

Command UMB-ASCII 2.0	Standard value	Read, Write, Command	Name	Description
HDB	35	RW	HeaterDefrostBlock	Defrost: set temperature in °C for the block heater.
HDW	25	RW	HeaterDefrostWindow	Defrost: set temperature in °C for the window heater.

Table 10: ASCII parameters for heater control

Command UMB-ASCII 2.0	Standard value	Read, Write, Command	Name	Description
LMM	0	RW	Laser Measurement Mode	Mode for laser measuring time control: 0=automatic measurement
LMI	10000	RW	Laser Measurement Interval	Laser measuring interval in milliseconds.
SIT	130	RW	Signal Intensity Threshold	Sets the signal threshold that is used to activate the "snow flag" in the data telegram.
UAA	0	RW	Use Accelerometer Angle	Choose tilt angle mode, 0=use reference angle "AAN", 1=use currently measured value of the inclination sensor.
MSD	0,02	RW	Maximal SnowDepth Difference	Maximally allowed difference between two snow depth measurements. The factory set value is 0.02 m. During installation it is recommended to set the value to 10 m to simplify the installation and prevent errors E65/ E66. After installation the value can be set back to 0,02 (=2 cm if sf=1). This corresponds to a sensible snow depth change rate of 2 cm per minute.
MSA	600	RW	Maximal SnowDepth Acceptance time	Time after which the new snow depth is accepted although the difference was greater than "MSD".

Table 11: ASCII parameters for the algorithms

9 UMB Communication

9.1 UMB Factory settings

The factory UMB communication settings of the SHM 31 sensor are as follows:

Class ID:..... 11 (fixed)

Device ID:..... 1 (corresponds to address B001 (hex) = 45057)

Baud rate:..... 19200

RS485 protocol:..... UMB binary

9.2 Overview measuring channels

The channel assignment is valid for online data requests with the UMB protocol.

UMB channel					
act	min	max	avg	Measured variable (float32)	Unit
100	101	102	103	block temperature	°C
104	105	106	107	block temperature	°F
108	109	110	111	ambient temperature (window inside)	°C
112	113	114	115	ambient temperature (window inside)	°F
120	121	122	123	laser temperature	°C
124	125	126	127	laser temperature	°F
500	501	502	503	tilt angle	°
504				x-angle	°
505				y-angle	°
506				z-angle	°
510				tilt angle reference	°

Table 12: Measuring channels SHM31: 100 – 599 (float 32 data type)

UMB channel					
act	min	max	avg	Measured variable (float32)	Unit
600	601	602	603	snow depth	mm
604	605	606	607	snow depth	cm
608	609	610	611	snow depth	m
612	613	614	615	snow depth	inch
650				distance	mm
651				distance	inch
660				distance raw	mm
661				distance raw	inch
690				sensor altitude	mm

Table 13: Measuring channels SHM31: 600 - 690 (float32 data type)

UMB channel						
act	min	max	avg	Measured variable	Data type	Unit
700				snow flag	uint8	logic
800	801	802	803	signal normalized	uint8	norm value
890				snow signal threshold	uint8	norm value
4000				device status <i>if not 0 please contact support</i>	uint16	digits
4003				RS485 status <i>if not 0 please contact support</i>	uint16	digits
4007				system time	uint32	s
4010				heater block state 0: off 1: active in 12 V mode 2: active in 24 V mode 3: defrost mode (12 V) 4: defrost mode (24 V) 5: heating via external input EXT_TRIG_IN deactivated 6: deactivated due to internal voltage control error 7: deactivated due to wrong configuration or faulty temp. value	uint16	digits
4011				internal NTC temp <i>raw value for internal temperature</i>	float32	°C
4013				block defrost time <i>remaining time in defrost mode</i>	uint16	s
4020				heater window state 0: off 1: active in 12 V mode 2: active in 24 V mode 3: defrost mode (12 V) 4: defrost mode (24 V) 5: heating via external input EXT_TRIG_IN deactivated 6: deactivated due to internal voltage control error 7: deactivated due to wrong configuration or faulty temp. value	uint16	digits
4021				external NTC temp <i>raw value for external temperature</i>	float32	°C
4023				window defrost time <i>remaining time in defrost mode</i>	uint16	s
4100				shm31 error <i>the error codes for the device are listed in table 26</i>	uint8	shm30 code
4101				shm31 error (current) <i>internal error handling</i>	uint8	shm30 code

Table 14: Measuring channels 700 - 4999

UMB channel						
act	min	max	avg	Measured variable	Data type	Unit
5000				laser gain	uint8	raw code
5001				laser sig. strength	int32	µV
5002				laser distance	float32	mm
5003				laser temperature	float32	°C
5004-5030				laser error statistic	uint32	raw code
10000				vin monitor	float32	V
10001				15V monitor	float32	V

Table 15: Measuring channels starting from 5000

9.3 Communication in RS485 binary protocol

Lufft offers tools to communicate in UMB binary mode with our sensors. The ConfigTool.net was already described here. In addition, the SmartView Collector is a database tool to collect the measured data of Lufft's UMB sensors. In several data loggers from Lufft, Sutron,.. the UMB protocol is also implemented.

Instead of using these software or hardware solutions a direct binary communication with UMB sensors is possible. In the following section a short introduction is presented. The general description of the binary UMB protocol for all commands and the exact mode of operation can be found in the UMB protocol manual (available for download at www.lufft.com).

9.3.1 Framing

The data frame is constructed as follows:

1	2	3 - 4	5 - 6	7	8	9	10	11 ... (8 + len) optional	9 + len	10 + len 11 + len	12 + len
SOH	<ver>	<to>	<from>	<len>	STX	<cmd>	<verc>	<payload>	ETX	<cs>	EOT

SOH	Control character for the start of a frame (01h); 1 byte
<ver>	Header version number, e.g.: V 1.0 →<ver> = 10h = 16d; 1 byte
<to>	Receiver address; 2 bytes
<from>	Sender address; 2 bytes
<len>	Number of data bytes between STX and ETX; 1 byte
STX	Control character for the start of payload transmission (02h); 1 byte
<cmd>	Command; 1 byte
<verc>	Version number of the command; 1 byte
<payload>	Data bytes; 0 – 210 bytes
ETX	Control character for the end of payload transmission (03h); 1 byte
<cs>	Check sum, 16 bit CRC; 2 bytes
EOT	Control character for the end of the frame (04h); 1 byte

Control characters: SOH (01h), STX (02h), ETX (03h), EOT (04h).

9.3.2 Addressing with Class and Device ID

Addressing takes place by way of a 16-bit address. This breaks down into a Class ID and a Device ID.

Address (2 bytes = 16 bit)			
Bits 15 – 12 (upper 4 bits)		Bits 11 – 8 (middle 4 bits)	Bits 7 – 0 (lower 8 bits)
Class ID (0 to 15)		Reserve	Device ID (0 – 255)
0	Broadcast		0 Broadcast
11	SHM31 Snow Depth Sensor		1 - 255 Available
15	Master or control devices		

ID = 0 is provided as broadcast for classes and devices. Thus, it is possible to transmit a broadcast on a specific class. However this only makes sense if there is only one device of this class on the bus; or in the case of a command, e.g. reset.

9.3.3 Examples for Creating Addresses

If, for example, you want to address a SHM31 with the device ID 001, it takes place as follows:

The class ID is: 11d = Bh; the device ID is: 001d = 001h

Putting the class and device IDs together gives the address B001h (45057d).

9.3.4 Example of a Binary Protocol Request

If, for example, a sensor with the device ID 001 is polled from a PC for the current snow depth, this takes place as follows:

Sensor:

The target address for the SHM31 is B001h.

PC:

The class ID for the PC (master unit) is 15 = Fh; the PC ID is e.g. 001d = 01h.

Putting the class and device IDs together gives a sender address of F001h.

The length <len> for the online data request command is 4d = 04h;

The command for the online data request is 23h;

The version number of the command is 1.0 = 10h.

The channel number is in <payload>; as can be seen from the channel list in section 9.2 the current snow depth in cm is in channel 604d = 25Ch.

The calculated CRC is 5930h.

SOH	<ver>	<to>		<from>		<len>	STX	<cmd>	<verc>	<channel>		ETX	<cs>		EOT
1	2	3	4	5	6	7	8	9	10	11	12	13	14	15	16
01h	10h	01h	B0h	01h	F0h	04h	02h	23h	10h	5Ch	02h	03h	30h	59h	04h

Table 16: UMB binary example, query command to the sensor

SOH	<ver>	<to>		<from>		<len>	STX	<cmd>	<verc>	<status>	<channel>		<typ>		
1	2	3	4	5	6	7	8	9	10	11	12	13	14		
01h	10h	01h	F0h	01h	B0h	0Ah	02h	23h	10h	00h	5Ch	02h	16h		
<value>				ETX	<cs>		EOT								
15	16	17	18	19	20	21	22								
B1h	FFh	0Dh	42h	03h	DEh	BCh	04h								

Table 17: UMB binary example, response from the sensor

The received snow depth in cm from channel 604 is 420DFFB1h = 35.4997 cm.

The conversion process follows the rules of IEEE-754 (float) conversion.

9.3.5 Status and Error Codes in Binary Protocol

If a measurement request delivers the <status> 00h, the sensor is working correctly. You can find a complete list of additional codes in the description of the UMB protocol.

Extract from list:

<status>	Description
00h (0d)	Command successful; no error; all o.k.
10h (16d)	Unknown command; not supported by this device
11h (17d)	Invalid parameter
24h (36d)	Invalid channel
28h (40d)	Device not ready; e.g. initialization / calibration running
50h (80d)	Measurement variable (+offset) is outside the set display range
51h (81d)	
52h (82d)	Measurement value (physical) is outside the measuring range (e.g. ADC over range)
53h (83d)	
54h (84d)	Error in measurement data or no valid data available
55h (85d)	Device / sensor is unable to execute valid measurement due to ambient conditions

9.3.6 CRC Calculation

CRC is calculated according to the following rules:

Norm: CRC-CCITT

Polynomial: $1021h = x^{16} + x^{12} + x^5 + 1$ (LSB first mode)

Start value: FFFFh

You can find further information in the description of a CRC calculation in UMB Protocol.

10 Communication in SDI-12 Mode

The communication in SDI-12 mode of the SHM31-UMB sensor is conform to the standard defined in 'SDI-12 A Serial-Digital Interface Standard for Microprocessor-Based Sensors Version 1.3 January 12, 2009'. Beginning with firmware version v16 SDI-12 version 1.4 is supported. The SHM31-UMB Sensor may be operated in bus mode together with other SDI-12 sensors, connected to one SDI master (logger).

10.1 Pin assignment for SDI-12

The SDI-12 mode uses the following connectors:

- SDI-12 signal (yellow)
- SDI-12 Ground: V_IN- / SDI-12_GND (white)

Please refer to table Pin assignment SHM 31 on page 19 in addition.

10.2 Preconditions for SDI-12 Operation

As the interface settings defined in the SDI-12 standard are significantly different from the UMB default settings, the related parameters have to be set properly by ConfigTool.NET (latest version!).

The protocol mode, parity and baud rate of the device have to be set correctly to be able to use "SDI-12". The ASCII 2.0- commands are listed in brackets:

Baud rate:	1200	(BAU=96)
RS485 parity:	7E1	(PRY=2)
Protocol mode:	SDI-12	(PRT=3)
Reset:		(RST)

After setting the parameters the sensor has to be restarted (Reset or power off/ on).



The measured values are transmitted in metric or US units. The selection of the unit system can be set using UMB or SDI-12 commands. An UMB-ASCII 2.0 command is not available.

10.3 Exit SDI-12 mode

When operating the device in SDI-12 mode it is not possible to access the device with the UMB Config Tool anymore, due to the different interface parameter settings.

It is still possible to use the RS232 interface and exit the SDI-12 mode using ASCII commands (change baud rate, Parity, protocol mode back to UMB mode).

Nevertheless to enable configuration access the interface is operated in standard UMB mode (19200 8N1) with ID 200 for the first 5 seconds(*) after reset / power on. It is mandatory to use the correct sensor ID 200. If a valid UMB telegram is received within this 5 sec, the device will stay in UMB mode for the configured time out (several minutes) so that the configuration can be modified.

- Connect the PC to SHM31-UMB Sensor through a RS-485 converter
- Start the ConfigTool.NET, check if the serial settings for UMB are correct:19200 Baud, 8N1. Start a SHM31-UMB device with the ID 200 and activate at least one channel. Start the measurement with 1sec polling rate.
- Reset the device (Power off / on)

- When measurement values are received the query process can be terminated, the interface is now open for configuration.



(*) Remark: The 5 seconds UMB communication are available from program start. Under consideration of the operating system start, where no communication is possible, the device will be ready for SDI12 requests after 7.0 – 7.5 seconds.

This timing only applies in case of cold start after power on or reset. Otherwise the device will respond within the time defined by the SDI12 standard.

10.4 Command Set

For details of the SDI-12 protocol please refer to the above mentioned standard document. Following commands are available for SHM31-UMB:



The examples in the following sections use italics to print the requests from the logger (OV!)

Command	Function
?!	Address search (Wildcard request, one device only on bus!)
a!	Request device active?
aI!	Request device identification
aAb!	Address change to b (0 ... 9, A ... Z, a ... z) <i>Restart is necessary to accept these changes on UMB or UMB ASCII Interface.</i>
aM!	Measurement basic minimal data set
aM1!	Measurement Angles
aM2!	Measurement Flags
aMC!	Measurement, basic minimal data set, transmit values with CRC
aMC1! ... aMC2!	Measurement (assignment of values as for aMn! commands), transmit values with CRC
aC!	Concurrent measurement, full basic data set
aC1! ... aC2!	Concurrent measurement, assignment of values as for aMn! commands, partly extended data sets
aCC!	Concurrent measurement, transmit values with CRC
aCC1! ... aCC2!	Concurrent measurement, assignment of values as for aMn! commands, partly extended data sets, transmit values with CRC
aD0!	Data request buffer 0
aD1!	Data request buffer 1
aR0!	Data request from continuous measurement, data set 0
aR1!	Data request from continuous measurement, data set 1
aRC0!	Data request from continuous measurement, data set 0 with CRC
aRC1!	Data request from continuous measurement, data set 1 with CRC
aV!	Command verification: Evaluate sensor status and heating temperatures, data request with aD0!, aD1!
aXUN<U/M>!	Change the unit system for SDI data
aXRES!	Device reset
	Firmware version v16 and newer (SDI-12 v1.4)
aIM! aIMC! aIMn! aIMCn! aIC! aICC! aICcn! aIVn!	Request the number of measurement values
aIM_00m! aIMC_00m! aIMn_00m! aIMCn_00m! aIC_00m! aICC_00m! aICcn_00m! aIRn_00m!	Request the measurement value parameters

Table 18: Command set for sensor with SDI-12-address 'a' (UMB-ID 37 (0x25))

Currently the composition of the minimal and the full basic data are identical. The same applies to the additional measurement commands (aM1!, aC1! etc.)

Due the applied measurement processes the SHM31-UMB will, different from other sensors described in the SDI-12 document, always measure continuously. This causes some special properties:

1. The device does not need a “Wakeup” and does not have a sleep mode.
2. Data requested with M- or C- commands are always available immediately. The device will always respond with a000n respectively a000nn. This means the device will not send any service request and will ignore measurement abort signals. The logger should request the data immediately.

10.5 Address Configuration

UMB Device-ID and SDI-12 Address are connected, but the different address ranges and the fact, that UMB ID's are integer numbers, while SDI-12 addresses are ASCII characters, have to be considered.

The SDI-12 address is built from the UMB device ID as follows:

1. UMB Device ID 1 (default) corresponds to SDI-12 Address '0' (SDI-12 default).
2. Changing the SDI12 address with the SDI12 setting command also modifies the UMB device ID accordingly.

UMB (dec)			SDI-12 (ASCII)		
1	to	10	'0'	to	'9'
11	to	36	'A'	to	'Z'
37	to	62	'a'	to	'z'

Table 19: SDI-12, valid address ranges

10.6 Data messages

In the interest of simplified evaluation the assignment of measurement values to data buffers '0' ... '9' has been defined uniform for all measurement commands. For this reason the responses to C-requests have been restricted to 35 characters, not using the 75 characters permitted for these requests. Currently buffers '0' and '1' are in use.

So far, the SHM31 firmware does not take advantage of the C-requests. C- and M-requests are handled in the same way.

If the measurement value is not available for some reason, e.g. sensor failure, this is indicated by a value of +9999999. or -9999999, or 99 / -99 for 8bit values. The logger can then evaluate the reason of failure by a aV! verification request. In addition, the “SHM31 error”, see table 20 and 21, is available for further analysis of errors. The following tables show the measurement values in the sequence they are arranged in the telegram (see example).

Depending on the configuration of the device the values will be transmitted in metric or US units.



The configured system of units is not indicated in the data messages. The logger may request this setting with the I-command and adjust the evaluation of the data messages accordingly.

10.6.1 Example: C and M-requests from SHM31-UMB

<i>0M! or 0C!</i>	
00008<CR><LF>	8 measurement values available for immediate retrieval
<i>0D0!</i>	
0+2346+0.1000+45.7-2.8<CR><LF> 0+2346+0.0+0.0+0.0<CR><LF>	Time stamp 2346sec, snow depth 0.1m, block temperature 45.7°C, ambient temperature -2.8°C in case of "MEN" (MeasurementEnd)
<i>0D1!</i>	
0+51.5+12+11.9+0<CR><LF> 0+0.0+0+0.0+67<CR><LF>	Laser temperature 51.5°C, normalised signal 12, tilt angle 11.9°, SHM31 error status 0 in case of "MEN" (MeasurementEnd)

10.6.2 Buffer Assignment Basic Data Set SHM31-UMB

Measurement Value	UMB-Channel	Min	Max	Unit
Puffer '0'				
Run time	4007	0	9999999	Sec
Snow depth (cur)	608	-16.0000	16.0000	m
Block temperature(cur)	100	-40,0	100,0	°C
Ambient temperature(cur)	108	-50,0	100,0	°C
Puffer '1'				
Laser temperature (cur)	120	-60,0	80,0	°C
Signal normalised (cur)	140	0	255	-
Tilt angle (cur)	160	-180,0	180,0	°
SHM31 error	4100	0	255	code

Table 20: SDI-12, Device configured for measurements in metric units

Example: Request Buffer '0': 0+2346+0.1000+45.7-2.8<CR><LF>

Time stamp 2346sec, snow depth 0.1m, block temperature 45.7°C, ambient temperature -2.8°C

Measurement Value	UMB-Channel	Min	Max	Unit
Puffer '0'				
Run time	4007	0	9999999	Sec
Snow depth (cur)	612	-626.9	629.9	inch
Block temperature(cur)	104	-40,0	212,0	°F
Ambient temperature(cur)	112	-58,0	212,0	°F
Puffer '1'				
Laser temperature (cur)	124	-76,0	176,0	°F
Signal normalised (cur)	140	0	255	-
Tilt angle (cur)	500	-180,0	180,0	°
SHM31 error	4100	0	255	code

Table 21: SDI-12, Device configured for measurement in US units

10.7 Additional Measurement Commands

The additional measurement commands

aM1! ... aM2!

aMC1! ... aMC2! (M-Command, data transmission with CRC)

aC1! ... aC2!

aCC1! ... aCC2! (C- Command, data transmission with CRC)

can be used to retrieve additional measurement values. Equally to the base data sets, in maximum 9 values can be requested with an additional M command, while an additional C request allows up to 20 values.

The buffer assignment as documented in the following paragraphs has consequently been structured in a way that the buffers D0 and D1 are used for each M command. If the sensor type has more values available the buffers D2 up to D4 will be occupied if required.

M1 / C1	Angles	M: 6 Values	C: 6 Values
M2 / C2	Flags	M: 7 Values	C: 7 Values

Measurand	UMB-Channel	Min	Max	Unit
Buffer '0'				
Run time	4007	0	9999999	s
Tilt angle (cur)	500	-180,0	180,0	°
X angle (cur)	504	-180,0	180,0	°
Buffer '1'				
Y angle (cur)	505	-180,0	180,0	°
Z angle (cur)	506	-180,0	180,0	°
Tilt angle reference (cur)	510	-180,0	180,0	°

Table 22: SDI-12, buffer assignment for the additional measurement commands M1 / C1: "Angles" in metric or US units

Measurand	UMB-Channel	Min	Max	Unit
Buffer '0'				
Run time	4007	0	9999999	s
snow depth (cur)	600	-16000.0	16000.0	mm
snow flag (cur)	700	0	1	code
fogging flag (cur)	710	0	1	code
signal normalized	800	0	255	-
Buffer '1'				
distance	650	-500.0	21000.0	mm
SHM31 error	4100	0	255	code

Table 23: SDI-12, buffer assignment for the additional measurement commands M2 / C2: "Flags" in metric units. The fogging flag is not calculated so far.

Measurand	UMB-Channel	Min	Max	Unit
Buffer '0'				
Run time	4007	0	9999999	s
snow depth (cur)	600	-629.9	629.9	in
snow flag (cur)	700	0	1	code
fogging flag (cur)	710	0	1	code
signal normalized	800	0	255	-
Buffer '1'				
distance	650	-19.7	826.8	in
SHM31 error	4100	0	255	code

Table 24: SDI-12, buffer assignment for the additional measurement commands M2 / C2: "Flags" in US units. The fogging flag is not calculated so far.

10.8 Message Device Identification

The device responds to the identification request with following message, example for SDI-12 device address '0':

`0I!`

`013Lufft.deSHM31xnnn`

x: Metric / US units (m = metric, u = US), nnn: Software version, i.e. for a SHM31-UMB configured for US units:

`0I!`

`013Lufft.deSHM31u010`

10.9 Message Verification

The command verification `aV!` is used to evaluate the status information of the device. The device responds with

`a0002<CR><LF>`

to the request, i.e. 2 values are available in the buffers.

The measurement values transmitted in buffer '0' contain the status information of the measurement channels.

The status data of the channels are assembled to form "fake measurement values", where each digit represents one status. See below for the coding of states.

The positions marked as "reserved" in the table are transmitted as '0'.

Buffer '0'	
Status group 1: +nnnn	Block temperature status, ambient temperature status, laser temperature status, tilt angle status
Status group 2: +nnnn	x/y/z angle status, snow depth status, calibration distance status, flags status

Sensor status codes:

Sensor status	Code
OK	0
Invalid_Channel	1
E2_CAL_ERROR E2_CRC_KAL_ERR FLASH_CRC_ERR FLASH_WRITE_ERR FLASH_FLOAT_ERR	2
MEAS_ERROR	3
MEAS_UNABLE	4
INIT_ERROR	5
VALUE_OVERFLOW CHANNEL_OVERRANGE	6
VALUE_UNDERFLOW CHANNEL_UNDERRANGE	7
BUSY	8
Other sensor status	9

Example (SHM31-UMB, SDI-12 Address '0', no error):*0V!*

00002<CR><LF>

0D0!

0+0000+0000<CR><LF>

Example (SHM31-UMB, SDI-12 Address '0', laser temperature measurement failure):*0V!*

00002<CR><LF>

0D0!

0+0030+0000<CR><LF>

10.10 Message Request Measurement Value Parameters (SDI-12 v1.4)

The message requests the measurement value identification of every single measurement value.

Request: `aI<Measurement Command>_0mm!`

Measurement Command: M, MC, M1...M9, MC1...MC9, C, CC, C1...C9, CC1...CC9, R1...R9, V

mm: Position of the measurement value

Response: `a, <Value Code>,<Unit>,<Value Type><CR><LF>`

Value Code	Measurement Value
TBK	Block temperature
TAM	Ambient temperature
TLA	Laser temperature
ATL	Tilt angle
ATX	X angle
ATY	Y angle
ATZ	Z angle
ARF	Reference angle
HSN	Snow height
DSTC	Calibrated distance
OSF	Snow flag
OFF	Fog flag
OSN	Normalised signal strength
ER	SHM31 error
DSTA	Device status
STA1	Sensor status 1
STA2	Sensor status 2
DRT	System time at request

Example:

`0IM_002!`

`0, HSN, mm, cur<CR><LF>`

10.11 Switching commands

Switching commands are implemented as manufacturer defined SDI12 “extended” commands and are used for the initiation of procedures.

Switching commands are composed from the prefix X as defined by the SDI12 standard, and an individual 3 character code. In general this code conforms with the related code of ASCII2 protocol.

If the command has been successfully accepted, the response is build by appending an „ok“ to the command code.

If the command can not be executed, e.g. due to other procedures still in operation, the response is built by appending a „busy“ to the command code.

If the 3 character command code is unknown the response will be

```
aX_noCmd<CR><LF>
```

Messages with wrong length or other format errors will be ignored.

10.11.1 Command Change of Unit System

The command is used to change the unit system used for the SDI12 data between metric and US units. It is implemented as manufacturer specific X command.

The parameter modification is directly applied and additionally transferred to the configuration memory of the device.

Command: `aXUN<U/M>!`

Response: `aXUN<U/M>ok<CR><LF>`

U: US units

M: metric units

Example: change to metric units, SDI-12 address '0'

```
0XUNM!
```

```
0XUNMok<CR><LF>
```

10.11.2 Command Device Reset

The command initiates a device reset.

Command: `aXRES!`

Response: `aXRESok<CR><LF>`

The response is followed by the device reset, i.e. the device will be offline for a few seconds.

Example: `0XRES!`

```
0XRESok<CR><LF>
```

10.11.3 Command Terminate Measurement

The command terminates the automatical snow depth measurement, e.g. for adjustment and calibration work.

Command: `aXMEN!`

Response: `aXMENok<CR><LF>`

If any procedure is active which prohibits the execution of the command, it will be rejected with

```
aXMENbusy<CR><LF>
```

10.11.4 Command Start Measurement

The command restarts the automatic snow depth measurement if it had been terminated for adjustment or calibration.

Command: *aXMST!*

Response: *aXMSTok<CR><LF>*

If any procedure is active which prohibits the execution of the command, it will be rejected with

aXMSTbusy<CR><LF>

10.11.5 Command Laser On

The command switches the laser permanently on, e.g. for adjustment of the measurement spot.

Command: *aXLON!*

Response: *aXLONok<CR><LF>*

If any procedure is active which prohibits the execution of the command, it will be rejected with

aXLONbusy<CR><LF>

10.11.6 Command Laser Off

The command switches the previously permanently activated laser off.

Command: *aXLOF!*

Response: *aXLOFok<CR><LF>*

If any procedure is active which prohibits the execution of the command, it will be rejected with

aXLOFbusy<CR><LF>

10.11.7 Command Calibrate Offset and Angle

The command initiates a measurement procedure for evaluation of distance and angle. The retrieved values are set as offset / reference height and angle correction value.

Command: *aXARV!*

Response: *aXARVok<CR><LF>*

If any procedure is active which prohibits the execution of the command, it will be rejected with

aXARVbusy<CR><LF>

10.11.8 Command Calibrate Offset

The command initiates a measurement procedure for evaluation of distance. The retrieved values are set as offset / reference height using the stored reference angle.

Command: *aXARH!*

Response: *aXARHok<CR><LF>*

If any procedure is active which prohibits the execution of the command, it will be rejected with

aXARHbusy<CR><LF>

10.11.9 Command Switch on defrost mode

The command switches on the heater defrost mode.

Command: *aXHDS!*

Response: aXHDSok<CR><LF>

10.11.10 **Command Switch off heater defrost mode**

The command switches off a running heater defrost mode

Command: aXHDE!

Response: aXHDEok<CR><LF>

10.12 **Parameter commands**

Parameter commands are implemented as SDI12 „extended“ command and are used for reading and setting of parameters.

Parameter commands are composed from the prefix X as defined by the SDI12 standard, an additional prefix “P” for parameter, and an individual 3 character code. In general this code conforms with the related code of ASCII2 protocol.

If the command is transmitted without appended setting value, the response will report the parameter value currently set.

The setting value shall be formatted according to SDI12 number conventions, i.e. always with leading sign “+” or “-“, and with a maximum of 7 digits plus decimal point. Independent of the data type of the parameter to be set, floating point as well as integer values will be accepted. If the data type of the parameter is integer, a floating point input will be rounded.

The transmitted setting value will be checked against the limits of the individual parameter. If the value is beyond the limits, the command is rejected with an appended “_invalid”, respectively “invalid-” (negative value not applicable).

If the command with the value to set has been successfully accepted, the response is composed from the command code with appended set value.

If the 3 character command code is unknown, the response is

aX_noCmd<CR><LF>

10.12.1 **Request of the Current Parameter Setting**

Command: aXPccc!

ccc: 3 character parameter code, see table below

Response: aXPccc<+/->nnn<CR><LF> in case of integer parameters, nnn: parameter

aXPccc <+/->fff.f<CR><LF> for floating point parameters

The number of digits nnn resp. fff is variable according to the parameter value

aX_noCmd<CR><LF> in case of unknown parameter code ccc

Example:

Request of the currently set laser measurement interval, SHM31-UMB with SDI12-ID ,0'

0XPLMI!

Response: 0XPLMI+5000<CR><LF>

10.12.2 Setting of Parameters

Command: `aXPccc<+/->nnn!`

`aXPccc<+/->fff.f!`

ccc: 3 character parameter code, see table below

nnn, fff.f: parameter value to be set, number of digits as required

Independent of the parameter's data type the value given in the command may be integer or floating point. The value will be rounded if necessary.

Response: `aXPccc<+/->nnn<CR><LF>` for integer parameters,
nnn: new parameter value

`aXPccc<+/->ff.f<CR><LF>` for floating point parameters,
ff.f new parameter value

The number of digits nnn resp. fff is variable according to the parameter value.

`aXP_invalid<CR><LF>` if the new parameter value is beyond the limits

`aXP_invalid-<CR><LF>` attempt to set a negative value for an unsigned parameter

`aX_noCmd<CR><LF>` in case of unknown parameter code ccc

Example: Setting of the laser measurement interval, SHM31-UMB with SDI12-ID ,0'

`0XPLMI+2500!` or `0XPLMI+2500.0!`

Response: `0XPLMI+2500<CR><LF>`

Code	Function	Data type	Value limits (factory settings in bold characters)	Units
ATI	Measurement interval	uint16	0 ... 60	s
HWM	Window heating mode	uint8	0 / 1	-
HBM	Block heating mode	uint8	0 / 1	-
HEP	Enable external switching of heating	uint8	0 / 1	-
HDM	Heating defrost after power on	uint8	0 / 1	-
AOF	Distance offset	float	0.0 ... 16000.0	mm
AAN	Correction angle	float	0.0 ... 180.0	°
UAA	Use accelerometer angle	uint8	0 / 1	-
MSA	Time constant for suppression of short term depth changes	uint16	0 ... 600 ... 65535	s
MSD	Maximum accepted change of snow depth per interval	float	-20000.0 ... 20.0 ... 20000.0	mm
LMM	Laser measure mode	uint8	0 ... 7	-
LMI	Laser measurement interval	uint32	1000 ... 10000 ... 60000	ms

Table 25: SDI-12, Parameter settings available in SDI-12 mode.

11 Communication in Modbus Mode

For simpler integration of the SHM31-UMB into PLC environments communication using the Modbus protocol has been implemented.

The measurement values are mapped to Modbus Input Registers. The range of values available is basically the same as for the UMB protocols, including different unit systems.

In the interest of simple and safe integration the use of register pairs for floating point values or 32bit integers, which is not part of the Modbus standard as such, has not been applied. All measurement values are mapped to 16bit integers, using suitable scaling factors.

For the following description a basic understanding of Modbus communication is assumed. Details may be found in the related standard documents Modbus_Application_Protocol and Modbus_Over_Serial_Line, available online at www.modbus.org/specs.php .

11.1 Modbus Connection and Communication Parameters

The SHM31-UMB is connected to a Modbus logger or a Modbus network through the RS485 interface.

The SHM31-UMB can be configured for MODBUS-RTU or MODBUS-ASCII .

The basic configuration has to be done by ConfigTool.NET.

Modbus Operating Modes: MODBUS-RTU, MODBUS-ASCII

Baud Rate: 19200 (9600, 4800 und kleiner)

Interface Setting 8E1, 8N1, 8N2

Note: Modbus communication has been tested for a poll rate of 1sec. The proper function of the SHM31-UMB with faster Modbus poll rates has not been tested.

11.2 Addressing

The Modbus device address is derived from the UMB device ID (see chapter 7.3).

A device with UMB device ID 1 also has the Modbus address 1, etc.

The valid address range of Modbus from 1 to 247 is smaller than that of the UMB device IDs. If a UMB device ID > 247 has been selected, the Modbus address will be set to 247.

11.3 Modbus Functions

Modbus functions of conformance class 0 and 1 have been implemented as far as they are applicable for the SHM31-UMB, i.e. all function operating on register level.

Modbus Function	Conformance Class	Verwendung
	Conformance Class 0	
0x03	Read Holding Registers	Selected configuration settings
0x16	Write Multiple Registers	Selected configuration settings
	Conformance Class 1	
0x04	Read Input Registers	Measurement values and status information
0x06	Write Single Register	Selected configuration settings
0x07	Read Exception Status	Currently not used
	Diagnostics	
0x11	Report Slave ID	(responds also to broadcast address)

11.3.1 Functions 0x03 Read Holding Registers, 0x06 Write Single Register, 0x16 Write Multiple Registers

The Holding Register are used to make a selected set of adjustable parameters as well as actions available for Modbus access.

Similar to the measurement values the parameters are mapped to 16bit integer register values, if necessary using a scaling factor.

Registers representing parameters will return the currently active value of the parameter

When writing into a parameter register, the new value will be assigned to the permanent storage, but will be active only after a device reset. I.e. reading the register will return the new value not before a device reset. The value to be written is checked for acceptability. If the configured limits are exceeded, the sensor will respond with a Modbus exception "Illegal Data Value" and not execute the instruction.

Actions will be executed when a value of 0x3247 (hex) resp. 12871 (decimal) is written into the related register. If the action can not be executed the sensor will respond with a Modbus exception "Illegal Data Value".

Action register will always deliver 0 on reading.

Action Registers

Reg. Nr.	Reg. Adr.	Function	Description
1	0	Sensor Reset	Initiated a sensor reset. During the reset process Modbus communication is interrupted for a few seconds
2	1	Measurement Start	Starts normal measurement operation *)
3	2	Measurement End	Terminates normal measurement operation *)
4	3	Laser On	Laser permanently on (e.g. for sensor alignment) *)
5	4	Laser Off	Turn laser off after "Laser On" *)
6	5	Automatic Calibration	Automatic Calibration of reference angle and height *)
7	6	Automatic Height Calibration	Automatic Calibration of reference height *)
8	7	Start defrosting	Start defrosting process
9	8	End defrosting	Terminate defrosting process

*) Action can only be executed if the current operation status permits this. If not, the response to the write operation will be a Modbus exception „ILLEGAL_DATA_VALUE“. This also applies to the case when the requested operation is already active.

Parameter Registers

Reg. Nr.	Reg. Adr.	Function	Values	Factor
10	9	Operating mode block heating	0 = OFF 1 = automatic 2 = start single defrost operation 3 = terminate defrost operation	1
11	10	Operating mode window heating	0 = OFF 1 = automatic 2 = start single defrost operation 3 = terminate defrost operation	1
12	11	Enable external heating control	0 = ignore ext. control pin 1 = enable ext. control pin	1
13	12	Automatic defrosting after power on	0 = OFF 1 = ON	1
14	13	Reference height	Reference height above measurement point in mm Range: -16000 ... +16000	1
15	14	Sensor tilt angle	Reference angle in ° Range -180 ... +180	1
16	15	Use accelerometer angle	Use current angle from accelerometer for calculation 0 = use stored reference angle 1 = use current accelerometer angle	1
17	16	Acceptance time for snow height change	Time to accept snow height change exceeding the configured max. snow height	1

			difference [sec] Range: 0 ... 65535	
18	17	Maximum snow height difference	Maximum accepted snow height difference between two measurements [mm] Range: -20000 ... +20000	1
19	18	Laser operating mode	Not yet implemented Range: 0	1
20	19	Laser measurement interval	Laser measurement interval [msec] Range 1000 ... 60000 Values less than 5000ms are not recommended!	1

11.3.2 Function 0x04 Read Input Registers

Input registers hold the SHM31-UMB measurement values and related status informations.

The measurement values are mapped by scaling to the 16 bit registers (0 ... max. 65530 for unsigned values, -32762 ... 32762 for signed values).

Values 65535 (0xffff) resp. 32767 (0x7fff) are used for indication of values with status not OK. A more detailed specification of the error may be retrieved from the status registers (see below).

The assignment of measurement values to register addresses (0 ... 119) has been designed in a way to allow the user to access the usually required data with the least number of register block requests (best case only one request).

Following blocks have been assigned:

- Status informations
- Standard data set, metric units
- Standard data set, imperial units
- Distances
- Temperatures, metric units
- Temperatures, imperial units
- Angles
- Logic and normalized values
- Service channels

The following table lists the input registers with scaling factors and the information, if the received register value is to be interpreted a signed (S) or unsigned (U).

A scaling factor of 10 means, that the register value shall be divided by 10 to get a value with a resolution of one decimal.

Reg. No.	Reg. Adr.	Measurement value	Description	Factor	Signed / unsigned
			Status Information		
1	0	Device Identification	High Byte: Device subtype Low Byte: Software version	1	U
2	1	Device status	lower 16bit of the device status	1	U
3	2	Device-Status	upper 16bit of the device status	1	U
4	3	Status block heating	0 = Heating off 1 = Heating on	1	U
5	4	Status window heating	0 = Heating off 1 = Heating on	1	U
6	5	Status block temperature	UMB status code (see chapter 9.3.5)	1	U
7	6	Status ambient temperature	UMB status code (see chapter 9.3.5)	1	U
8	7	Status laser temperature	UMB status code (see chapter 9.3.5)	1	U
9	8	Status tilt angle	UMB status code (see chapter 9.3.5)	1	U

10	9	Status snow height	UMB status code (see chapter 9.3.5)	1	U
11	10	Status distance	UMB status code (see chapter 9.3.5)	1	U
12	11	Status normalized signal	UMB status code (see chapter 9.3.5)	1	U
13	12	reserved			
14	13	reserved			
15	14	SHM31 error code	(see chapter 13.3.3)	1	U
16	15	SHM31 error code (cur)	(see chapter 13.3.3)	1	U
17	16	Accumulated operating time	lower 16bit of attended time [sec]	1	U
18	17	Accumulated operating time	upper 16bit of attended time [sec]	1	U
19	18	System time	lower 16bit of system time [sec]	1	U
20	19	System time	upper 16bit of system time [sec]	1	U
			Standard data set metric		
21	20	Snow height mm (cur)	Range: -16000 ... 16000	1	S
22	21	Block temperature °C (cur)	Range: -400 ... 1000 → -40.0 ... 100.0	10	S
23	22	Ambient temperature °C (cur)	Range: -500 ... 1000 → -50.0 ... 100.0	10	S
24	23	Laser temperature °C (cur)	Range: -600 ... 800 → -60.0 ... 80.0	10	S
25	24	Normalized signal	Range: 0 ... 255	1	U
26	25	Tilt angle ° (cur)	Range: -1800 ... 1800 → -180.0 ... 180.0	10	S
27	26	SHM31 error code	Range: 0 ... 255 (see chapter 13.3.3)	1	U
28	27	reserved			
29	28	reserved			
30	29	reserved			
			Standard data set imperial		
31	30	Snow height in (cur)	Range: -12598 ... 12598 → -629.9 ... 629.9	20	S
32	31	Block temperature °F (cur)	Range: -400 ... 2120 → -40.0 ... 212.0	10	S
33	32	Ambient temperature °F (cur)	Range: -580 ... 2120 → -58.0 ... 212.0	10	S
34	33	Laser temperature °F (cur)	Range: -760 ... 1760 → -76.0 ... 176.0	10	S
35	34	Normalized signal	Range: 0 ... 255	1	U
36	35	Tilt angle ° (cur)	Range: -1800 ... 1800 → -180.0 ... 180.0	10	S
37	36	SHM31 Error-Code	Range: 0 ... 255 (see chapter 13.3.3)	1	U
38	37	reserved			
39	38	reserved			
40	39	reserved			
			Distances		
41	40	Snow height mm (cur)	Range: -16000 ... 16000	1	S
42	41	Snow height mm (min)	Range: -16000 ... 16000	1	S
43	42	Snow height mm (max)	Range: -16000 ... 16000	1	S
44	43	Snow height mm (avg)	Range: -16000 ... 16000	1	S
45	44	Distance calibrated mm (cur)	Range: -500 ... 21000	1	S
46	45	Distance raw mm (cur)	Range: -500 ... 21000	1	S
47	46	Snow height in (cur)	Range: -12598 ... 12598 → -629.9 ... 629.9	20	S
48	47	Snow height in (min)	Range: -12598 ... 12598 → -629.9 ... 629.9	20	S
49	48	Snow height in (max)	Range: -12598 ... 12598 → -629.9 ... 629.9	20	S
50	49	Snow height in (avg)	Range: -12598 ... 12598 → -629.9 ... 629.9	20	S
51	50	Distance calibrated in (cur)	Range: -394 ... 16536 → -19.7 ... 826.8	20	S

52	51	Distance raw in (cur)	Range: -394 ... 16536 → -19.7 ... 826.8	20	S
53	52	Reference height mm	Range: 0 ... 16000	1	S
54	53	Snow height mm, high resolution	Range (mit Offset 1000.0): 0 ... 64000 → -1000.0 ... 5400.0	10	U
55	54	reserved			
			Temperatures metric		
56	55	Block temperature °C (cur)	Range: -400 ... 1000 → -40.0 ... 100.0	10	S
57	56	Block temperature °C (min)	Range: -400 ... 1000 → -40.0 ... 100.0	10	S
58	57	Block temperature °C (max)	Range: -400 ... 1000 → -40.0 ... 100.0	10	S
59	58	Block temperature °C (avg)	Range: -400 ... 1000 → -40.0 ... 100.0	10	S
60	59	Ambient temperature °C (cur)	Range: -500 ... 1000 → -50.0 ... 100.0	10	S
61	60	Ambient temperature °C (min)	Range: -500 ... 1000 → -50.0 ... 100.0	10	S
62	61	Ambient temperature °C (max)	Range: -500 ... 1000 → -50.0 ... 100.0	10	S
63	62	Ambient temperature °C (avg)	Range: -500 ... 1000 → -50.0 ... 100.0	10	S
64	63	Laser temperature °C (cur)	Range: -600 ... 800 → -60.0 ... 80.0	10	S
65	64	Laser temperature °C (min)	Range: -600 ... 800 → -60.0 ... 80.0	10	S
66	65	Laser temperature °C (max)	Range: -600 ... 800 → -60.0 ... 80.0	10	S
67	66	Laser temperature °C (avg)	Range: -600 ... 800 → -60.0 ... 80.0	10	S
68	67	reserved			
69	68	reserved			
70	69	reserved			
			Temperatures imperial		
71	70	Block temperature °F (cur)	Range: -400 ... 2120 → -40.0 ... 212.0	10	S
72	71	Block temperature °F (min)	Range: -400 ... 2120 → -40.0 ... 212.0	10	S
73	72	Block temperature °F (max)	Range: -400 ... 2120 → -40.0 ... 212.0	10	S
74	73	Block temperature °F (avg)	Range: -400 ... 2120 → -40.0 ... 212.0	10	S
75	74	Ambient temperature °F (cur)	Range: -580 ... 2120 → -58.0 ... 212.0	10	S
76	75	Ambient temperature °F (min)	Range: -580 ... 2120 → -58.0 ... 212.0	10	S
77	76	Ambient temperature °F (max)	Range: -580 ... 2120 → -58.0 ... 212.0	10	S
78	77	Ambient temperature °F (avg)	Range: -580 ... 2120 → -58.0 ... 212.0	10	S
79	78	Laser temperature °F (cur)	Range: -760 ... 1760 → -76.0 ... 176.0	10	S
80	79	Laser temperature °F (min)	Range: -760 ... 1760 → -76.0 ... 176.0	10	S
81	80	Laser temperature °F (max)	Range: -760 ... 1760 → -76.0 ... 176.0	10	S
82	81	Laser temperature °F (avg)	Range: -760 ... 1760 → -76.0 ... 176.0	10	S
83	82	reserved			
84	83	reserved			
85	84	reserved			
			Angles		
86	85	Tilt angle ° (cur)	Range: -1800 ... 1800 → -180.0 ... 180.0	10	S
87	86	Tilt angle ° (min)	Range: -1800 ... 1800 → -180.0 ... 180.0	10	S
88	87	Tilt angle ° (max)	Range: -1800 ... 1800 → -180.0 ... 180.0	10	S
89	88	Tilt angle ° (avg)	Range:	10	S

			-1800 ... 1800 → -180.0 ... 180.0		
90	89	X angle ° (cur)	Range: -1800 ... 1800 → -180.0 ... 180.0	10	S
91	90	Y angle ° (cur)	Range: -1800 ... 1800 → -180.0 ... 180.0	10	S
92	91	Z angle ° (cur)	Range: -1800 ... 1800 → -180.0 ... 180.0	10	S
93	92	Tilt angle ° Reference	Range: -1800 ... 1800 → -180.0 ... 180.0	10	S
94	93	reserved			
95	94	reserved			
			Logic and normalized values		
96	95	Snow flag	0: no snow 1: snow		
97	96	Fog flag	0: no fog 1: fog		
98	97	Normalized signal (cur)	Range: 0 ... 255	1	U
99	98	Normalized signal (min)	Range: 0 ... 255	1	U
100	99	Normalized signal (max)	Range: 0 ... 255	1	U
101	100	Normalized signal (avg)	Range: 0 ... 255	1	U
102	101	reserved			
103	102	reserved			
104	103	reserved			
105	104	reserved			
			Service channels		
106	105	Status block heating	0 = Heating off 1 = Heating on	1	U
107	106	Internal NTC temperature °C	Range: -400 ... 1000 → -40,0 ... 100,0	10	S
108	107	reserved			
109	108	Block heating defrost time sec	Range: 0 ... 65535	1	U
110	109	Status window heating	0 = Heating off 1 = Heating on	1	U
111	110	External NTC temperature °C	Range: -500 ... 1000 → -50,0 ... 100,0	10	S
112	111	reserved			
113	112	Window heating defrost time sec	Range: 0 ... 65535	1	U
114	113	Laser gain code	Range: 0 ... 255	1	U
115	114	Laser signal intensity (µV)		0,1	S
116	115	Laser distance mm	Range: 0 ... 32000	1	U
117	116	Laser temperature °C	Range: -600 ... 8000 → -60,0 ... 80,0	10	S
118	117	Operating voltage V	Range: -400 ... 400 → -40.0 ... 40.0	10	S
119	118	reserved			
120	119	reserved			

12 Check the signal quality

(Instructions for using the Target Set 8365.KWK-SET)

The signal quality of the sensor can be checked at the measuring location with well defined target panels. These panels consists of the following DIN A4 high-quality photo cards:

- White card 8365.KWK-WS with cover, 85 % reflectance
- Black card 8365.KWK-SW with cover, 6 % reflectance

The cards can be carefully cleaned with water and some dishwashing detergent. Do not use harsh detergents or solvents. Avoid scratches for a long lifetime!

Remove residual moisture or residues of cleaning agents with a lint-free cotton cloth.

12.1 Application

The target panels enable the users of our snow depth sensors to verify the signal strength of the respective sensors. In this case, the signal strength can be tested with the target boards as a function of distance and different reflectivity.

The curves in 30 show the different signal strengths, determined for different target boards, e.g. the white board 8365.KWK-WS and the black board 8365.KWK-SW.

The reflectivity of the white and black target panels corresponds to the bright and dark targets, which are stored in the sensor for different distances during factory normalization.

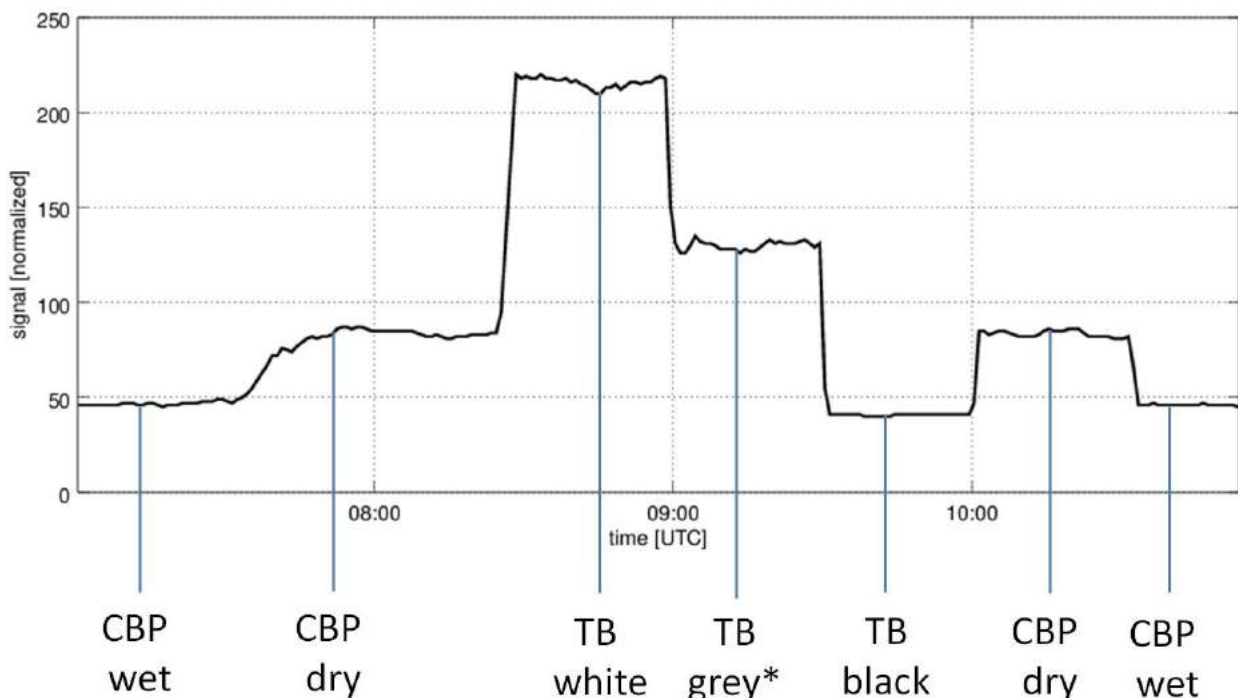

Figure 30: Variation of the signal strength using the different target boards. CBP: concrete base plate, ZT: target board (*grey: 50% reflection board that is not part of set).

A basic measurement setup is shown in 31. It is important to place the target panels horizontally onto ground to get the angle corrected signal strength value from the sensor. A good result can only be achieved if the sensor was set-up correctly in advance, see section Start-up procedure.



Figure 31: Check of the signal quality using the white board 8365.KWK-WS

The measurements shown in 30 were obtained with the measurement setup in 31.

The range of signal strength (signal normalized) is between 0 and 255. The sensors are set to achieve a value of 50 for the blackboard and 200 for the whiteboard. The exact values for the adjustment are documented in the factory certificate.

In the present measurement example, the target board results were compared with the measured values on the concrete panel in the dry and moist state. Also a card with a 50% reflection was used.

The tolerances in the signal strength of the SHM31 sensors are in the order of 20%. This allows a rough distinction between a dark background (grass, asphalt) and a snow cover. The threshold value is stored in the sensor at 130 as the default value and can be adjusted if necessary. Above the threshold, the "snow flag" = 1 is set. Below the threshold it is zero.

If the user assumes that the sensor is no longer adequately measuring due to ageing or other reasons, the procedure described here provides a test option that is easy to carry out.

13 Service, maintenance and technical support

13.1 Firmware update

We recommend to keep your SHM31 sensor up-to-date and frequently check the availability of new firmware. The firmware can be downloaded on www.lufft.com/resources/.

You can update the firmware easily using the UMB ConfigTool.NET software. To do so, please follow the steps below:

1. Download the sensor firmware
2. launch ConfigTool.NET and open the “workspace details” menu

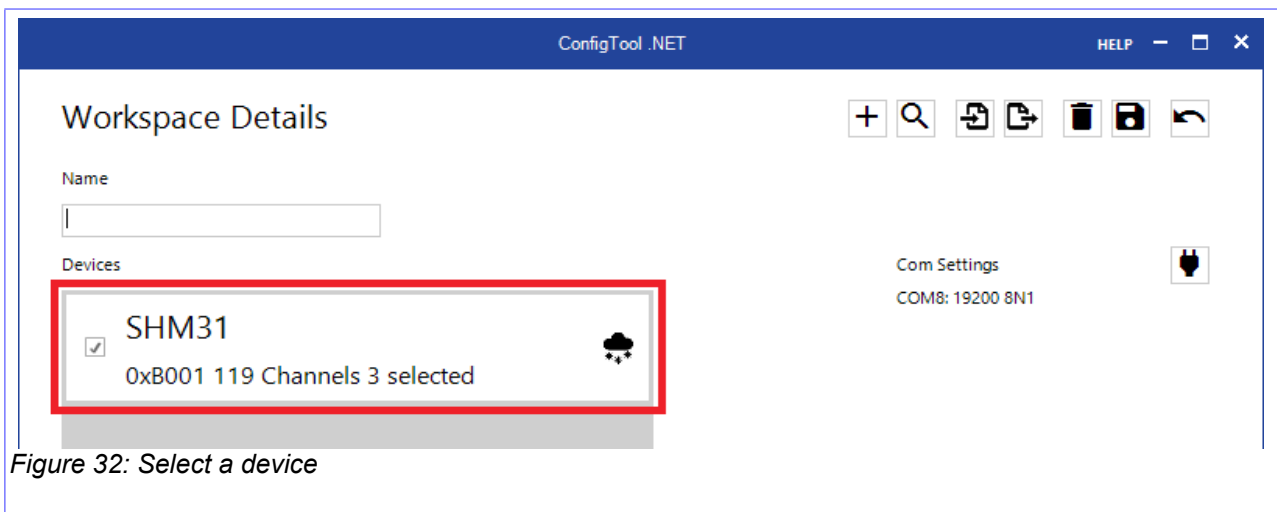

3. select the SHM31 from the list in the menu (*figure 32*)
4. click on the update-button and select the previously downloaded firmware file in the “firmware update” window (*figure 33*)

Note: The firmware update requires a reboot of the sensor. If “Reboot” remains unselected the sensor will stay operational using the old firmware version.

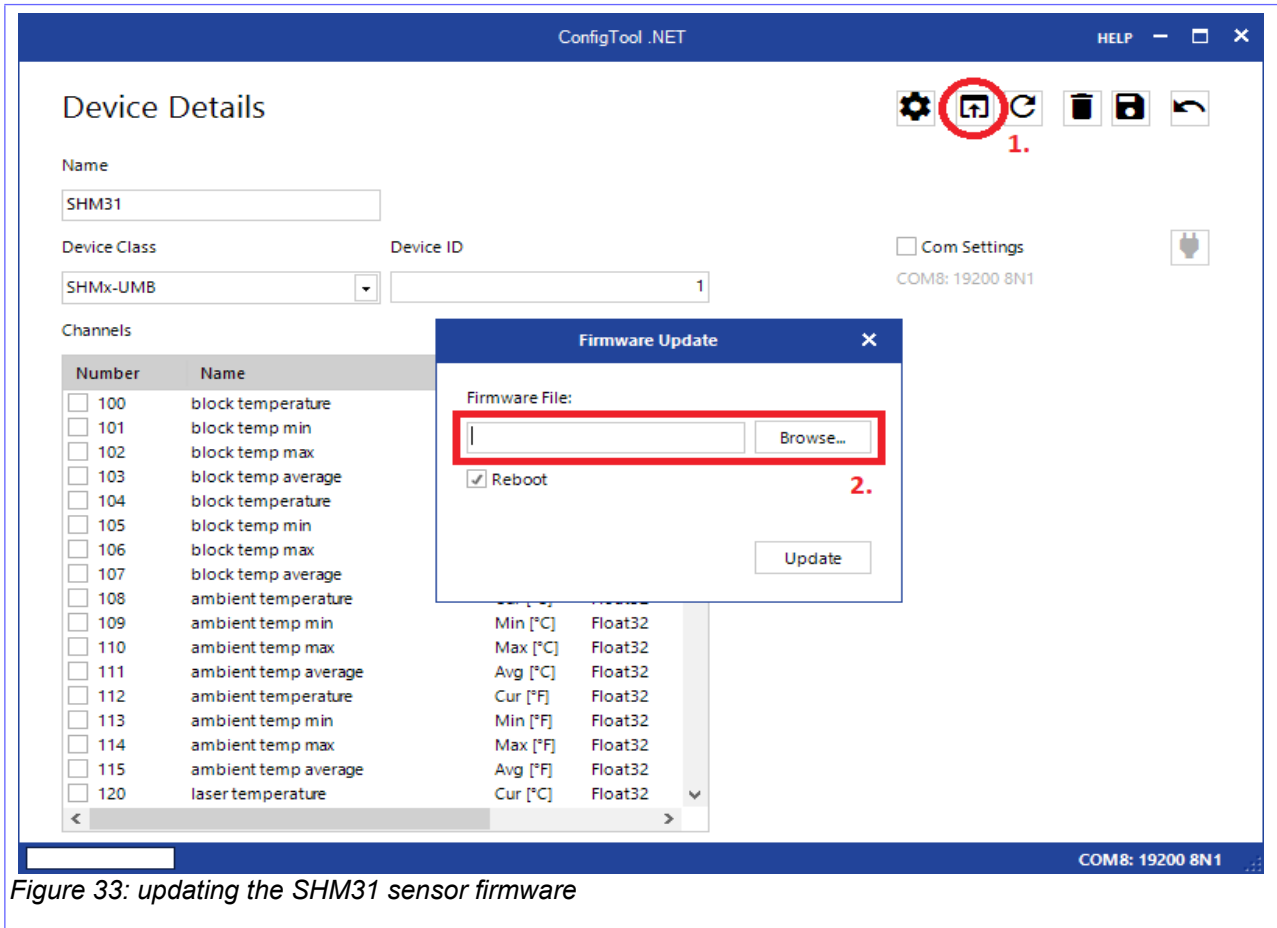

Figure 33: updating the SHM31 sensor firmware

13.2 Maintenance



NOTE: Be sure to turn off the power supply of the sensor during maintenance / cleaning!

Cleaning of the front screen

If the glass pane of the sender / receiver is polluted, please clean it with a moist, well wrung tissue. Afterwards dry the glass with a dry lint-free cotton tissue.

Please remove dust and dirt from the housing, too.

Please do not use solvents like cleaning solvent, thinner, alcohol, kitchen cleaner etc. to clean the sensor as these can damage the housing and the optical parts of the sensor.

In case you use a chemical cleaning tissue, please follow the instructions accordingly.

13.3 Malfunction

13.3.1 Possible error indications at the snow depth sensor:

Description of error	Cause – troubleshooting
The device cannot be contacted or gives no answers	<ul style="list-style-type: none"> • Check the power supply • Check the cable • Check the interfaces; if necessary please use the RS232 interface for checking if the error only exist at RS485 interface.
The device does not provide plausible values	<ul style="list-style-type: none"> • Check that the mounting instructions have been followed when the sensor was installed • Check the reference values, see chapter “Checking of the signal quality”

13.3.2 Possible disturbing influences, which can affect the proper functioning

- Contamination of the sending / receiving window of the snow depth sensor
- Highly reflecting surface / ice surface so that the majority of the laser beam is reflected. In the case of vertical mounting, it can also happen that the laser beam is reflected back into the laser, which can also lead to a fault message.
- Ambiguous target, e.g. by water on the ground

13.3.3 Error codes

In the UMB channels 4100 and 4101, the status codes for the snow depth sensor SHM 31 can be retrieved. In addition the status is part of the UMB-ASCII 2.0 data telegram.

The error codes are structured similarly to the SHM 30 error codes and have been extended specifically.

Error codes	Description
E15	Laser: signal too weak or distance too short
E16	Laser: signal too strong (mirror reflection effect)
E17	Laser: Background light level too strong.
E18	Laser: measurement disturbed (precipitation, movement of sensor or target while measuring, ...)
E19	Laser switched off due to too many timeouts
E20	Laser communication error
E21	Laser communication error (interface)
E22	Laser communication error (response not valid)
E23	Laser temperature below -15 °C
E24	Laser temperature above +50 °C
E31	Hardware error, EEPROM checksum incorrect, > sensors module must be returned to Lufft
E32	Laser hardware error, EEPROM checksum incorrect, > sensors module must be returned to Lufft

Error codes	Description
E51	Laser: detector voltage off (stray light or hardware error)
E52	Laser current too high, module defect > sensor return to Lufft
E53	Algorithm (division by 0)
E54	Laser hardware error > sensors module must be returned to Lufft
E55	Hardware error > sensors module must be returned to Lufft
E61	Hardware error interface board > sensors module must be returned to Lufft
E62	Parity error, interface communication (SIO)
E63	SIO overflow, timing for output signals in application software
E64	Framing error SIO, serial interface parameter is not set correctly to 8N1
E65	Evaluation routine: Partial measurements in the calculation interval were ignored because they exceeded the maximum permitted change in snow height.
E66	Evaluation routine: The last valid snow depth was output since all measurements in the calculation interval had exceeded the maximum permitted snow height change.
E67	Measurement were stopped by „MEN“ command
E68	There is no valid telegram, e.g. after starting the measurement with 'MST'
E70	Evaluation routine: could not read settings
E71	Evaluation routine: has not received any data from the laser
E72	Evaluation routine: has not received any temperature data from the laser
E73	Evaluation routine: has not received any inner temperature data
E74	Evaluation routine: has not received any window temperature data
E75	Evaluation routine: has not received any distance data from the laser
E76	Evaluation routine: accelerometer data vector length is incorrect
E77	Evaluation routine: use reference angle, cause current angle is incorrect
E78	Evaluation routine: signal calibration: signal_high <= signal_low
E79	Evaluation routine: signal calibration: signal too small
E80	Evaluation routine: signal calibration: signal too large
E81	Evaluation routine: signal calibration: no angle correction, because angle is > 90 degree
E82	Evaluation routine: : channel_average_count too large
E83	Evaluation routine: cannot initialize ring buffer for avg/min/max channels

Table 26: Error codes

13.4 UMB status codes

The UMB status codes are also used for error and status analysis. A description can be found in the general UMB description.

13.5 Within the EU

The device must be disposed in accordance with the European Directives 2002/96 / EC and 2003/108 / EC (Waste Electrical and Electronic Equipment). Old devices should not be disposed

in the household waste! For environmentally friendly recycling and disposal of your old equipment, please contact a certified disposal company for electronic waste.

13.6 Outside the EU

Please check the regulations applicable in the respective country for proper disposal of electronic waste equipment.

13.7 Service / Repair

Please let a defect device only be checked and if necessary repaired by the manufacturer. Do not open the inside of the unit, or try to repair it by yourself.

In case of requirements concerning repair, please contact your local sales representative or:

G. Lufft Mess- und Regeltechnik GmbH

P.O. Box 4252
70719 Fellbach
Germany

Tel: +49 711 51822-0
Hotline: +49 711 51822-52
Fax: +49 711 51822-41
E-Mail: info@lufft.com

13.8 Technical Support

With technical question please email our Hotline at

Email: service@lufft.com

**G. Lufft Mess- und
Regeltechnik GmbH**

Lufft Germany

Fellbach

Gutenbergstraße 20
70736 Fellbach
Postanschrift:
Postfach 4252
70719 Fellbach
Tel.: +49 (0)711 51822 - 0
Fax: +49 (0)711 51822 - 41
info@lufft.de
www.lufft.com

Berlin

Carl-Scheele-Straße 16
12489 Berlin
Tel.: +49 (0)711 51822 - 831
Fax: +49 (0)711 51822 - 944
info@lufft.de
www.lufft.com

a passion for precision · passion pour la précision · pasión por la precisión · passione per la precisione · a passion

Lufft Americas

Lufft USA, Inc.

1110 Eugenia Pl. Unit B
Carpinteria, CA 93013, USA
Tel.: +1 919 556 0818
Fax: +1 805 845 4275
sales@lufftusainc.com
www.lufft.com

Lufft China

Lufft (Shanghai)

Measurement & Control
Technology Co., Ltd.Te
Room 507 & 509, Building No.3,
Shanghai Yinshi Science and
Business Park,
No. 2568 Gudai Road,
Minhang District,
201199 Shanghai, China
Tel.: +86 21 5437 0890
Fax: +86 21 5437 0910
china@lufft.com
www.lufft.cn

