



Manual Data Logger met[LOG]

Id-No. 00.95800.010000
(incl. SD card)

LAMBRECHT meteo

AN **aem** BRAND

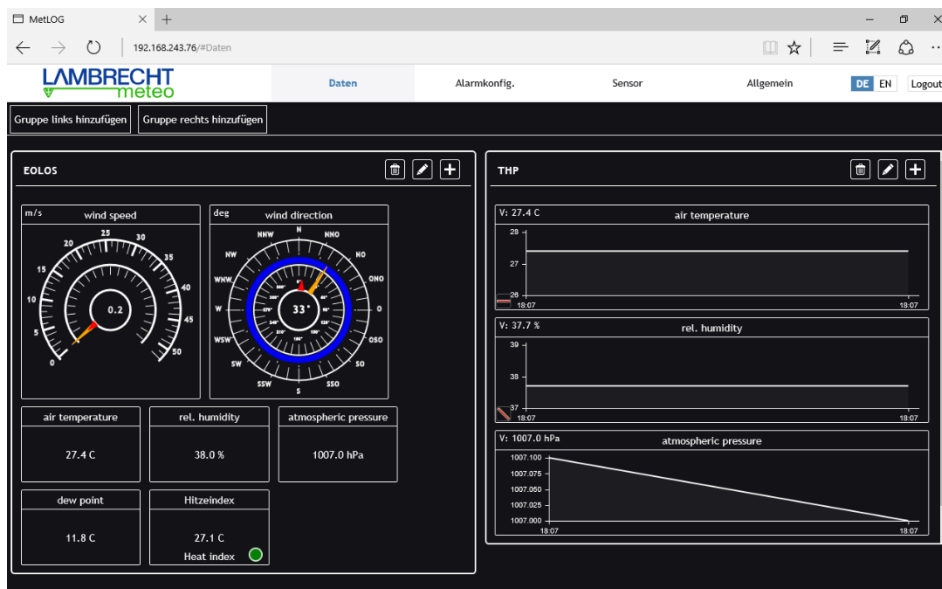
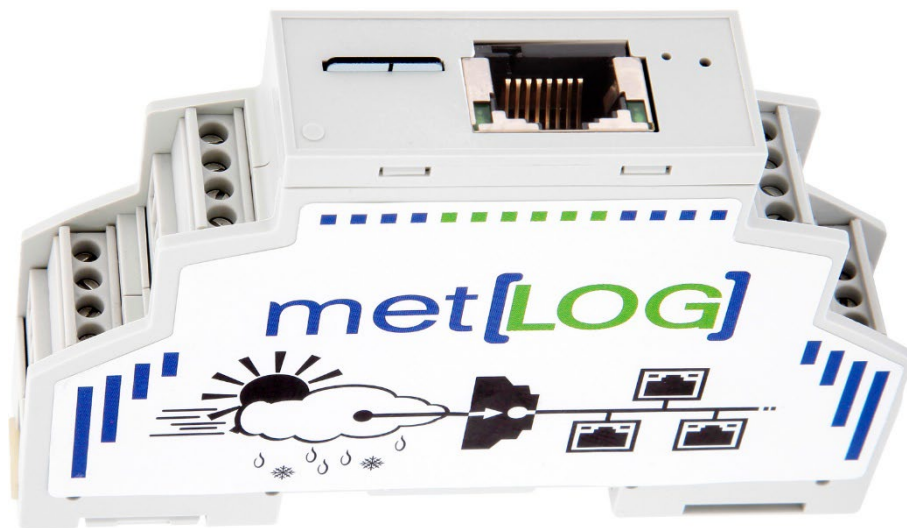

The met[LOG] is a small serial 3.4 channel data logger with 3 serial interfaces, 4 analogue/digital interfaces and connection to LAN (Ethernet). The met[LOG] has an integrated web server, which allows for calling and displaying data directly via a browser. Warnings and alarms can be called via the 4 digital outputs.

Fast operation with serial LAMBRECHT sensors is activated by met[LOG]'s auto-configuration mode.

Features - Overview

- Connection of serial LAMBRECHT sensors
- Parallel connection of up to 3 talker sensors (one per COM port)
- Connection of 4 analogue/digital sensors
 - Temperature measurement via NTC temperature sensors
 - Direct connection of sensors with Open Collector or Relay output
 - Connection of sensors with voltage output
- Connection of LAMBRECHT precipitation sensors with impulse output
 - Integrated intensity-dependent linearisation of the precipitation amount
- Data saving via SD card
- Vectorial link of wind direction and speed selectable
- Transfer of data to MeteoWare CS3
- Visualisation of real values and progressions via integrated web page
 - Gauges for wind direction and speed
 - Development display for temperature, humidity, pressure, radiation, precipitation amount
 - Trend display for temperature, humidity, pressure
 - Status display for sunshine and rain
 - Calculation and display of wind peak and maximum gust
 - Calculation and display of heat index/humidex or wind chill
 - Calculation of dew point
 - Calculation of absolute air humidity
 - Altitude correction of air pressure (QFE)
 - Calculation of air pressure at sea level (QNH or QFF)
 - Calculation of sunshine duration per day
 - Calculation of precipitation duration per day
- Alarms via 4 digital outputs
 - Warnings depending on wind direction possible
 - 8 warning channels that can be connected logical (AND/OR) with each other
 - Configuration of alarms via integrated web page
 - Hysteresis function or window function
 - Logic test of configured alarms
 - Function test of digital outputs via button press (software)
- Configuration of met[LOG] via integrated web page
 - Configuration of data savings
 - Configuration of visualisation
 - Automatic settings of time and date at connection to time server
- Auto-configuration mode at connection of serial LAMBRECHT sensors
- Different languages selectable (German / English)
- Connection of rain[e]
 - rain[e] talker protocol
 - rain[e] SDI-12 to RS485
- Simple firmware update via SD card

Connectable sensors

Following LAMBRECHT sensors can be connected with the met[LOG].

Serial sensors

Via RS422 Talker (RS485) - NMEA:

- EOLOS IND/MET
- ARCO
- WENTO IND/MET
- THP

Via RS485 – ASCII protocol, Talker or SDI-12:

- rain[e]

Additionally, the following LAMBRECHT sensors with voltage, frequency, impulse, and status output can be connected. The voltage output can be configured from 0...10 V and displayed with 16Bit (approx. 0.15 V).

Analogue sensors

Via Analogue/Digital input:

- Industry 0...10 V
- PRO-WEA 0...10 V
- Professional 0...10 V
- ORA
- Basic
- 15189
- Global radiation sensor 16106 with 0...10 V
- 8093.11 (T/H-Sensor) with 2x 0...1 V
- 8121 (Pressure) 0...2 V
- NTC (optional)
- Sunshine duration sensors

Table of Contents

| | | |
|-------------|--|----|
| 1. | Quickstart / Commissioning | 6 |
| 1.1. | Installing and connecting the met[LOG] | 6 |
| 1.2. | Connection of serial LAMBRECHT sensors | 8 |
| 1.3. | Auto configuration | 15 |
| 1. | | 15 |
| 1.4.1. | Award a firm IP address via SD card | 15 |
| 2. | Firmware updates | 16 |
| 3. | Configuration | 17 |
| 3.1. | General configurations | 17 |
| 3.2. | Configuration of the sensors | 19 |
| 3.2.1. | NMEA-Sensors | 20 |
| 3.2.2. | Talker protocol of the rain[e] | 20 |
| 3.2.3. | Configuration of the rain[e] SDI-12 on RS485 | 20 |
| 3.2.4. | Analogue/Digital-inputs | 21 |
| 3.3. | Configuration of the data storage | 25 |
| 3.4. | Configuration of the visualisation | 27 |
| 3.4.1. | Trend | 29 |
| 3.4.2. | Indicating elements | 29 |
| 3.4.2.1. | Indicating instrument wind speed | 30 |
| 3.4.2.2. | Indicating instrument wind direction | 30 |
| 3.4.2.3. | Numerical indicator | 31 |
| 3.4.2.3.1. | Peak wind speed | 32 |
| 3.4.2.3.2. | Maximum gust | 33 |
| 3.4.2.3.3. | Heat index / Humidex or wind chill | 33 |
| 3.4.2.3.4. | Dew point (measured or calculated) | 35 |
| 3.4.2.3.5. | Absolute air humidity | 35 |
| 3.4.2.3.6. | Air pressure (altitude corrected) | 35 |
| 3.4.2.3.7. | Air pressure above sea level - QNH | 35 |
| 3.4.2.3.8. | Air pressure above sea level - QFF | 35 |
| 3.4.2.3.9. | Sunshine duration (day) | 35 |
| 3.4.2.3.10. | Duration of precipitation (day) | 35 |
| 3.4.2.3.11. | Amount of precipitation (day) | 35 |
| 3.4.2.4. | History diagram | 36 |
| 3.4.2.5. | Trend display | 36 |
| 3.4.2.6. | Sector display | 36 |
| 3.4.2.7. | Status display | 36 |
| 4. | Loading of a stored configuration | 37 |
| 5. | Auto configuration | 37 |
| 5.1. | Talker-Sensors | 38 |
| 5.1.1. | rain[e]-Talker | 39 |
| 6. | Alert generation / management | 39 |
| 6.1. | Alert configuration | 39 |
| | Hysteresis function | 41 |
| | Window function | 41 |
| 7. | Data export as a CSV | 44 |
| 8. | Reset | 44 |
| 9. | Data collection | 45 |
| 9.1. | NMEA-protocol | 45 |
| 9.1.1. | Basics NMEA | 45 |
| 9.1.2. | Supported NMEA-telegrams | 46 |
| 9.1.2.1. | Data telegram WIMWV wind direction and wind speed | 46 |
| 9.1.2.2. | Data telegram WIMTA air temperature | 46 |
| 9.1.2.3. | Data telegram WIMMB air pressure | 46 |
| 9.1.2.4. | Data telegram WIMHU relative air humidity | 47 |
| 9.1.2.5. | XDR-Telegrams | 47 |
| 9.1.2.5.1. | XDR for the issue of the precipitation amount at EOLOS IND / WENTO IND | 47 |
| 9.1.2.5.2. | XDR Telegram format for temperature, humidity and air pressure | 47 |
| 9.1.2.5.3. | NMEA Checksum „CS“ | 48 |
| 9.2. | Protocol rain[e] | 48 |

| | | |
|----------|--|----|
| 9.2.1. | Talker-Protocol rain[e] | 48 |
| 9.2.2. | SDI-12 on RS485 – rain[e] | 48 |
| 9.3. | Analogue Sensors | 48 |
| 9.3.1. | Sensors with voltage output | 48 |
| 9.3.2. | Sensors with a status output | 48 |
| 9.3.3. | Sensors with frequency output | 49 |
| 9.3.4. | Rain gauges with pulse output | 49 |
| 9.3.4.1. | Rain gauges with pulse output - debouncing | 49 |
| 9.3.4.2. | Rain gauges with pulse output - linearization | 49 |
| 9.3.5. | NTC-temperature-sensors | 49 |
| 10. | Data storage | 50 |
| 10.1. | General | 50 |
| 11. | Annex..... | 51 |
| 12. | Data communication met[LOG] by HTTP..... | 51 |
| 12.1. | Identification of the logger | 51 |
| 12.2. | Access to the instantaneous values | 52 |
| 12.3. | Access to sliding wind data | 53 |
| 12.4. | Storage format..... | 54 |
| 12.4.1. | Formulas / Calculations | 55 |
| 12.4.2. | Annex – formula heating index | 55 |
| 12.4.3. | Annex – additional information regarding the heating index | 55 |
| 12.4.4. | Annex – formula Humidex | 55 |
| 12.4.5. | Annex – formula wind chill | 56 |
| 12.4.6. | Annex – formula dew point | 56 |
| 12.4.7. | Annex – formula absolute air humidity | 57 |
| 12.4.8. | Annex – formula air pressure altitude correction | 57 |
| 12.4.9. | Annex – formula air pressure over sea level QNH | 57 |
| 12.4.10. | Annex – formula air pressure over sea level QFF | 58 |
| 13. | Modification history | 59 |
| 14. | Warranty | 59 |
| 15. | Disposal | 59 |

1. Quickstart / Commissioning

The easiest and fastest commissioning is performed with the serial LAMBRECHT sensors:

- EOLOS-IND/-MET
- ARCO
- WENTO-IND/-MET
- 24513
- THP[pro]
- rain[e]

For these sensors, the met[LOG] has an auto-configuration feature.

Once the sensors have been installed, the commissioning will be done following below steps:

- 1.) Connect the met[LOG] to the power supply and the network and insert the microSD card
- 2.) Connect the sensors to the met[LOG]
- 3.) Start configuration by pushing the concealed button on the met[LOG] front (cavity)
- 4.) Call the met[LOG] web page by using the met[LOG] assigned IP address

In addition, the met[LOG] can be configured manually. Virtual measurements and alarms can be configured via the web page of the met[LOG].

1.1. Installing and connecting the met[LOG]

As power supply we recommend the LAMBRECHT meteo power[cube] (24 V/150 W).

The met[LOG] can be installed and connected into the power[cube] housing.

The power[cube] has additional connecting terminals to plug in the serial and analogue meteorological sensors of LAMBRECHT meteo.

Mounting on the profile rail

The met[LOG] can be fastened on the profile rail of the power[cube] and on every other 35 mm profile rail (DIN EN 60715).

After assembly of the met[LOG] on the profile rail push both white fastening clips (top and bottom of the met[LOG]) inwards.

The fastening clips can easily be dismantled by using a screwdriver.

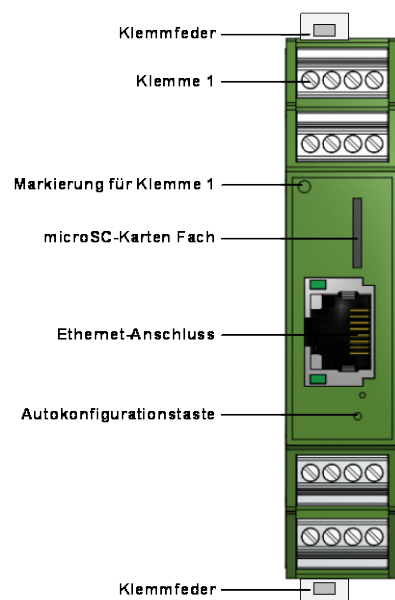

Inserting the microSD-card

The met[LOG] transfers and saves the measurement data onto a micro-SD card.

We recommend micro-SD cards suitable for industrial environments. These cards are working at larger temperature ranges and allow for more writing cycles than standard cards.

An industrial microSD card (8 GB) is available from LAMBRECHT meteo and local LAMBRECHT meteo partners (item# 32.95800.010000).

The micro-SD card slot is located on the front side of the met[LOG].

The card slot has a push-push-mechanism. The card is fixed with the first push and released with the second push.

For visualization of the measured values, the met[LOG] can be used without the microSD card.

Connecting to LAN

To connect the met[LOG] to LAN, please use a commercially available Ethernet cable.
For outdoor use, please make sure you apply materials that are approved accordingly, e.g. the power[cube] and UV-resistant cables.
Upon delivery, the met[LOG] is configured to an assigned IP-address from the DHCP server automatically.
An alternative IP-address can be chosen by using a special configuration.

Connecting to power supply

The dot (cycle) on the front side points in the direction of terminal 1.
The met[LOG] can be supplied with 11...32 VDC.
For power supply connection, use terminal 16 „+Power 11...32VCD“ and terminal 15 „System Ground“.

Attention! All analogue and digital inputs and all digital outputs refer to the „System Ground“.

Note: The supply voltage is switched to the digital outputs depending on the configuration and the alarm settings.

Wiring of met[LOG]

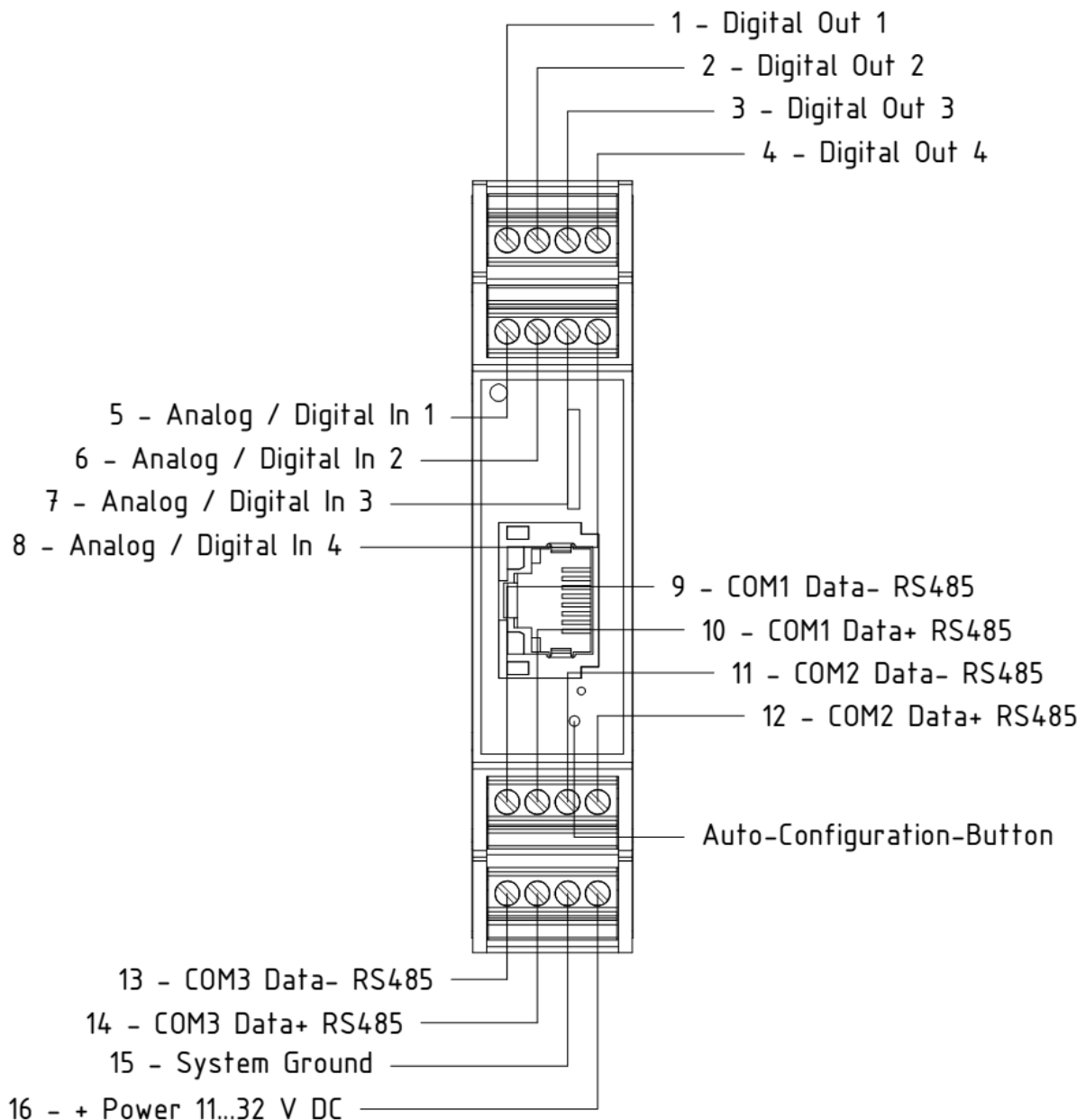

1.2. Connection of serial LAMBRECHT sensors

Installation of serial LAMBRECHT sensors is performed according to the appropriate sensor manual. Please read the appropriate sensor manual prior to operation with met[LOG].

Remark: Please note that the RS485 interfaces of met[LOG] are not decoupled/ isolated. In case of disruptions, a suitable galvanic separation has to be connected in front of the interfaces.

For fast entry the wiring diagrams of EOLOS, WENTO, ARCO, THP and rain[e] are shown in the following.

Wiring diagram EOLOS

Wettersensor EOLOS/IND-H
 weather sensor EOLOS/IND-H
 00.16430.010002
 (speed, direction, temperature, humidity, pressure)

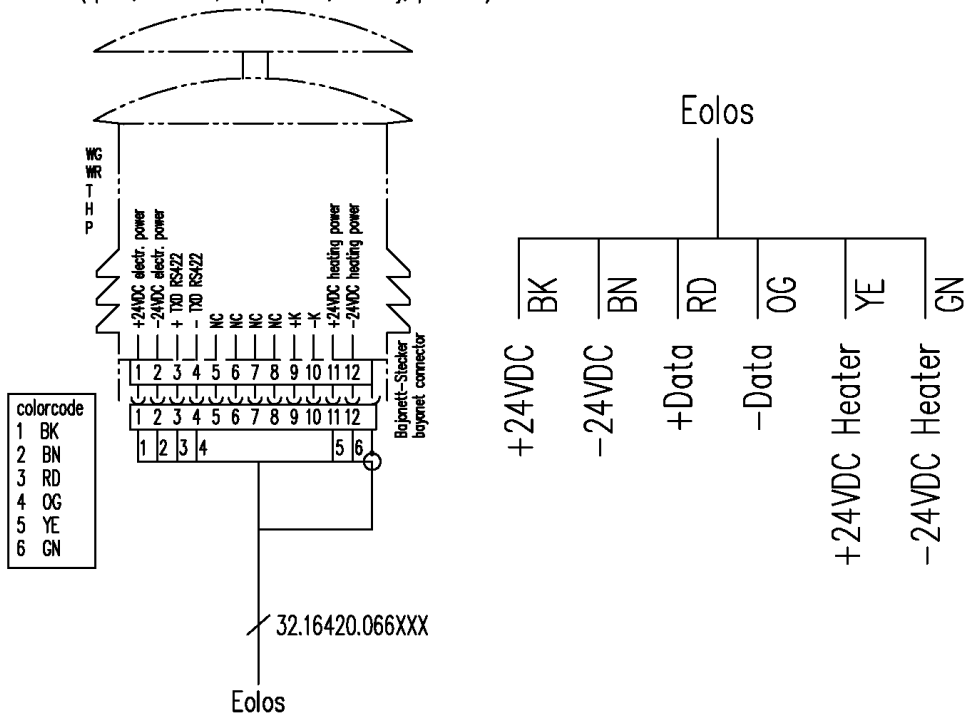

Wiring diagram THP[pro] Modbus

THP[pro] Modbus
 00.08095.100030

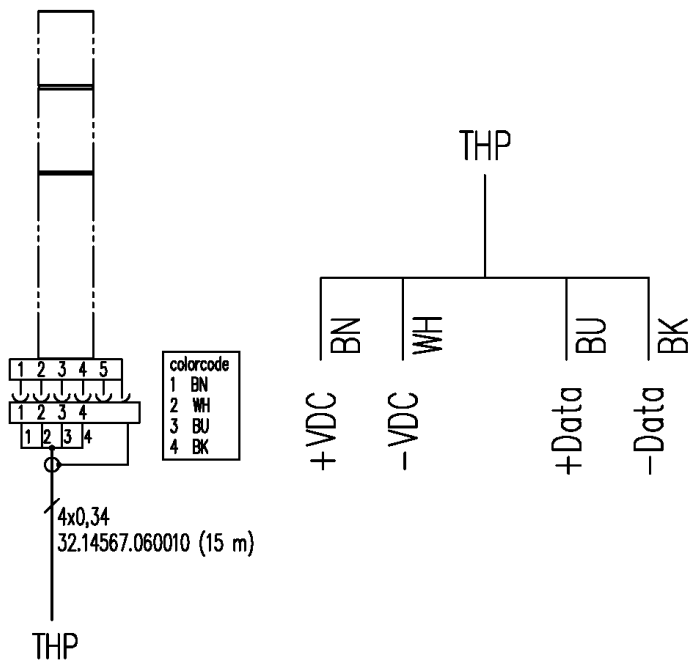

Wiring diagram ARCO-Modbus

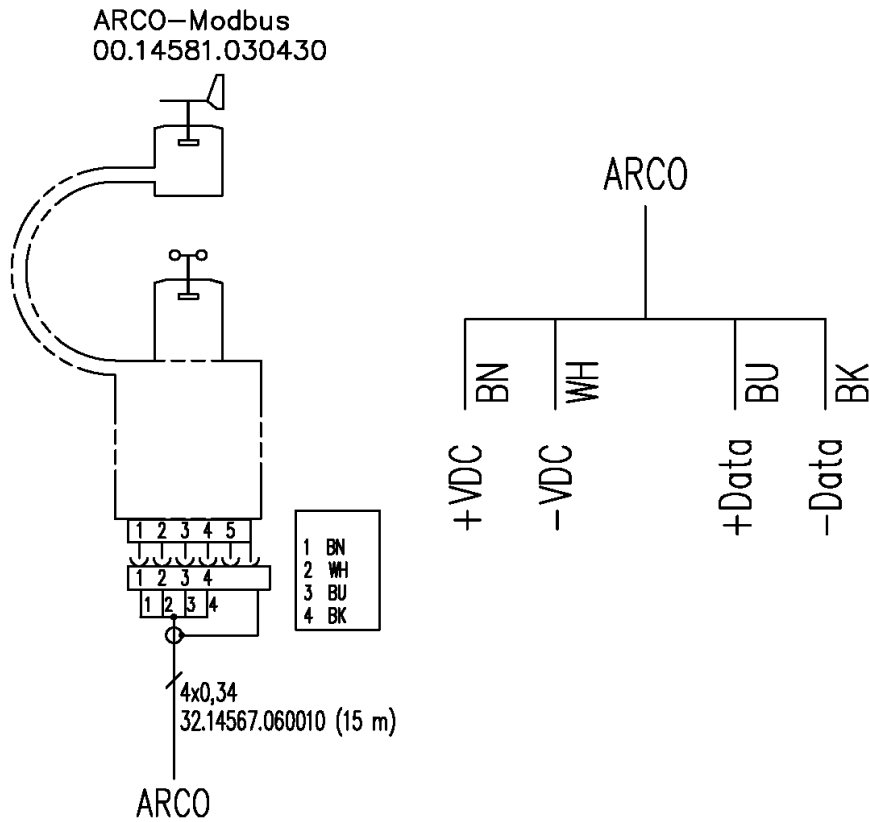

Wiring diagram u[sonic] Modbus / u[sonic]WS6 Modbus / u[sonic]WS7 Modbus

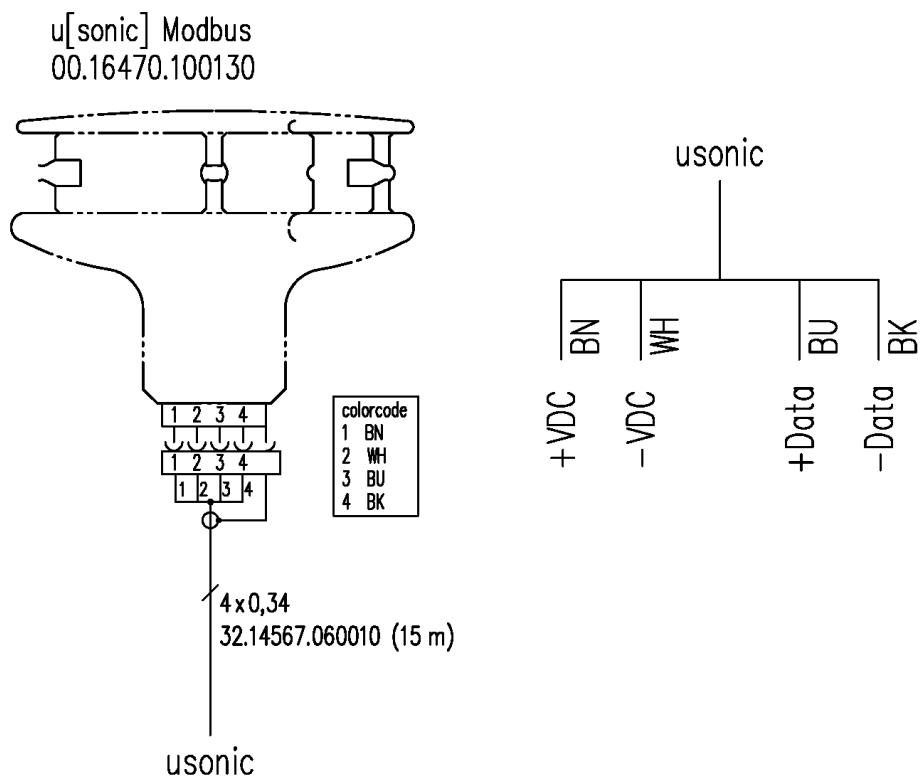

Wiring diagram rain[e] Modbus

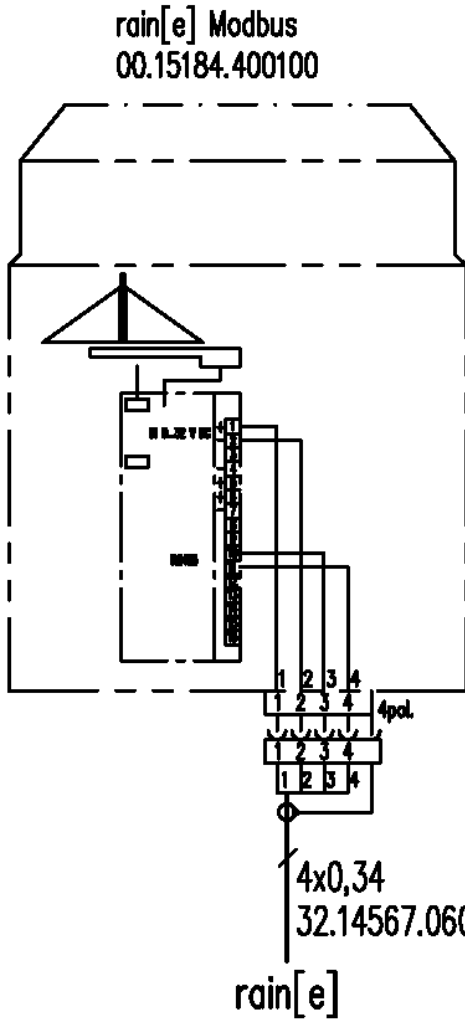

Supply & Communication

| | | |
|-----------------------|----|--|
| + IN 9...32 VDC | 1 | |
| - IN 9...32 VDC | 2 | |
| NC | 3 | |
| GND SDI-12 | 4 | |
| + DATA I/O SDI-12 | 5 | |
| + PULSE OUT | 6 | |
| - PULSE OUT | 7 | |
| + PULSE OUT ISO | 8 | |
| - PULSE OUT ISO | 9 | |
| + IN/OUT RS485 | 10 | |
| - IN/OUT RS485 | 11 | |
| + IN/OUT ANALOG RESET | 12 | |
| - IN/OUT ANALOG RESET | 13 | |
| + OUT VOLTAGE | 14 | |
| GND ANALOG | 15 | |
| + OUT CURRENT | 16 | |

Connection example with power[cube] + met[LOG] + EOLOS-Modbus + rain[e] Modbus

power[cube] + met[LOG]
mit Eolos, rain[e] Modbus

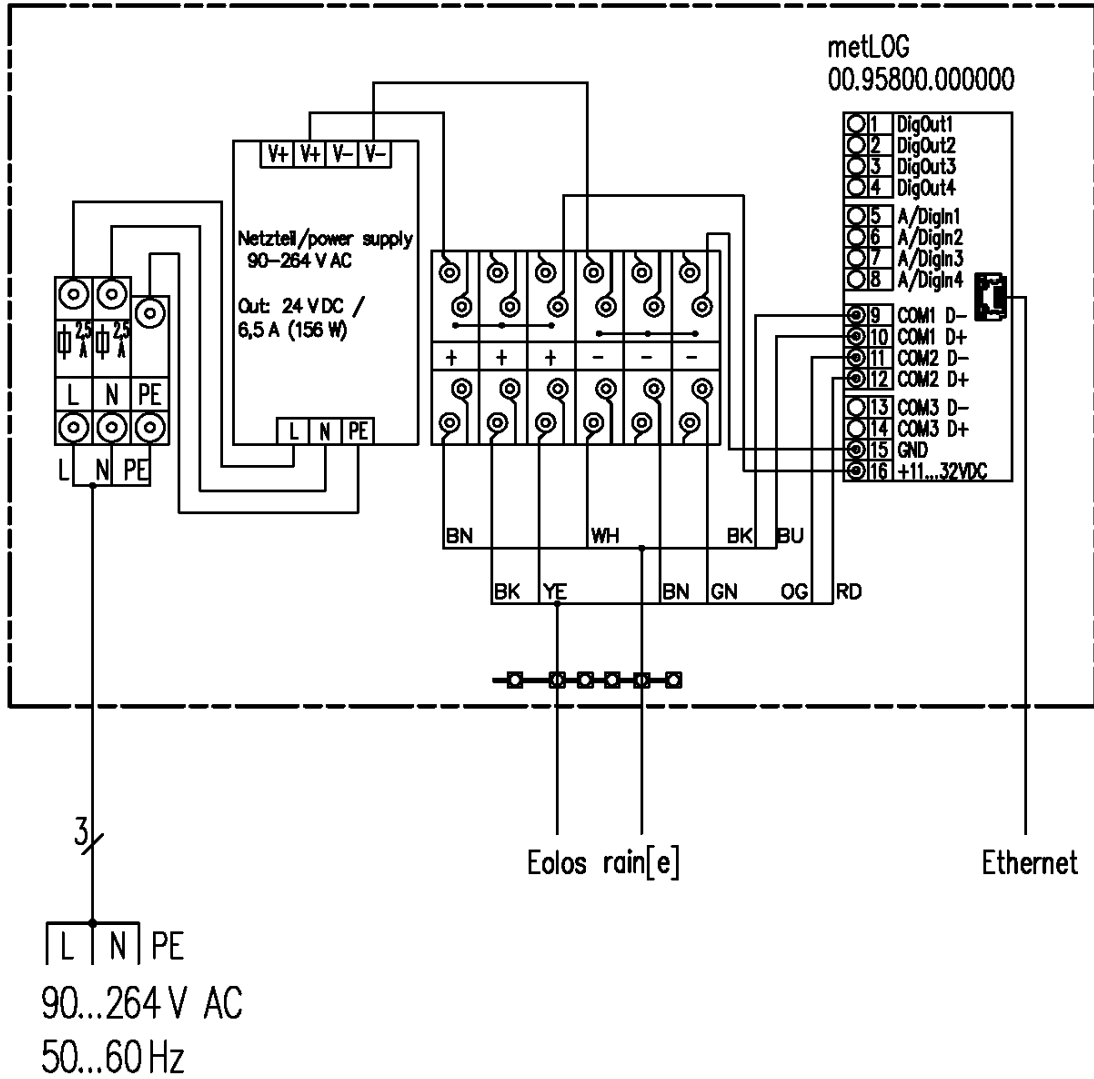

| AWG-cable colorcode | |
|---------------------|----|
| 1 | BK |
| 2 | BN |
| 3 | RD |
| 4 | OG |
| 5 | YE |
| 6 | GN |
| 7 | BU |
| 8 | VT |
| 9 | GY |
| 10 | WH |

1.3. Auto configuration

In combination with the LAMBRECHT meteo sensors EOLOS, ARCO, THP[pro], and rain[e], the met[LOG] has an auto configuration function.

Auto configuration is initiated by pushing the auto configuration button on the front side of the met[LOG]. Auto configuration is complete after approx. 5 – 8 minutes, depending on the number and the type of the connected sensors. During the auto-configuration, the status LED blinks red on the front of the met[LOG]. <http://de.pons.com/übersetzung/englisch-deutsch/>

The met[LOG] identifies talker protocols independently sent per COM interface, and initiates the parameters accordingly.

Each COM interface is visually grouped and indicates the received parameters. <http://de.pons.com/übersetzung/englisch-deutsch/only> Only real-time measuring values are automatically configured. Virtual measuring values can be added manually afterwards.

Measured parameters are automatically added to the log list and are saved in 1-minute intervals.

Other configurations (e.g. alarms) can be carried out manually.

<http://de.pons.com/übersetzung/englisch-deutsch/>

Following completed auto configuration, the auto-configuration button switches off. An erroneous new auto configuration is thus prevented.

ATTENTION! Initialising a new auto configuration will erase all previous configurations (manual or automatic). <http://de.pons.com/übersetzung/englisch-deutsch/>

Auto-configuration can be activated in the „general settings“ of the met[LOG] any time.

<http://de.pons.com/übersetzung/englisch-deutsch/>

Alternatively, configuration of the sensors can also be done manually.

1.4. Calling the integrated web page

The met[LOG] has an integrated web page. With the web page, real-time values can be indicated and an extensive configuration can be carried out. The web page can be used with any browser capable of HTML5. <http://de.pons.com/übersetzung/englisch-deutsch/>

Tip: If the web page is not properly indicated or not indicated at all, please update your browser version.

As soon as the met[LOG] is connected to a server, the IP address is automatically assigned to it by DHCP server as soon as it is on a network. If there is no DHCP server (this is the case when it is connected directly with the PC) a firm IP address can also be awarded to the met[LOG] via SD card.

<http://de.pons.com/übersetzung/englisch-deutsch/>

1.4.1. Award a firm IP address via SD card

When required, a firm IP address can be awarded to the met[LOG] via SD card.

<http://de.pons.com/übersetzung/englisch-deutsch/>

For this a file with the name:

\$config.cfg

has to be set on the SD card.

In the file, the following command lines have to be given:

```
{ "method": "POST", "path": "/config/net", "data": { "dhcpEnabled": 0, "ipAddr": "192.168.1.2", "maskAddr": "255.255.255.0", "gwAddr": "192.168.1.1", "DNS": "192.168.1.1" } }
{ "method": "POST", "path": "/config/saveconfig" }
```

Example – line breaks:

```
{ "method": "POST", "path": "/config/net", "data": { "dhcpEnabled": 0, "ipAddr": "192.168.1.2", "maskAddr": "255.255.255.0", "gwAddr": "192.168.1.1", "DNS": "192.168.1.1" } }
{ "method": "POST", "path": "/config/saveconfig" }
```

ATTENTION It is important that the file always ends with a new line (enter line break)!

With these commands this is set:

| | | |
|-----------------|-------------|---------------|
| firm IP address | "ipAddr": | 192.168.1.2 |
| Subnet | "maskAddr": | 255.255.255.0 |
| Gateway | "gwAddr": | 192.168.1.1 |
| DNS | "DNS": | 192.168.1.1 |

This way, any other firm IP address can be awarded. <http://de.pons.com/übersetzung/englisch-deutsch/>

ATTENTION! By manual assignment of IP addresses on a network please pay attention that per one network point only one device with this IP address is allowed.

<http://de.pons.com/übersetzung/englisch-deutsch/>

Tip Pay attention to the creation of the file as the file with the correct file ending is saved: „All files (*.*)“ store (file type with).

If the known file ends are faded out under Windows, it may happen that Windows automatically adds an invisible file ending in the file name. In this case the configuration file is not read!

If there is a password set, it should be added to the SD card before accepting the configuration.

Please use the following command:

```
{"method":"POST","path":"/system/access","data":{"PWD":"abc"}}
```

Note: "abc" has to be substituted with the respective password, e. g. , "1234".

<http://de.pons.com/übersetzung/englisch-deutsch/>.

```
{"method":"POST","path":"/system/access","data":{"PWD":"abc"}}
```

Whereat "abc" has to be replaced by the respective password; e.g.. "1234".

2. Firmware updates

Firmware updates take place in a simple way via SD card. The actual firmware with the file name "\$update bin" has to be stored on the memory card and to be put into the met[LOG].

After the met[LOG] has been disconnected from the power supply and turned on again it loads the new firmware.

Following the update, the file "\$update bin" won't be deleted automatically but can remain on the SD-card.

3. Configuration

The met[LOG] can be configured via its integrated web page. The languages German (DE) and English (EN) are available. It is possible to switch between the languages on any page of the met[LOG].

Each configuration page must be stored individually. Thus, the blue button with disk symbol must be pressed. The button appears automatically as soon as the first configuration which requires a reboot has taken place .



After pressing the storage button, the met[LOG] will reboot. Following the reboot, the network is not available for about 10 seconds. After 10 seconds the met[LOG] web page can be displayed again. In case of not storing a configuration, it will be deleted with the very first change of a web page.

3.1. General configurations

Via the 'General link', the user accesses the web page for general adjustments. When the password protection has been activated, the links are not available for configuration until the user logs in via the login button. Only real time measurement values can be displayed.

| Einstellungen | |
|----------------------|---|
| Einheit | |
| Einheit Temperatur | <input type="radio"/> °C <input type="radio"/> °F |
| Einheit Druck | <input type="radio"/> mBar <input type="radio"/> hPa |
| Allgemein | |
| Gerätename | <input type="text" value="met[LOG]"/> |
| MAC-Adresse | 38:F5:97:00:03:52 |
| IP-Adresse | 192.168.243.253 |
| Firmware Version | 1.0.0.12 |
| CPU Temperatur | 37.6 °C |
| Zeit | 67h 58m 57s |
| SD-Karte vorhanden? | Vorhanden |
| Konfiguration auf SD | <input type="text"/> <input type="button" value="speichern"/> |
| Auto Konfiguration | <input type="button" value="Ja"/> |

Unit

Here the globally valid units of the measured and calculated temperatures and air pressures can be adjusted for visualization

For temperature, °C and °F can be selected, respectively. For air pressure, the choice is between mbar or hPa.

General

Here the name of the device can be changed, by which the met[LOG] is logged to the network.

Moreover, the device data:

- MAC-Address
- IP-Address
- Firmware version
- CPU-Temperature
- Time (since the last reset or rather. restart)
- SD-card inserted

can be read.

If a SD-card is inserted, the configuration of the met[LOG] can be stored on the SD-card under a file name of your choice.

Auto configuration mode can be activated/deactivated here.

Activate Access Protection

Zugangsschutz aktivieren

| | |
|----------------------|---------------------------------------|
| Benutzername | <input type="text" value="mmueller"/> |
| Passwort | <input type="password"/> |
| Passwort wiederholen | <input type="password"/> |

To avoid non authorized modification of the configuration, a password protected access protection can be activated. The met[LOG] has no user management. Therefore, one user and one password can be assigned.

Network

Per default, the met[LOG] is set up for automatic (dynamic) assignment of it's IP-address by the DHCP-server. Having deactivated the DHCP-function, a firm IP-address can be assigned to the met[LOG].

Netzwerk

| | |
|---------|--|
| DHCP | <input checked="" type="checkbox"/> Ja |
| IP | <input type="text" value="169.254.0.3"/> |
| Mask | <input type="text" value="255.255.255.0"/> |
| Gateway | <input type="text" value="0.0.0.0"/> |
| DNS | <input type="text" value="8.8.8.8"/> |

A firm IP-address is e.g. necessary if the met[LOG] needs to be connected directly to a PC. During initial commissioning, a fixed IP-address can be assigned via a configuration file on the SD-card.

Time

Current time and date can be set manually or can be adjusted automatically via a time server.

| Zeit | |
|-----------------|---|
| UTC | Mon Jan 25 2016 15:02:31 |
| Lokalzeit | Mon Jan 25 2016 15:02:31 |
| Time server | <input type="text" value="Name oder IP (max 20 characters)"/> |
| Time source | <input type="button" value="Manuell"/> ▾ |
| Zeit einstellen | <input type="button" value="Monat"/> ▾ <input type="button" value="Tag"/> ▾ <input type="button" value="Jahr"/> ▾ <input type="text" value="00"/> : <input type="text" value="00"/> <input type="button" value="Aktivieren"/> |
| Zeitzone | <input type="button" value="WET"/> ▾ |
| Offset | <input type="text" value="0"/> min |
| Sommerzeit | <input type="button" value="AUS"/> ▾ |

Under „time source“, chose whether the time shall be set manually, automatically via network (internet) or whether by an inserted server under “time server”.

Remark: For the manual time registration, time source “manually” has to be chosen and to be stored. After day, month, year, hour (24 hours) and minute have been set, they can be taken over by the met[LOG] by pressing the button “activate”.

3.2. Configuration of the sensors

On the page “sensors” the COM interfaces can be activated, and the analogue/digital inputs can be configured.

On the COM interfaces, protocols can be chosen.

Available for selection:

- NMEA
- rain[e] talker
- rain[e] SDI-12 on RS485
- MODBUS RTU

| COM1 | |
|--|--|
| <input checked="" type="button" value="EIN"/> <input type="button" value="AUS"/> | <input type="checkbox"/> TCP <input checked="" type="checkbox"/> Sensor device |
| <input checked="" type="checkbox"/> NMEA [IN] | <input type="checkbox"/> NMEA TW [OUT] |
| <input checked="" type="checkbox"/> WIMWV | <input type="checkbox"/> rain[e] Talker [IN] |
| <input checked="" type="checkbox"/> WIMTA | <input type="checkbox"/> rain[e] SDI-12 [IN] |
| <input checked="" type="checkbox"/> WIMMB | <input type="checkbox"/> Modbus RTU |
| <input checked="" type="checkbox"/> WIMHU | |
| <input type="checkbox"/> WIXDR (C/H/P) | |
| <input type="checkbox"/> WIXDR (PR) | |
| <input type="checkbox"/> HEOSD | |

3.2.1. NMEA-Sensors

Using NMEA-sensors, the telegrams [IN] can be chosen which the met[LOG] reception shall evaluate. Available for selection:

- WIMWV
- WIMTA
- WIMMB
- WIMHU
- WIXDR (PR)
- WIXDR (C/H/P)

(For a detailed description of the telegrams please also see chapter 9.1).

Alternatively, a result output of a true wind calculation (NMEA TW [OUT]) can be issued via a COM-interface

3.2.2. Talker protocol of the rain[e]

Having chosen the COM-interface of the rain[e]-talker, following measuring values for further configurations of the visualisation and the data storage are available:

- The intensity in mm/min
- The total amount in mm (amount of precipitation each storage interval)
- The heating status
- Internal temperature in °C
- The system status

The total amount indicates the collected precipitation in mm since the device has been switched on. From the total amount, the met[LOG] calculates the amount of precipitation (in mm) for each storage interval.

3.2.3. Configuration of the rain[e] SDI-12 on RS485

If the measured values of the rain[e] are collected via the SDI-12 protocol on RS485, data call interval can be set up via the met[LOG].

Measured values are collected every 10 seconds (at standard configuration).

Available selection:

- Intensity of precipitation last minute in mm/min
- Amount of precipitation since last call mm/m²
- Internal temperature °C
- Heating ON (1) / OFF (0)
- Total heating capacity %
- All error states:
 - Error code for LAMBRECHT-service 0...99
 - Error exceeding of 10° C at heating ON 0 or 1
 - Error heating 0 or 1
 - Error temperature sensor interior space 0 or 1
 - Error temperature sensor at the funnel 0 or 1
 - Just for LAMBRECHT-Service 4 0 or 1
 - Just for LAMBRECHT-Service 5 0 or 1
 - Just for LAMBRECHT-Service 6 0 or 1
 - Just for LAMBRECHT-Service 7 0 or 1

Units, decimals and sensor type of the available rain[e] parameter are listed in the following diagram:

| Sensor designation | Unit | Decimal places | Type |
|---|--------|----------------|------|
| Intensity of precipitation | mm/min | 0,000 | N |
| Amount of precipitation | mm | 0,000 | N |
| Internal temperature | °C | 0,0 | T |
| Heating ON (1) / OFF (0) | % | 0 | Z |
| Total heating capacity % | % | 0 | Z |
| Error code for LAMBRECHT-service | --- | 0 | Y |
| Error exceeding of 10° C at heating ON | --- | 0 | Z |
| Error heating | --- | 0 | Z |
| Error temperature sensor interior space | --- | 0 | Z |
| Error temperature sensor at the funnel | --- | 0 | Z |
| Just for LAMBRECHT-Service 4 | --- | 0 | Z |
| Just for LAMBRECHT-Service 5 | --- | 0 | Z |
| Just for LAMBRECHT-Service 6 | --- | 0 | Z |
| Just for LAMBRECHT-Service 7 | --- | 0 | Z |

3.2.4. Analogue/Digital-inputs

Analogue/digital-inputs allows for selection of analogue sensors with a voltage output, digital sensors with frequency, impulse or status output or NTC-temperature sensor.

A/D IN 1 ▾ ▾

- Spannung 0...10V
- Digital IN / Status
- NTC-Temperatursensor
- Impuls
- Frequenz

Apart from the signal type, a sensor designation, the unit, the number of decimal places and the sensor type (A_____) have to be assigned. The list of the available sensor types can be found in the chapter 12.1. These parameters will be taken over into the sensor list (chapter 3.3).

Voltage sensor

In case of a voltage sensor, the voltage range (min./max.) and the corresponding scaling can be entered. Following options can be chosen: To suppress (and ignore) an exceeding or underrunning of the voltage range or to put the corresponding measuring value on "overscale". In case of suppressing the exceeding or the underrunning, the value will be put on the respectively permitted extreme value.

A/D IN 1 Sensorbezeichnung Einheit 0 A

Spannung 0...10V

Digital IN / Status

NTC-Temperatursensor

Impuls

Frequenz

Spannungsbereich min.

Spannungsbereich max.

Skalierung min.

Skalierung max.

Werte ausserhalb min./max. unterdrücken

Digital signals

Digital signals can be:

- Status
- Impulse
- Frequency

If necessary, a debouncing software can be activated for the status or the impulse. Thereby the number of the permitted impulses per second will be limited to a maximum of 3 per second (3 Hz).

Status

Using digital signals, it can be adjusted, whether there is an active signal with low or high level or a passive signal (e.g. relay or OC). At an active signal the voltage values for the high and low level can be adjusted. Moreover it can be chosen, whether the status is high active or low active.

A/D IN 1 Sensorbezeichnung Einheit 0 A

Spannung 0...10V

Digital IN / Status

NTC-Temperatursensor

Impuls

Frequenz

Entprellung Aktiv Passiv

Low-Pegel in V

High-Pegel in V

High-aktiv Low-aktiv

ATTENTION ! Upon passive signal, the met[LOG] power supply will be interconnected as a switching voltage.

Impulse

Using the digital input for a rain gauge, the scaling for the sensor has to be adjusted (1 impulse = x mm). Moreover, a correction of the intensity for the LAMBRECHT precipitation sensors can be activated. The impulse will always be counted with the positive edge; therefore thresholds doesn't have to be inserted.

ATTENTION ! At a passive impulse (e.g. of a rain gauge) the power supply in the met[LOG] will be interconnected as a switching voltage.

Frequency

At the frequency the frequency range (min./max.) and the scaling can be adjusted.

It is possible to choose an active signal with low and high level or a passive signal (e.g. relay or OC). Moreover, it is possible to select whether the frequency is high active or low active. The frequency will always be counted with the positive edge; therefore thresholds doesn't have to be inserted.

ATTENTION ! At passive signal, the power supply in the met[LOG] will be interconnected as a switching voltage.

NTC-temperature sensor

Temperature measurement with the NTC-temperature sensor is possible. For the NTC the R0 resistance value is in kOhm and its B-value has to be inserted.

| A/D IN 1 | Sensorbezeichnung | Einheit | 0 | A |
|---|-------------------|---------|----------------------|---|
| <input type="checkbox"/> Spannung 0...10V | R0 (kOhm) | | <input type="text"/> | |
| <input type="checkbox"/> Digital IN / Status | B-Value | | <input type="text"/> | |
| <input checked="" type="checkbox"/> NTC-Temperatursensor | | | | |
| <input type="checkbox"/> Impuls | | | | |
| <input type="checkbox"/> Frequenz | | | | |

3.3. Configuration of the data storage

For data storage, the storage interval (equals mean value interval) has to be adjusted. 1, 2, 5 or 10 minutes can be selected.

Datenspeicherung

1 Minute ▾

Log Liste ✖

| | | | | | |
|----|----------------|-----|---------------|--------------|------------|
| 1. | wind direction | deg | No data (0.0) | Windrichtung | COM 1 (21) |
|----|----------------|-----|---------------|--------------|------------|

Sensor Liste +

| # | Name | Einheit | Dezimalstellen | Sensortyp | Sensor (ID) |
|----|----------------------|---------|----------------|---------------------|----------------|
| 1. | wind direction | deg | 1 (0.0) | Windrichtung | COM 1 (21) |
| 2. | wind speed | m/s | 1 (0.0) | Windgeschwindigkeit | COM 1 (37) |
| 3. | air temperature | C | 1 (0.0) | Temperatur | COM 1 (181) |
| 4. | atmospheric pressure | hPa | 1 (0.0) | Luftdruck | COM 1 (341) |
| 5. | rel. humidity | % | 1 (0.0) | Feuchte | COM 1 (501) |
| 6. | dew point | C | 1 (0.0) | Taupunkt | COM 1 (517) |
| 7. | Hitzeindex | C | 1 (0.0) | Temperatur | Virtual (2383) |

Via drag 'n' drop or via the „+“ button, sensor parameters from the sensor list can be dragged into the log list. The sensor parameter list is a result from the configuration of the “analogue/digital inputs” and configuration of the telegrams at COM-interfaces. All parameters in the log list will be stored according to the adjusted storage interval as mean value, minimum value, and maximum value (please see chapter 10)

If available, virtual parameters from the list of the virtual sensors can be put and stored in the log list. The virtual sensors result from the configuration of the visualization.

Gruppen

Liste der virtuellen Sensoren

| # | Typ | Name | VID(s) |
|---|-----------------------|------------|--------|
| 1 | Hitze-Index/Windchill | Hitzeindex | 2383 |

Sensors which are inside the log list are shown in grey in the original list and cannot be moved back into the log list.

Via the dustbin button the logged sensors can be removed from the log list.

ATTENTION ! At passive signal, the power supply in the met[LOG] will be interconnected as switching voltage.

In case of modification of the log list after storage of a configuration and rebooting of the met[LOG], all log files (BIN files) which have been stored until the configuration will be deleted at the next storing/rebooting. This is necessary as the sensor assignment of the measuring values stored in the log data otherwise is no longer valid. In case these values be required, they must be exported before. An export can be made via CSV-file or with the LAMBRECHT evaluation and visualisation software MeteoWare CS3.

Name, the unit which has to be stored and the number of the decimal places can be adjusted in the log list.

Log Liste [X]

COM 1 (21) [X]

The unit can be assigned freely. For future evaluations, e.g. with the MeteoWare CS, we recommend to use the units according to the following list:

List of the recommended units:

| Parameter | Unit |
|-------------------|------------------------------|
| absolute humidity | g/m ³ |
| Air pressure | hPa |
| Air pressure | Inch Hg |
| Temperature | °C |
| Dew point | °C |
| rel. Humidity | % |
| Wind speed | m/s |
| Wind speed | km/h |
| Wind speed | kt (at Sea / at Nato planes) |
| Wind direction | ° / degree |
| Heading | ° / degree |
| Course | ° / degree |
| Boat speed | Kt |
| Voltage | V |
| Voltage | MV |
| Current | A |
| Current | MA |
| Frequency | Hz |
| Resistance | Ohm |
| Visibility | m / km |
| Ceiling | m / feet |
| Leaf wetness | % |
| Precipitation | mm/m ² |
| Global radiation | W/m ² |
| Net radiation | W/m ² |
| rain[e] Heating | % |
| Sunshine duration | % |
| Sunshine duration | Minutes |
| Brightness | Klx |
| Event | % |
| Status | % |

3.4. Configuration of the visualisation

The visualisation will be configured directly on the page „files“, on which the current values are displayed.

The measurement values to be displayed can be summarised in groups.

A group can be created via the button “add group to the left” or “add group to the right”.



In the open window, the name of the group has to be entered.

Subsequently can be chosen, whether in this group an actual value or a virtual value has to be displayed.

Neue Gruppe erstellen

Name der Gruppe

3 bis 20 Zeichen

Typ des Wertes auswählen

Ist-Werte

Sensor Werte hinzufügen

Virtuelle Werte

Berechnete Werte hinzufügen

After pressing “actual values“ the met[LOG] displays all the available current values which have been recognised in the auto-configuration or which have been set under “sensor”.

Neue Gruppe erstellen

Name der Gruppe

EOLOS

Typ des Wertes auswählen

Ist-Werte

Sensor Werte hinzufügen

Virtuelle Werte

Berechnete Werte hinzufügen

Wert auswählen

wind direction
COM 1 (21)

wind speed
COM 1 (37)

air temperature
COM 1 (181)

atmospheric pressure
COM 1 (341)

rel. humidity
COM 1 (501)

dew point
COM 1 (517)

In the example, an EOLOS-IND provides measuring values for wind direction, wind speed, temperature, relative humidity, air pressure and dew point.

Neue Gruppe erstellen

Name der Gruppe

EOLOS

Typ des Wertes auswählen

Ist-Werte

Sensor Werte hinzufügen

Virtuelle Werte

Berechnete Werte hinzufügen

Wert auswählen

wind direction

COM 1 (21)

wind speed

COM 1 (37)

air temperature

COM 1 (181)

atmospheric pressure

COM 1 (341)

rel. humidity

COM 1 (501)

dew point

COM 1 (517)

Actual value options

Type

Graph

Erstellen

For the respective parameter, selection can be made between graphical "graph" or numerical "box". For the wind measuring values the wind indicators will be shown, choosing "graph". Finally, by pressing the button "create" the group with the chosen indicating instrument will be generated. Further display elements can be added to the group by pressing the "+" button.

Example of visualisation of the current values of the EOLOS

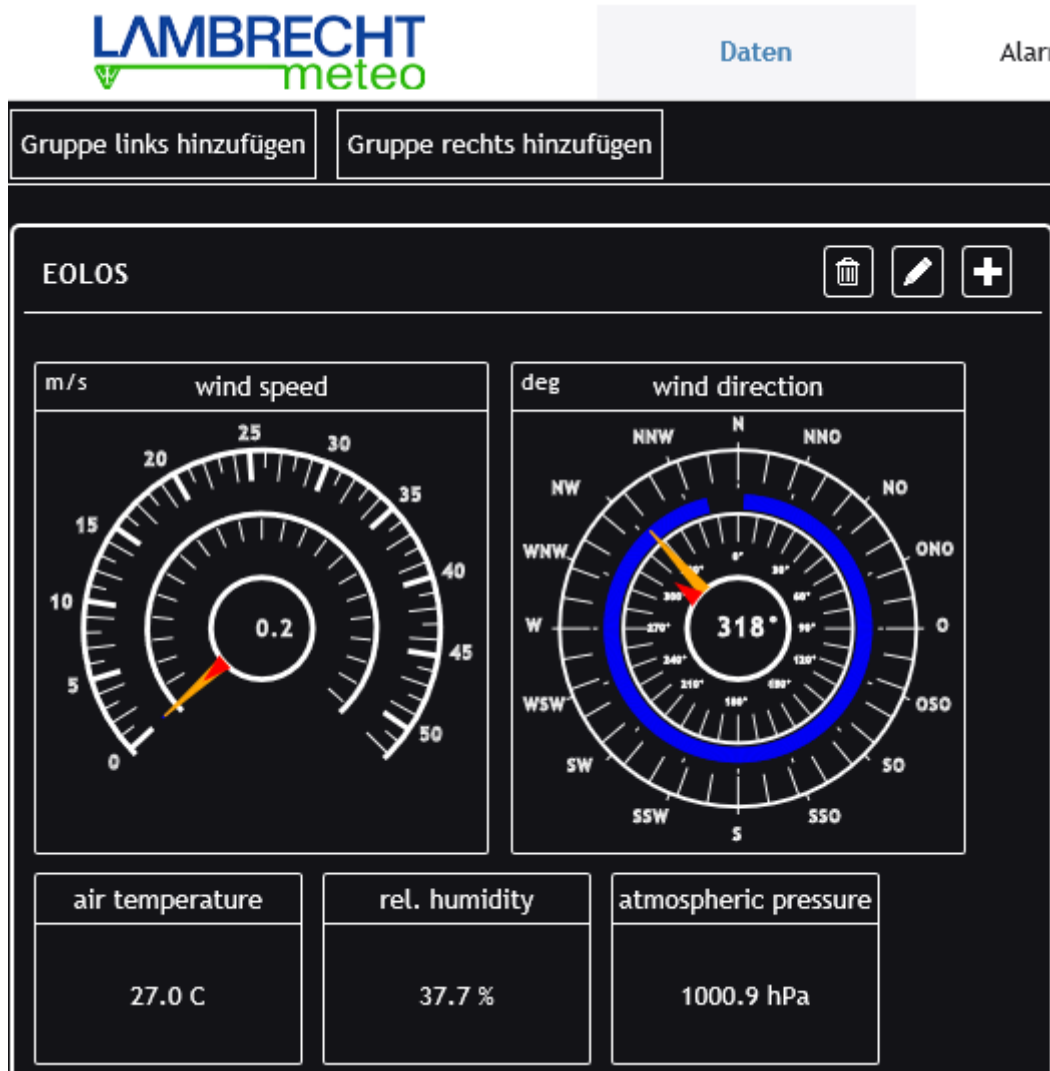

3.4.1. Trend

For some parameters e.g. temperature, a trend display can be inserted (see also chapter 3.4.2.5). Under trend, the time base for the trend calculation can be adjusted: 10 minutes, 30 minutes, 1 hour and 3 hours. When the trend is deactivated (trend=OFF), it will not be shown in the corresponding display.

3.4.2. Indicating elements

The met[LOG] recognizes the following indicating elements:

- Indicating instrument wind speed
- Indicating instrument wind direction
- Numerical indicator
- History diagram
- Trend diagram
- Sector diagram
- Status diagram

3.4.2.1. Indicating instrument wind speed

The instrument wind speed displays the current wind speed (long yellow hand) and the average wind speed (short red hand). The blue sector marks the range between the maximum and the minimum wind speed. The inner circle indicates the numerical wind speed.

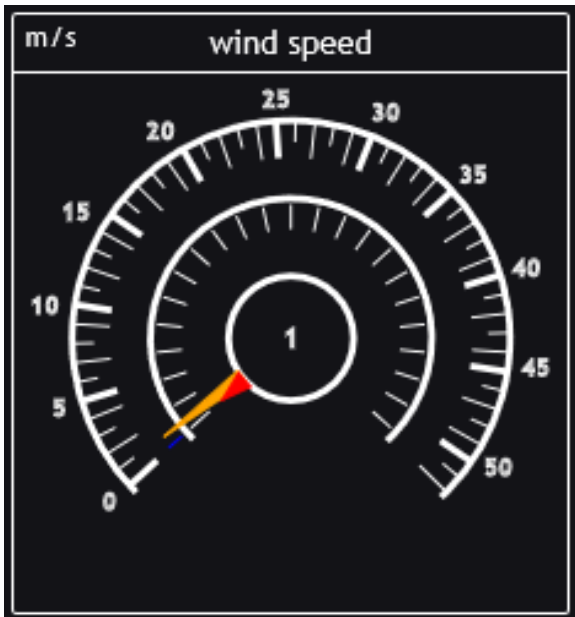

3.4.2.2. Indicating instrument wind direction

The instrument wind direction displays the current wind direction (long yellow hand) and the average wind direction (short red hand). The blue sector indicates the range within which the wind direction has moved in the configured time interval. The inner circle indicates the numerical wind direction.

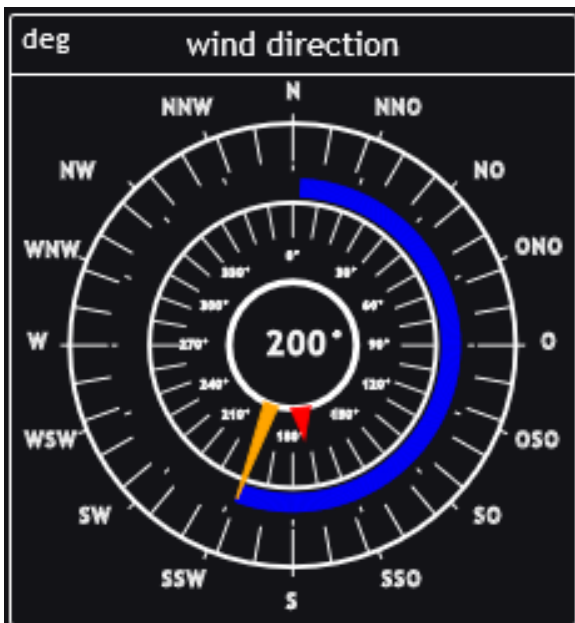

3.4.2.3. Numerical indicator

The numerical indicator displays the respective current value.



In addition to the measured actual values, virtual values can be indicated. These virtual measured values can also be stored.

Calculated parameters are:

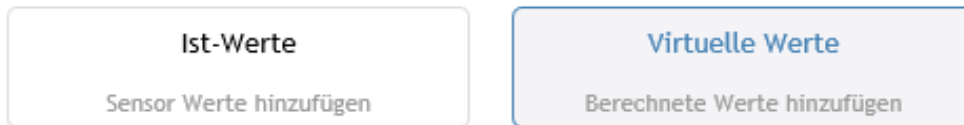

Wert auswählen

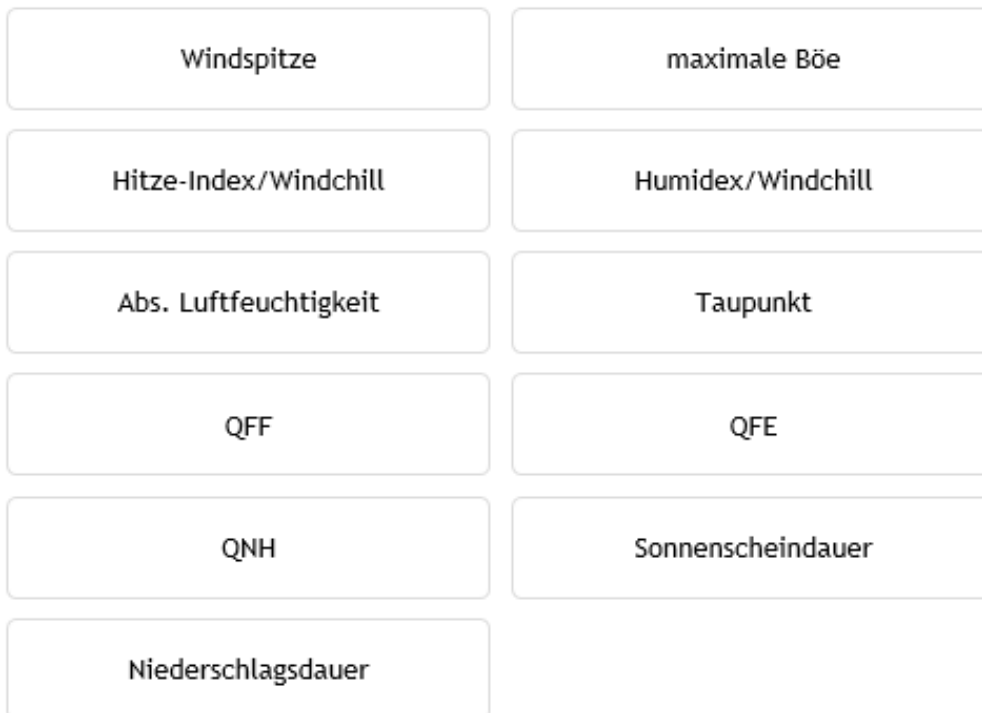

3.4.2.3.1. Peak wind speed

At peak wind speed, two values will be indicated in the numerical display: the maximum wind speed and the wind direction at the time of the peak.

For the determination, the wind speed and the wind direction will be linked vectorially and for the display counted back again.

The time frame for which the peak wind speed has to be determined is adjustable in a range from 1 to 10 minutes. This is a sliding time frame which is moved forward inside the update interval of the display.

For the calculation of the peak wind speed a wind speed sensor always has to be linked with a wind direction sensor. The linking takes place by choosing the respective wind sensor.

Wert auswählen

| | |
|-----------------------|-------------------|
| Windspitze | maximale Böe |
| Hitze-Index/Windchill | Humidex/Windchill |
| Abs. Luftfeuchtigkeit | Taupunkt |
| QFF | QFE |
| QNH | Sonnenscheindauer |
| Niederschlagsdauer | |

Sensor auswählen

Virtueller Name

| | |
|----------------|-----------------------|
| Wind speed | -- Sensor auswählen ▾ |
| Wind direction | -- Sensor auswählen ▾ |

3.4.2.3.2. Maximum gust

The meteorological definition of a gust is, when the measured ten-minute-mean of the wind speed exceeds within a few seconds for at least 3 seconds and maximally 20 seconds. The maximum gust is the maximum difference of a gust to a neighbouring lull. The reference lull can be the one before (+) or after (-) the gust.

Example of a maximum gust

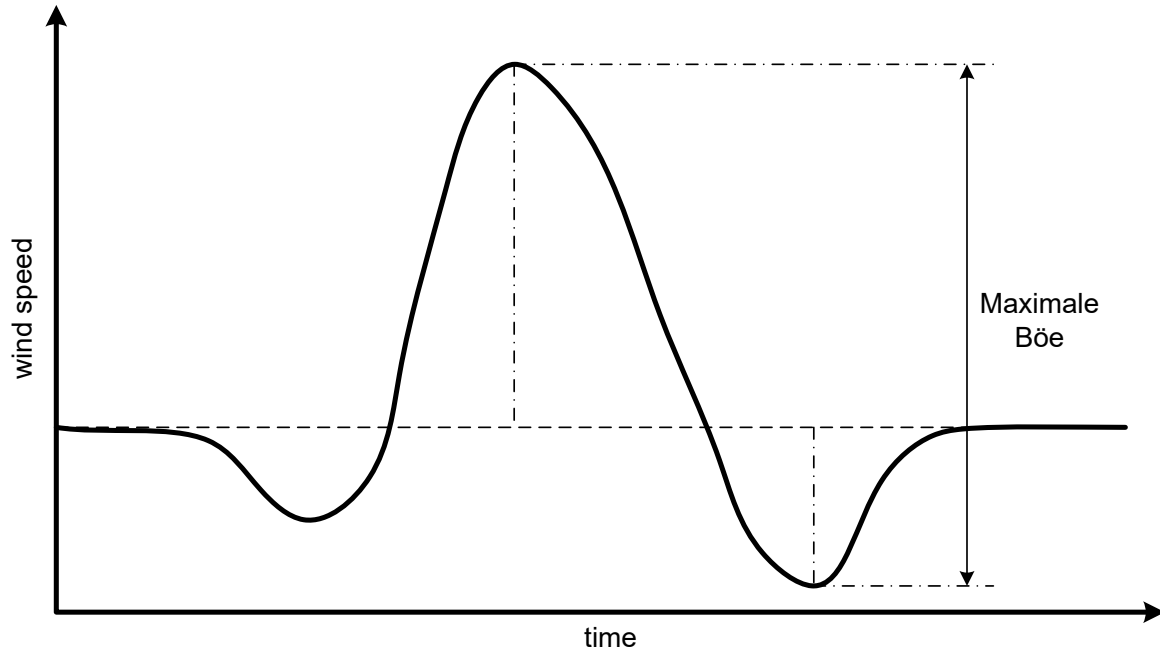

3.4.2.3.3. Heat index / Humidex or wind chill

For the calculation of the heat index and humidex additionally the relative humidity and for the calculation of the wind chill, the wind speed is needed.

Sensor auswählen





Virtueller Name

| | |
|-------------|-----------------------|
| Wind speed | -- Sensor auswählen ▼ |
| Temperature | -- Sensor auswählen ▼ |
| Humidity | -- Sensor auswählen ▼ |

The heat index

The heat index is a calculated parameter that combines air temperature and relative humidity to determine the human-perceived equivalent temperature.





The “lamp“ of the display field will be color-coded corresponding to the calculated heat index.

| | |
|--|-----------------------------|
|  keine Beeinträchtigung | Hitze-Index < 27 °C |
|  Vorsicht | 27 °C < Hitze-Index ≤ 32 °C |
|  Erhöhte Vorsicht | 32 °C < Hitze-Index ≤ 40 °C |
|  Gefahr | 40 °C < Hitze-Index ≤ 54 °C |
|  Erhöhte Gefahr | Hitze-Index > 54 °C |

Humidex

The Humidex can be set instead of the heat index as an alternative option.

The “lamp“ of the display field will be color-coded corresponding to the calculated humidex.

| | |
|--|-------------------------|
|  keine Beeinträchtigung | Humidex < 30 °C |
|  Leichtes Unbehagen | 30 °C < Humidex ≤ 39 °C |
|  Starkes Unbehagen | 39 °C < Humidex ≤ 45 °C |
|  Starkes Unwohlsein | 45 °C < Humidex ≤ 54 °C |
|  Sehr ernste Gefahr | Humidex > 54 °C |

Remark: The heat index or the Humidex are relevant for temperatures ≥20 °C.



Remark: The heat index or the Humidex can just be calculated if there is the measured relative humidity.

Remark: At temperatures ≤10 °C the wind chill will be calculated and displayed.

Wind chill

The wind chill describes the difference between the measured air temperature and the felt temperature depending on the wind speed. It is defined for temperatures below approx. 10 °C.

The “lamp“ of the display field will be color-coded corresponding to the calculated windchill.

| | |
|--|--|
|  Windchill > -28 °C | |
|  Windchill ≤ -28 °C | → es besteht die Möglichkeit, dass es innerhalb von 30 Minuten oder weniger zu Erfrierungen kommt. |

For temperatures below 20 °C and above 10 °C the “lamp“ is deactivated (black) and the current temperature will be displayed.

In the indicator element a respective headline will be shown in dependency of the displayed value.

At

temperatures ≥20 °C → headline = heat index (or Humidex depending on the configuration)

temperatures below 20 °C or above 10 °C → headline = air temperature

temperaturen ≤10 °C → headline = wind chill

Remark: The wind chill can be calculated based on available measured wind speed.

If there is no relative humidity the “current temperature“ will be displayed instead of the heat index/Humidex and the headline will be changed into “air temperature“. This also applies if there is no wind speed, and the wind chill can't be calculated.

3.4.2.3.4. Dew point (measured or calculated)

The dew point is the temperature at which dew forms and is a measure of atmospheric moisture. It is the temperature to which air must be cooled at constant pressure and water content to reach condensation. The dew point will be issued (e.g. by the EOLOS IND or THP) or can be calculated from the temperature and the measured air humidity.

3.4.2.3.5. Absolute air humidity

The absolute air humidity (AH) or real humidity is the mass of dissolved water in a certain volume of air. It is upwardly limited by the maximum air humidity.

3.4.2.3.6. Air pressure (altitude corrected)

The air pressure can be issued directly or can be corrected in relation to the altitude of the measurement location. Therefore, the altitude of the air pressure sensor (measurement location) has to be inserted and normally the measured temperature and the relative humidity is needed.

If there is no measured temperature and relative humidity the altitude correction will be calculated with the ICAO-standard atmosphere.

According to the ICAO-standard atmosphere the relative air humidity is considered as 0 % (dry air) and the temperature set to 15 °C (288.15 K). Up to 11000 m (m.a.s.l.) the (standard) temperature decreases by -0.0065 K/m.

3.4.2.3.7. Air pressure above sea level - QNH

The measured air pressure can be corrected to sea level. For the simple correction according to QNH the ICAO-standard atmosphere is used. The only requirement is to insert the to be considered height of the air pressure sensor above sea level.

The QNH-calculation takes place with the global mean values in the mean sea-level of the ICAO-standard atmosphere (relative air humidity = 0 % ($e = 0$), temperature = 15 °C).

3.4.2.3.8. Air pressure above sea level - QFF

The QFF calculation takes place under the consideration of the real atmosphere at the measurement site. Therefore, the to be considered height of the air pressure sensor above sea level has to be inserted as well as to be assigned a temperature sensor and a relative humidity sensor.

3.4.2.3.9. Sunshine duration (day)

The display of the sunshine duration takes place in hours minutes (HH:MM). Therefore, over the day (starting at 0 o'clock) the measured status "sun yes/no" will be added up (integrated) and at 24 hours reset again.

3.4.2.3.10. Duration of precipitation (day)

The display of the duration of precipitation takes place equivalent to the sunshine duration. The duration of precipitation takes place in hours and minutes (HH:MM).

Therefore, over the day (starting at 0 o'clock) the measured status "rain yes/no" will be added up (integrated) and at 24 hours reset again.

3.4.2.3.11. Amount of precipitation (day)

The display of the amount of precipitation takes place in mm. Therefore, over the day (starting at 0 o'clock) the measured will be added up over the time (integrated) and at 24 hours reset again.

3.4.2.4. History diagram

The history diagram continuously shows the course of the measured parameters. At a change of day this will be displayed via a vertical line and over the time scale. The values are concentrated to keep the data volume small. The measured value axis adapts itself automatically in the scaling of the actual displayed measured values.

The quantity of the possible history diagrams is limited due to the limited internal memory.

3.4.2.5. Trend display

The trend display is part of the history diagrams and the numerical displays. For the trend calculation the time base has to be adjusted. 10 minutes, 30 minutes, 1 hour and 3 hours can be chosen. If the trend is deactivated, the trend display accordingly won't be displayed. The trend calculation takes places according to the aPPP calculation.

The Trend display knows the following 9 statuses:

| Symbol | Code | Description |
|--------|------|---|
| | 1 | Increasing, then steady; or increasing, then increasing more slowly; atmospheric pressure now higher than three hours ago |
| | 2 | Increasing (steadily or unsteadily); atmospheric pressure now higher than three hours ago |
| | 3 | Decreasing or steady, then increasing; or increasing then increasing more rapidly; atmospheric pressure now higher than three hours ago |
| | 0 | Increasing, then decreasing; atmospheric pressure the same or higher than three hours ago |
| | 4 | Steady; atmospheric pressure the same as three hours ago |
| | 5 | Decreasing, then increasing; atmospheric pressure the same or lower than three hours ago |
| | 6 | Decreasing, then steady; or decreasing, then decreasing more slowly; atmospheric pressure now lower than three hours ago |
| | 7 | Decreasing (steadily or unsteadily); atmospheric pressure now lower than three hours ago |
| | 8 | Steady or increasing, then decreasing; or decreasing then decreasing more rapidly; atmospheric pressure now lower than three hours ago |

The acquisition period for the air pressure tendency is according to WMO 3 hours. The acquisition period can be configured to 10 minutes, 30 minutes, 1 hour or 3 hours.



3.4.2.6. Sector display

The sector display shows graphically the distribution of brightness of the 8 brightness sensor of the LGR. The scaling adapts itself automatically to the current displayed measuring values.

3.4.2.7. Status display

The status display shows the event of a status signal (e.g. "precipitation YES/NO" or "sun YES/NO").

The signalling takes place via the "lamp":

-  Logisch 1 (z.B. Sonne JA)
-  Logisch 0 (z.B. Sonne NEIN)

4. Loading of a stored configuration

As described in chapter 3.1 the configuration of a met[LOG] can be stored under any name. Shall this configuration be loaded again firstly the following line has to be inserted at the end of the corresponding file on the SD card:

```
{"method":"POST","path":"/config/saveconfig"}
```

Remark ! It is important that the file always ends with a new line(<CR> and/or <LF>)!

Then the file must be renamed into \$config.cfg. It is recommended to create at first a copy of the stored configuration for this purpose.

After having restarted the met[LOG] the configuration will be loaded.

Remark ! After having loaded the configuration file correctly it will be deleted from the SD card by the met[LOG] automatically.

In case of having set a password and before having accepted the configuration via SD card the password has to be handed over at the beginning of the config-file:

```
{"method":"POST","path":"/system/access","data":{"PWD":"abc"}}
```

Whereat "abc" has to be replaced by the respective password; e.g.. "1234".

5. Auto configuration

Pressing the button behind the front panel of the met[LOG] the met[LOG] turns into a auto configuration mode. In the first part (e.g. 30 seconds) of the auto configuration the met[LOG] intercepts the lines after talker telegrams.

Remark ! The auto configuration can last up to 8 minutes!

The auto configuration can be deactivated in the menu. Always after having realised an auto configuration it will be deactivated afterwards. But at any time it can be reactivated in the configuration menu.

The recognised parameters will be registered in the sensor list and the log list in the order of the respective COM interfaces (COM 1-3) in the following order:

1. Wind
2. Air temperature
3. Air humidity
4. Air pressure
5. Brightness
6. Sunshine
7. Global radiation
8. Precipitation status
9. Precipitation
10. Precipitation intensity

As a name (sensor designation) the parameter and the consecutive number will be assigned. In the visualisation the parameter of a COM interface will automatically be summed up within a group.

Alarms remain deactivated.

Remark ! During auto configuration all previous configurations (regardless of whether manually or automatically created) will be deleted.

5.1. Talker-Sensors

The talker programs clearly identify the parameter of the connected LAMBRECHT sensors. The recognised telegrams will be chosen (or placed) automatically in the configuration of the COM interfaces.

The unit, the number of the decimal places, the sensor type, the mean value or the trend time will be created correspondingly the following table. Possible virtual values which can be the result of the recognised parameter are also listed in the table.

Table of the auto configurations at known NMEA telegrams

| Protocol | Parameter | Unit | Decimal-places | Sensor-type | Mean value time | Trend time | Virtual value |
|----------------------|-------------------------|------|----------------|-------------|-----------------|------------|--|
| WIMWV | Wind speed | m/s | 0,0 | G | 10 Min. | --- | Vectorial connection with wind direction in the same protocol Wind chill with temperature on the same COM-interface |
| | Wind direction | ° | 0 | R | 10 Min. | --- | Vectorial connection with wind speed in the same protocol |
| WIMTA | Temperature | °C | 0,0 | T | --- | 1 hour | Heat index with rel. humidity on the COM-interfaces Wind chill with wind speed on the same COM-interfaces |
| WIMHU | Rel. air humidity | % rF | 0,0 | H | --- | 1 hour | Heat index with temperature on the same COM-interfaces |
| | Dew point | °C | 0,0 | D | --- | --- | |
| WIMMB | Air pressure | hPa | 0,0 | P | --- | 3 hours | |
| WIXDR (PR) | Amount of precipitation | mm | 0,0 | N | --- | --- | |
| WIXDR (C/H/P) | Temperature | °C | 0,0 | T | --- | 1 hour | Heat index with rel. humidity on the same COM-interfaces Wind chill with wind speed on the same COM-interfaces |
| | Rel. air humidity | % rF | 0,0 | H | --- | 1 hour | Heat index with temperature on the same COM-interfaces |
| | Dew point | °C | 0,0 | D | --- | --- | |
| | Air pressure | hPa | 0,0 | P | --- | 3 hours | |

5.1.1. rain[e]-Talker

The rain[e] talker protocol is a semicolon separated protocol. The values will always be transmitted with a sign. The protocol is described in chapter 9.2.1.

Out of the received protocol will be processed by the met[LOG]:

- The intensity in mm/min
- The total quantity in mm
- The heating status (as standard nor displayed neither stored)
- Internal temperature in °C (as standard nor displayed neither stored)
- The system status (as standard not displayed but stored)

The total quantity indicates the collected precipitation in mm since switching on the device. In case that the total quantity is about to reach the total possible quantity, the quantity will be set at 0 in a time without precipitation. That is the reason why there is no absolute threshold whereby exceeding will be set at 0. For the evaluation of the amount of precipitation the added quantity will be calculated from each received value of the total quantity. In this way measuring values might not get lost if one data telegram might not be received.

The used units, decimal places and sensor types are listed in the following table:

| Protocol | Parameter | Unit | Decimal place | Sensor type |
|----------------|------------------------------|--------|---------------|-------------|
| rain[e] Talker | Intensity of precipitation | mm/min | 0.000 | N |
| | Amount of precipitation | Mm | 0.000 | N |
| | rain[e] heating status | % | 0 | Z |
| | rain[e] internal temperature | °C | 0 | T |
| | rain[e] system status | --- | 0 | Y |
| | | | | |

Heating status, internal temperature, and system status of the rain[e] won't be indicated in the visualisation and won't be written automatically neither in the log list.

6. Alert generation / management

For alert messages or switching tasks the met[LOG] has 4 digital outputs. To these outputs the met[LOG] can switch through the supply voltage in case of alert.

For the alert messages or switching tasks 8 warning channels are available. If needed these can be connected logically (AND/OR) with each other.

Basically, for each output every measured parameter (partially also the virtual values) can be used for a warning. Fails a sensor or a parameter and the met[LOG] recognizes the failure a warning will be triggered either (out will be switched to logical 1).

6.1. Alert configuration

Shall the met[LOG] be used for alert messages of switching tasks firstly the reporting system has to be activated via the button "reporting system".

For each digital output can firstly be set, whether it should be “high“ or “low“ in the normal situation (default situation).

| | | | | |
|------------------------|-----------------------------|-----------------------------|-----------------------------|-----------------------------|
| Meldesystem EIN AUS | Logik Ausgang 1 High Low | Logik Ausgang 2 High Low | Logik Ausgang 3 High Low | Logik Ausgang 4 High Low |
|------------------------|-----------------------------|-----------------------------|-----------------------------|-----------------------------|

If the switch is set to “low“ the corresponding output also remains at logical 0 at “low“ and at logical 1 at “high“.

If the switch is set to “high“ the corresponding output also remains at logical 0 at “high“ and at logical 1 at “low“.

For each warning channel following parameters can be adjusted

- The to be monitored parameter
- Alert threshold:
 - Low level = lower switching threshold
 - High level = upper switching threshold
- Window function or hysteresis function
- Energy and drop-out delay
- Time-dependent warnings (time window with start-time, stop-time, weekdays)
- Duration of a warning

The following diagram shows the configuration possibilities of a warning channel. In total 8 warning channels can be configured.

EIN

AUS

Alarm 2

Parameter auswählen

None

Schaltausgang

| | | | | |
|---|---|---|---|---|
| 1 | 2 | 3 | 4 | X |
|---|---|---|---|---|

Test

0

Low-Pegel

0

High-Pegel

0

Invertierte Logik

EIN

AUS

Verzögerung

0

Verzögerung

0

Hysteres-Funktion

EIN

AUS

AN

Schalter

UND

ODER

AUS

Alarm-Kanal

| | | | | | | | | |
|---|---|---|---|---|---|---|---|---|
| 1 | 2 | 3 | 4 | 5 | 6 | 7 | 8 | X |
|---|---|---|---|---|---|---|---|---|

EIN

AUS

Zeit Einstellungen

Start time

00 : 00

Stop time

00 : 00

Day of the week

Mon

Tue

Wed

Thu

Fri

Sat

Sun

Alarm off

0

The warning channels can be connected logically with each other. Therewith also wind direction depending on warnings can be realized for example.

Via the switch „ON/OFF“ a warning channel can be activated. Deactivated warning channels have the default value logical-0.

In the selection field „to be monitored parameter“ will be chosen from the available parameters that one which has to be monitored in this warning channel. Through the selection of the parameter simultaneously is defined the unit with which the „low level“ and „high level“ are adjusted.

In the field „low level“ will be entered the lower switching threshold beyond which the corresponding warning channel will be set to logical-1.

In the field „high level“ will be entered the upper switching threshold beyond which the corresponding warning channel will be set to logical-0.

Thereby window functions can be realized.

In case of not entering anything in the field „high level“ it will be ignored and just the „low level“ will be considered as a threshold. In case of exceeding the “low level” the corresponding warning channel will be set to logical-1. Will the “low level” be fallen short again than the warning channel will be set back to logical-0.

The thresholds inserted in the fields “low level” and “high level” will be interpreted from the met[LOG] as a twisted full circle clockwise (similar to a wind direction sensor). This means that also such entries are permitted where the value for the “low level” is higher than the value of the “high level”.

Example:

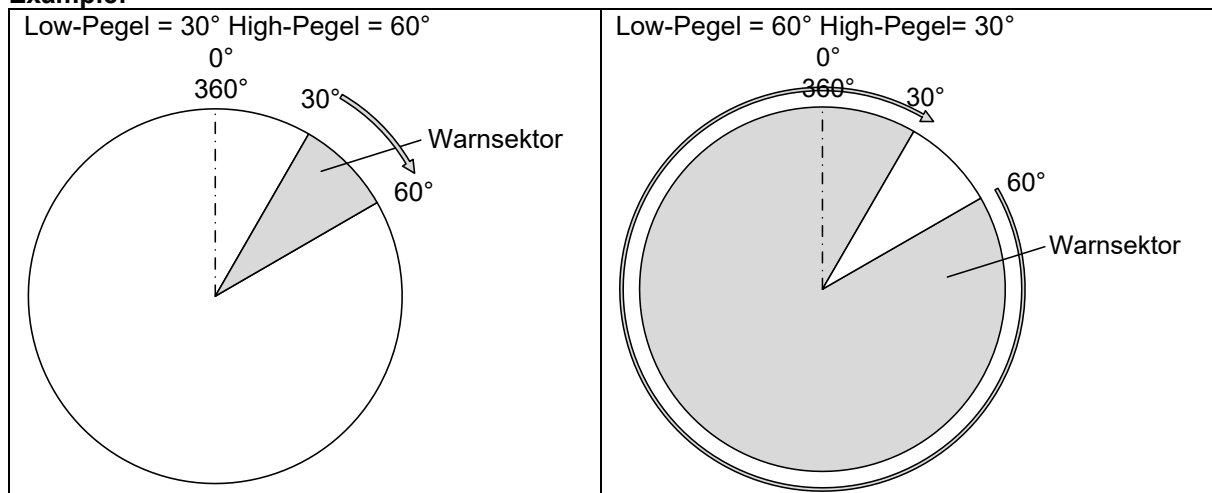

Alternatively, the in the example portrayed inverting can also be realized via the switch “inverted logic”.

With the switch “hysteresis function” the hysteresis function can be activated instead of the window function with the “low level” and the “high level”.

Hysteresis function

At the hysteresis function the warning channel will be set to logical-1 if the measuring value exceeds the “high level”. The warning channel will be logical-0 again when the “low level” will be fallen short .

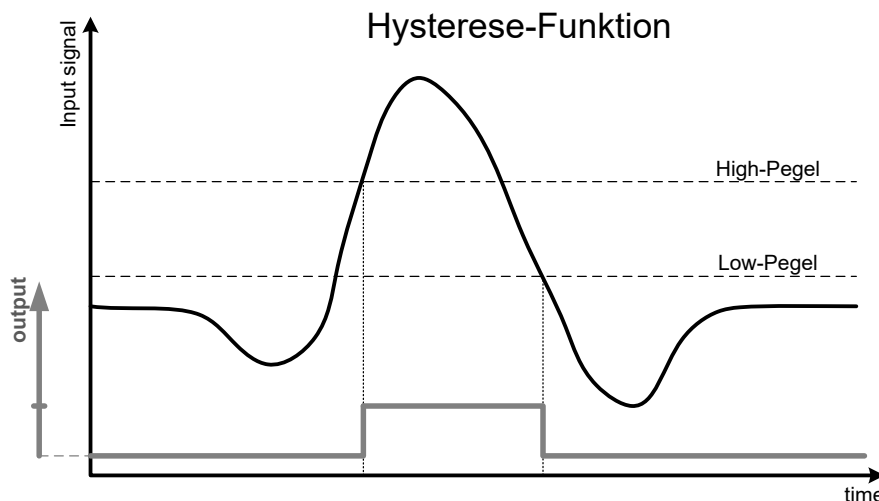

Window function

At the window function the warning channel will be set on logical-1, if the measuring value is between “low level” and “high level”. The warning channel will be logical-0, if the “low level” switching point will fall below or the “high level” switching point will be exceeded.

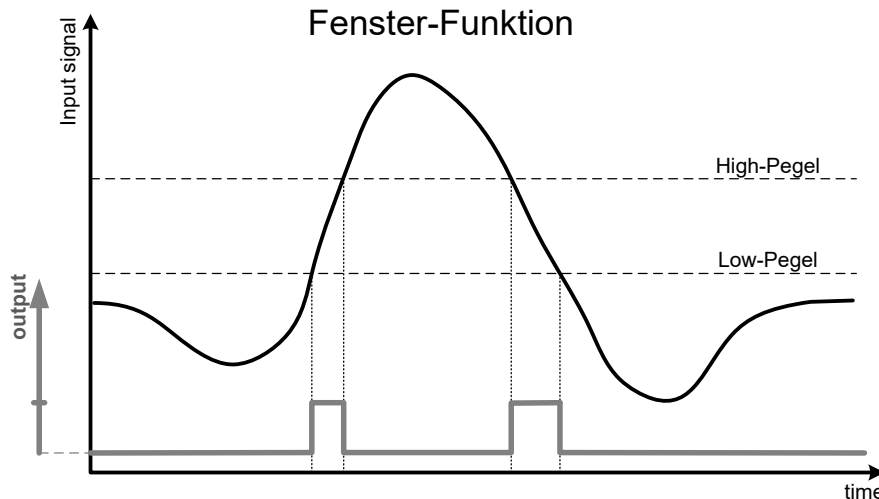

The fields “delay ON“ and “delay OFF“ doesn't have to be filled in necessarily. In the event of not entering a time the delay amounts 0 seconds each time. In case of entering a time (e.g. 5 sec), the monitored parameter has to be exceeded or to be fallen below the specified time before switching the warning channel.

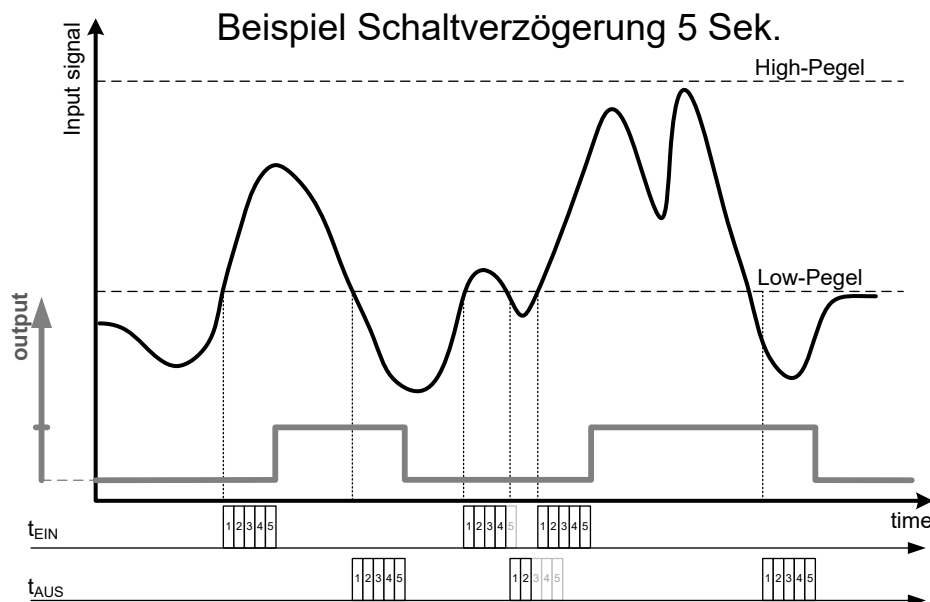

Via the switch “inverted logic” the result of the warning channel can be inverted or negated.

Via the switch “AND/OR” the warning channel can be connected logically with a further warning channel which can be selected in the selection series “warning channel 1-8”. The switch has got 3 states “AND” (on click), “OR” (two clicks) or “OFF” (three clicks). In case of choosing no warning channel the switch “AND/OR” will be ignored.

The default value of the warning channels is logical-0. Is a warning channel connected to a deactivated warning channel the deactivated channel has always the default value logical-0.

To avoid a circular reasoning the warning channel, which is connected via the switch „AND/OR“ to another channel, will be deactivated or greyed out in the configuration field of the other warning channels.

The figure below shows a configuration example for a wind direction independent warning. In the example the warning channel 1 is connected to the warning channel 5 via “AND”. With the selection of the connected channel the channel 5 has been locked for the choice in all the other warning channels.

The screenshot shows the configuration interface for alarm channels. At the top, there are four logic outputs (Logik Ausgang 1-4) with 'High' and 'Low' indicators. Below them are four switch outputs (Schaltausgang 1-4) and a 'Simulation' button set to 'Off'. The main area displays two alarm channels: 'Alarm 1' (0.2 m/s) and 'Alarm 5' (0.2 deg). Each channel has a 'Parameter auswählen' dropdown, a 'Schaltausgang' selection (1-4, X), a 'Test' field (0), 'Low-Pegel' and 'High-Pegel' inputs, 'Verzögerung' (0), 'AN' (UND/ODER) and 'AUS' (Alarm-Kanal) settings, and 'Zeit Einstellungen' (Start time, Stop time, Day of the week, Alarm off).

The result of this connection will be output via the digital output 1 (switch output). The switch output can be chosen in each case out of the selection series “switch output 1-4”. It is possible, that several warning channels use the same switch output. In this case they will quasi be connected via OR.

In a wind channel, which has been connected via the switch “AND/OR“ with a predecessor (in the example above channel 1 is the predecessor of channel 5), the equivalent switch output will be chosen as for the predecessor an AND would be bypassed.

Test function

The functionality of the digital outputs (hardware) and the alarm configuration can be tested via the browser. For this purpose, the page has got a simulation button. Is this in position “ON” the functionality of the hardware switch outputs can be tested via the button “switch output”. When actuating the relevant button, the corresponding switch output will be switched.

The screenshot shows the control panel with 'Schaltausgang' buttons (1-4), a 'Simulation' button set to 'Off', a 'Logiktest' button, and 'Alarm (Test)' buttons (1-4).

Via the button “logic test” in the warning channels adjusted logic can be verified. Therefore, at each warning channel can be inserted test values (see example illustration above). Will the button “logic test” be pressed the logic calculation with the in the field “test parameter” inserted test values will be performed and the respective lamp (1-4) “alarm (test)” of the respective output will be switched accordingly the result. A real switch of the switch outputs does not take place in this test.

Warning amount of precipitation

For a warning at the exceedance of a certain amount of precipitation a period under review can be defined as a sliding window. The met[LOG] calculates the sum of the recorded precipitations in the adjusted time frame and triggers at exceedance accordingly the adjusted alarm.

As a time frame 1-120 minutes can be adjusted. The same warning function is available for status sensors like e.g. rain YES/NO as rain duration and sun YES/NO as sunshine duration. In this case at exceedance of the adjusted duration in the configured time the alarm will be set.

For the instantaneous value sensors will the in the field entered time used as mean value time. Thereby very dynamic signals can be subdued. As possible mean value time are 0 to 600 seconds adjustable.

Remark: For the sum and mean value formation max. 20 buffers with 60 values each are available.

At a one-minute sliding mean value every second a value will be taken and each second the buffer or the mean value will be updated.

At a ten-minute sliding mean value every ten seconds a mean value will be set up out of ten values and be written in the buffer, the earliest ten second mean value will be deleted and out of the buffer a mean value of the ten second mean values will be created.

At a 120-minute sliding mean value every 120 seconds a mean value will be set up out of 120 values and be written in the buffer, the eldest 120 second mean value will be deleted and out of the buffer a mean value of the 120 second mean values will be created.

Time-controlled alerting (e.g. for building technology)

Alarms or control tasks will partially be carried out time based respectively daily based. E.g. shading an office doesn't need to take place during weekends.

To perform this, it is possible to choose timeframe and a day of the week for alerting in a warning channel. Either can this date be connected directly with the "to be monitored parameter" or the time itself is the "to be monitored parameter" and will be connected with AND/OR with the other warning channels.

Additionally, it is possible to finish automatically by entering an "alarm off" time and alerting (switching an output) after the expiry of the set time even though the alarm situation still exists. The switch output will only be switched if before the alarm situation has been removed once again.

7. Data export as a CSV

Stored data can be exported as a CSV-file, performed on a daily basis or else manually via the "Export" function in the "General" menu, and creates a CSV file on the SD card of the met[LOG]. This file can be downloaded to a PC via the "Get file" function in the "General" menu.

Fields can be separated with a comma (English) or a semicolon (German). The decimal place of the values will be separated with a point ".". Will the fields be separated with a semicolon, the decimal place of the values will be separated with a comma ",".

8. Reset

If necessary, the met[LOG] can be reset on the factory setting as follows:

- 1.) Switch of the met[LOG]
- 2.) Keep the front button pressed
- 3.) Switch on again the met[LOG]
- 4.) Keep the front button pressed, until the front LED has blinked three times.
- 5.) Then release the button.

9. Data collection

The met[LOG] understands the following serial data protocols

- NMEA (Talker)
 - **WIMWV**
 - **WIMTA**
 - **WIMMB**
 - **WIMHU**
 - **WIXDR (PR)**
 - **WIXDR (C/H/P)**
- Rain[e] Talker
- Rain[e] SDI-12 auf RS485

The 4 analogue/digital interfaces can measure the following signals:

Voltage, free scalable e.g.:

- 0...10 V
- 0...5 V
- 0...2.5 V
- 0...1 V
- Frequencies
 - via an open collector,
 - 0...192 Hz
 - 0...500 Hz
 - active output, level configurable
- Impulse counter
 - Via an open collector,
 - Active output, level configurable
 - With activatable precipitation correction for LAMBRECHT rain gauges
- Status
 - Via an open collector
 - Active output, level configurable, e.g.:
 - (logical 0 = 0 V and logical 1 = 5 V)

9.1. NMEA-protocol

Following LAMBRECHT sensors are using the NMEA-protocol as a talker:

- EOLOS IND
- EOLOS MET
- WENTO IND
- WENTO MET
- ARCO NAV
- ARCO SERIAL
- THP

9.1.1. Basics NMEA

The NMEA-talker protocol is based on the RS422 interface or rather on the RS485. In talker mode, both interfaces are electrically similar. Therefore, the LAMBRECHT sensors with RS422-NMEA talker interface can be easily connected to the met[LOG].

The NMEA structure allows for one talker and several recipients (listeners) for each COM interface. It is theoretically possible to connect several met[LOG] data in combination with further NMEA listeners (e.g. the LAMBRECHT MeteoLCD) to a NMEA-talk sensor.

NMEA uses the following parameter:

- Baud rate 4800
- Data bits 8 (D7 = 0)
- Parity none
- Stop bits 1

All delivered data will be interpreted as ASCII characters by the met[LOG]. The “most significant bit” of the 8-bit character will always be transmitted as a zero (D7 = 0).

9.1.2. Supported NMEA-telegrams

- **WIMWV**
- **WIMTA**
- **WIMMB**
- **WIMHU**
- **WIXDR (PR)**
- **WIXDR (C/H/P)**

9.1.2.1. Data telegram WIMWV wind direction and wind speed

Example of a data sequence with comma separated fields: \$WIMWV,357.0,R,5.2,M,A*CS<CR><LF>

Field separator: , (comma)

Header: \$WIMWV

Wind direction: (WD) 0.0 to 360.0

R: relative wind direction

Wind speed: (WS) 0.3 to 75.0

M: metric unit in m/s

Status A (valid) / V (not valid)

Telegram end: <CR> <LF>

Error code: WR 999.9

Error code: WG 99.9

9.1.2.2. Data telegram WIMTA air temperature

Example of a data sequence with comma separated fields: \$WIMTA, -25.0, C*CS <CR><LF>

Field separator: , (comma)

Header: \$WIMTA

Temperature: -30.0 to 70.0 C: °C

Telegram end: <CR> <LF>

Error code: 999.9

9.1.2.3. Data telegram WIMMB air pressure

Example of a data sequence with comma separated fields: \$WIMMB, , ,1050.0, B*CS <CR><LF>

Field separator: , (comma)

Header: \$WIMMB

Air pressure 600.0 to 1100.0

B: air pressure in hPa

Telegram end: <CR> <LF>

Error code: 9999.9

9.1.2.4. Data telegram WIMHU relative air humidity

Example of a data sequence with comma separated fields: \$WIMHU,100.0, , -30.0,C*CS<CR><LF>
 Field separator , (comma)
 Header: \$WIMHU
 rel. air humidity: 0.0 to 100.0
 Dew point -30.0 to 70.0
 C: °C
 Telegram end: <CR> <LF>
 Error code: 999.9

9.1.2.5. XDR-Telegrams

The telegram is field-orientated and can have a variable length. The fields are comma separated. Four fields are forming a group. The group starts with the indication of the type (type field) followed by the corresponding measuring value and afterwards the corresponding units and ends with the sensor ID. It must be kept in mind that the order of the groups is random! The XDR telegram can contain different numbers of groups.

9.1.2.5.1. XDR for the issue of the precipitation amount at EOLOS IND / WENTO IND

Example of a data sequence with comma separated fields: \$WIXDR, PR, 0.2, M, 01*CS <CR><LF>
 Field separator: , (comma)
 Header: \$WIXDR
 PR precipitation: Depending on the connected LAMBRECHT precipitation sensor.
 Each impulse increases the value by 0.1. In case of increasing the value 10, the value will be reset to 0.1. The actual amount of precipitation is always the difference between the previous value and the actual value. This applies for rain gauges with a 2ccm³ bucket. The current values of sensors with a 4 cm³ bucket has to be multiplied by 2.
 PR: Sensor type amount of precipitation (proprietary)
 M: Qualifier for amount of precipitation in mm
 01: Transducer ID
 Telegram end: <CR> <LF>

9.1.2.5.2. XDR Telegram format for temperature, humidity and air pressure

XDR for the issue of temperature, humidity, and pressure at EOLOS IND and WENTO IND

\$WIXDR,C,yy.y,C,1,P,x.xxxx,B,1,H,zz.z,P,1,C,yy.y,C,2*CS<CR><LF>
 Field separator: , (comma)
 Header: \$WIXDR
 C: Sensor type temperature
 yy.y: Temperature in °C
 C: Unit: °C
 1: Sensor ID, set to 1
 P: Sensor type "pressure"
 x.xxxx: air pressure-measuring value in bar
 B: Unit: bar
 1: Sensor ID, set to 1
 H: Sensor type humidity
 zz.z relative air humidity in %
 P: Unit: %
 1: Sensor ID, set to 1
 C: Sensor type temperature
 yy.y: temperature in °C
 C: Unit: °C
 2: Sensor ID, ID 2 for dew point-temperature.
 <CR><LF> End character

9.1.2.5.3. NMEA Checksum „CS“

The checksum „CS“ will be displayed as 2-character-hexadecimal value. It is calculated as a XOR operation of all signs of the data set between “\$” and “*”. This means “\$” and “*” will not enter into the calculation.

<CR>...carriage return (hex0D),
 <LF>... linefeed (hex 0A)

9.2. Protocol rain[e]

The rain[e] uses in connection with the met[LOG] two protocols:

- **Talker-Protocol**
- **SDI-12 on RS485**

9.2.1. Talker-Protocol rain[e]

Is the talker-protocol activated the rain[e] sends via the RS485 interface an ASCII-string in a with the rain[e] commander adjustable time interval between 10 and 60 s (standard setting=10 seconds) (see also rain[e] manual).

In the sent ASCII-string are located the measuring values:

- **Intensity in mm/min**
- **Total quantity in mm**
- **Status of the heating (1 = ON, 0 = OFF)**
- **Internal housing temperature in °C**
- **System status**

9.2.2. SDI-12 on RS485 – rain[e]

Alternatively, the communication with the rain[e] can take place via SDI-12 commands. The communication with the help of the SDI-12 protocol takes place deviating from the „SDI-12 A Serial- Digital Interface Standard for Microprocessor-Based Sensors, Version 1.3, 2012“ via the RS485-interface.

With this protocol the following measuring values and data can be called of via the met[LOG]:

- Precipitation intensity of the last-minute mm/min
- Precipitation amount since the last call off mm/m²
- Temperature interior °C
- Heating ON (1) / OFF (0)
- Total heating capacity %
- Error states:
 - Error exceedance of 10 °C at heating ON 0 or 1
 - Error heating 0 or 1
 - Error temperature sensors in the interior 0 or 1
 - Error temperature sensor at the funnel 0 or 1

9.3. Analogue Sensors

For the connection of the analogue sensors are 4 analogue inputs available. The input can measure 0...10 V with 12 bit (16bit ADU). Additionally, the input can be used as digital input. Basically, it is possible to connect the sensors with an active status signal (voltage). It is also possible to connect sensors with an open collector (OC) or a switch contact (relay) for which, depending on the configuration, the supply voltage can be switched as a “switching voltage” on the digital inputs.

Moreover, the met[LOG] has got the possibility to measure temperatures with the help of a NTC.

9.3.1. Sensors with voltage output

The sensors with voltage output will be measured and stored according to their scaling.

9.3.2. Sensors with a status output

Sensors with a status output can be e.g. a rain detector (rain yes/no) or a sunshine duration sensor (sun yes/no).

Normally the sensors deliver the status as an OC, a switch contact and/or as an active voltage signal (e.g. no (0) = 0 V and yes (1) = 5 V) (the thresholds can be configured correspondingly).

9.3.3. Sensors with frequency output

Sensors with a frequency output are normally wind speed sensors (e.g. BASIC). The sensors deliver the frequency normally as an OC (e.g. BASIC), as a switch contact and/or as an active voltage signal.

9.3.4. Rain gauges with pulse output

Rain gauges normally deliver the pulses via a switch contact or an OC.

9.3.4.1. Rain gauges with pulse output - debouncing

As the generated pulse signal due to the mechanical structure normally bounces, inside the met[LOG] a debouncing for the digital inputs can be activated. Thereby the number of the permitted impulses per second is limited to a maximum of 3 per second (3Hz).

9.3.4.2. Rain gauges with pulse output - linearization

Rain gauges with tipping bucket in general have an intensity-dependent error measuring the amount of precipitation. This also applies to the LAMBRECHT sensors 15189, 15188 and 1518H3. For these sensors an intensity correction per digital input can be activated inside the met[LOG].

9.3.5. NTC-temperature-sensors

For a temperature measurement an NTC-temperature sensor can be connected. For the best possible measuring result the use of the LAMBRECHT NTC-temperature sensor is recommended (tolerance: ± 0.2 °C at 25 °C, resistance: 10 kOhm at 25 °C).

10. Data storage

The met[LOG] can collect the measured values of the connected sensors and store them each 1-, 2-, 5- or 10 minutes on the SD-card.

10.1. General

Available parameters can be stored the following values:

| Parameter | Values to be stored |
|--|--|
| Wind speed Temperature Humidity Pressure Global radiation Brightness Precipitation intensity | <ul style="list-style-type: none"> ▪ Mean value (scalar) ▪ Minimum value ▪ Maximum value |
| Wind direction | <ul style="list-style-type: none"> ▪ Mean value (vectorial) ▪ Minimum value ▪ Maximum value |
| Wind speed and direction | <ul style="list-style-type: none"> ▪ Mean value (vectorial) ▪ Minimum wind peak ▪ Maximum wind peak |
| Wind peak | <ul style="list-style-type: none"> ▪ Wind direction and wind speed at the moment of the highest wind speed |
| Amount of precipitation | <ul style="list-style-type: none"> ▪ Sum per saving interval |
| Precipitation yes / no sunshine yes / no | <ul style="list-style-type: none"> ▪ Percentage of the storage interval for „yes“ (no = 0 %, yes = 100 % and averaging) ▪ Duration of the event in minutes |
| System status | <ul style="list-style-type: none"> ▪ Just the last received value will be stored per storage interval |

Wind direction

The mean value will NOT be calculated scalar due to the discontinuity of the wind direction between 0° and 360° but has to be calculated vectorially due to the full circle (vectorial means value with unit vectors).

Wind speed and wind direction vectorially connected

For alternative measurements of wind speed and direction, the vectorial mean value of the wind direction and the wind speed will be stored upon configuration.

Wind peak

Wind peak can be stored for wind speed and wind direction measurements. The wind peak indicates the wind direction and wind speed at the time of the highest wind speed each storage interval.

Pressure

The air pressure can be stored as a direct measuring value or as a corrected value.

Amount of precipitation

The amount of precipitation will be stored as a sum of the measured quantity of the respective storage interval.

Status

Typical status information is “rain yes/no“ or “sunshine yes/no“. The status or will be stored as a percentage of the storage interval for the event “yes“ (no = 0 %, yes = 100 % and averaging) or the duration of the appearance for each storage interval in minutes.

System status

Some sensors deliver a system status with error information or similar. The system status will not be condensed, the last valid system status for each storage interval will be stored.

11. Annex

12. Data communication met[LOG] by HTTP

12.1. Identification of the logger

The data communication takes place exclusively via HTTP via the LAN interface.

The identification of the logger and the channel assignment takes place via the call of the web page „statdef.htm“

The page „statdef.htm“ has got the following structure:

```
<HTML>
<HEAD><meta http-equiv="Content-Type" content="text/html; charset=iso-8859-1">
<TITLE>statdef</TITLE>
</HEAD>
<BODY>
<PRE> ..... </PRE>
</BODY>
</HTML>
```

As a block **<PRE> </PRE>** will the data be transferred:

- Station name
- Number of the transferring sensors (incl. virtual sensors)
- Date (hh:mm:ss,yyyy.mm.dd)
- Sensor name 1
- Unit 1
- Decimal places 1
- Sensor type 1
-
- Sensor name n
- Unit n
- Decimal places n
- Sensor type n

Die fields are separated by a comma!

Following coding will be used for the sensor type:

| | |
|---|--------------------------------|
| 0: "A" = "A_____" | 17: "R" = "Wind direction" |
| 1: "B" = "Battery data" | 18: "S" = "Radiation" |
| 2: "C" = "Ceiling" | 19: "T" = "Temperature" |
| 3: "D" = "Dew point" | 20: "U" = "Voltage" |
| 4: "E" = "Evaporation" | 21: "V" = "Visibility" |
| 5: "F" = "Free scale" | 22: "W" = "Resistor" |
| 6: "G" = "Wind speed" | 23: "X" = "Leaf wetness" |
| 7: "H" = "Humidity" | 24: "Y" = "Others" |
| 8: "I" = "Current" | 25: "Z" = "State" |
| 9: "J" = "Solar data (charging voltage,..)" | 26: Sun shine (Z) |
| 10: "K" = "K_____" | 27: Brightness (S) |
| 11: "L" = "Frequency" | 28: Precipitation amount (N) |
| 12: "M" = "M_____" | 29: Precipitation status (Z) |
| 13: "N" = "Precipitation" | 30: Precipitation intensity(N) |
| 14: "O" = "O_____" | 31: Global radiation (S) |
| 15: "P" = "Pressure" | 37: System Status |
| 16: "Q" = "Q_____" | |

12.2. Access to the instantaneous values

The access to the instantaneous values takes places via the call of the page:
“momview.htm”.

It has got the following structure:

```
<HTML>
<HEAD><meta http-equiv="Content-Type" content="text/html; charset=iso-8859-1">
<TITLE>momview</TITLE>
</HEAD>
<BODY>
<PRE>11.10.2011, 17:03:39,01,00, 227.0, 4.8, 14.0,9999.0, 95.9, 13.3, 988.3, 0.0</PRE>
</BODY>
</HTML>
```

As a block **<PRE> ... </PRE>** following data will be transferred:

- Date
- Time
- Measuring value 1
-
- Measuring value n

Die fields are separated by a comma!

The order of the measuring values corresponds to the order of the page “statdef.htm”

12.3. Access to sliding wind data

Access to the sliding wind data is via the call off of the following page:
 „windview.htm“.

It has the following structure:

```
<HTML>
<HEAD><meta http-equiv="Content-Type" content="text/html; charset=iso-8859-1">
<TITLE>windview</TITLE>
</HEAD>
<BODY>
<PRE>11.10.2011, 17:03:39,1,135.0,100.0, 211.0, 135.0,100.0, 211.0, 2,1.8, 0.8,2.7,
1.8,0.8,2.7</PRE>
</BODY>
</HTML>
```

As a block **<PRE> ... </PRE>** following data will be transferred:

- Date
- Time
- Sensor position in sequence out of „statdef.htm“
- Wind direction mean value
- Wind direction start segment (in clockwise direction)
- Wind direction end segment (in clockwise direction)
- Wind direction mean value
- Wind direction start segment (in clockwise direction)
- Wind direction end segment (in clockwise direction)

- Sensor position in sequence out of „statdef.htm“
- Wind speed mean value
- Wind speed start segment (in clockwise direction)
- Wind speed end segment (in clockwise direction)
- Wind speed mean value
- Wind speed start segment (in clockwise direction)
- Wind speed end segment (in clockwise direction)

The fields are separated by a comma!

The order of the measuring values corresponds to the order of the page “statdef.htm“
 Every wind sensor delivers 7 values. Because of compatibility reasons are “mean value”, “start segment” and “end segment” twice.

The met[LOG] calculates the sliding average either for 2 minutes or for 10 minutes.
 The time base for the sliding average can be configured in the “General Settings”.

12.4. Storage format

Determined mean values and extreme values will be stored in a ring memory.

The memory collects the data of one year. The averaging times (= storage intervals) can be 1, 2, 5, 10 minutes.

The data will be stored in the binary format IEEE Real 4 Byte (float). Data files are generated on a daily basis, with the filename YYYYMMDD.BIN

For the filename will be used the following convention:

| | |
|-----------|-----------|
| YYYY year | e.g. 2021 |
| MM month | e.g. 05 |
| DD day | e.g. 06 |

Data sets have the following structure:

uLong Date and time in UNIX-format

Whereby the stored time corresponds to the local time (depending on configured time zone).

Float measuring value 1 mean value or sum

Float measuring value 1 Minimum

Float measuring value 1 Maximum

Word sensorID 1

....

Float measuring value n mean value or sum

Float measuring value n Minimum

Float measuring value n Maximum

Word sensorID 1

If there is no measuring value noValue = 65535 has to be transmitted as a measuring value. Otherwise, the error codes (see NMEA) of the respective sensors will be stored.

The order of the measuring values corresponds to the order of the HTML-page „statdef.htm“. This helps to identify the logger and the channel assignment.

The access to the data takes place via HTTP GetFile.

Example: The page <http://123.456.789.111/f/bin/20170127.bin> delivers the data from the 2017-01-27. (Note: The IP-address has to be replaced by the address of the requested met[LOG].)

12.4.1. Formulas / Calculations

12.4.2. Annex – formula heating index

The heating index (hi) is calculated according to the following formula:

$$hi = c1 + c2 \cdot T + c3 \cdot p + c4 \cdot T \cdot p + c5 \cdot T^2 + c6 \cdot p^2 + c7 \cdot p \cdot T^2 + c8 \cdot T \cdot p^2 + c9 \cdot T^2 \cdot p^2$$

with

T=Temperature in °C

p=rel. humidity in %rH

c1 = -8.784695,

c2 = 1.61139411,

c3 = 2.338549,

c4 = -0.14611605,

c5 = -1.2308094e-2,

c6 = -1.6424828e-2,

c7 = 2.211732e-3,

c8 = 7.2546e-4,

c9 = -3.582e-6

12.4.3. Annex – additional information regarding the heating index

Remark:

At increased temperatures, keep away from the heat!!

Ozone levels can be elevated in this case!

Index: 27-32

States of exhaustion are possible at longer duration and/or physical activities

- avoid midday heat -

Index: 32-41

Sunstrokes, muscle cramps, heat exhaustion are possible at longer duration and/or physical activities

-avoid midday heat -

Index: 41-54

Sunstrokes, muscle cramps, heat exhaustion probable, heat-stroke possible at longer duration and/or physical activities

-avoid heat in general/attention-

Index: 54 and higher

Sunstroke or heat-stroke probable

12.4.4. Annex – formula Humidex

The Humidex (hx) is calculated as follows:

$$hx = T + (3.39556) \cdot e^{[19.8336 - 5417.75/(D+273.15)]} - 5.5556$$

with

T = Temperature in °C

D = Dew point in °C

12.4.5. Annex – formula wind chill

The wind chill (T_{wc}) is calculated as follows:

$$T_{wc} = 13.12 + 0.6215 \cdot T - 11.37 \cdot V_w^{(0.16)} + 0.3965 \cdot T \cdot V_w^{(0.16)}$$

Thereby:

T_{wc} = Wind chill-temperature (in °C)

T = real temperature (in °C)

V_w = Wind speed in km/h

The wind speed should be between 4.8 and 177 km/h (1.3 m/s to 50 m/s).

The temperature should be between –50 and 10 °C.

(This new formula is used from the NOAA since the 01.11.2011).

12.4.6. Annex – formula dew point

The dew point (DT) is calculated as follows:

$$DT = c_3 \cdot \ln(0,01 \cdot RH \cdot SVP(TT)/c_1) / (c_2 - \ln(0,01 \cdot RH \cdot SVP(TT)/c_1))$$

Thereby

DT = Dew point temperature in °C

RH = relative humidity in %

SVP(TT) = Saturation vapour pressure in mbar over water at the air temperature TT in °C

$SVP(TT) = c_1 \cdot e^{(c_2 \cdot TT / (c_3 + TT))}$

TT = Air temperature in °C

ln() = Natural logarithm

Inserted in DT results:

$$DT = c_3 \cdot \ln(0,01 \cdot RH \cdot c_1 \cdot e^{(c_2 \cdot TT / (c_3 + TT))} / c_1) / (c_2 - \ln(0,01 \cdot RH \cdot c_1 \cdot e^{(c_2 \cdot TT / (c_3 + TT))} / c_1))$$

The constants c₁, c₂, c₃ depend on the temperature TT

| Temperature in °C | c ₁ | c ₂ | c ₃ |
|-------------------|----------------|----------------|----------------|
| -50,9 ≤ TT < 0,0 | 6,10780 | 17,84362 | 245,425 |
| 0,0 ≤ TT ≤ 100,9 | 6,10780 | 17,08085 | 234,175 |

12.4.7. Annex – formula absolute air humidity

The absolute air humidity (AH) or real air humidity is calculated as follows:

$$AH = SAH \cdot RH$$

AH = Absolute air humidity
RH = relative air humidity in %

$$SAH = 10^9 \cdot SVP / (CV \cdot RVAP \cdot (TT + 273,15))$$

SAH = maximum absolute air humidity in g steam pro 1 m³ air (g/m³)
SVP(TT) = saturation vapour pressure in mbar over water at the air temperature TT in °C
CV = factor of compressibility for steam; CV can be calculated approximately as follows:

| Temperature in °C | CV |
|-------------------|---|
| -50,9 ≤ TT < 0,0 | $1 - 2 \cdot 10^{(-5)} \cdot (0,1 \cdot (TT + 60) - 1)^2$ |
| 0,0 ≤ TT ≤ 100,9 | $1 - 10^{(-4)} \cdot ((0,1 \cdot TT + 1)^2 + 4)$ |

RVAP = Universal gas constant for steam
RAVP = 4,6151 · 10² Nm/(kg °C)
TT = air temperature in °C

$$SVP(TT) = c1 \cdot e^{(c2 \cdot TT / (c3 + TT))}$$

The constants c1, c2, c3 see table under “dew point calculation“.

12.4.8. Annex – formula air pressure altitude correction

The altitude correction is calculated as follows:

$$QFE = B_n \cdot 2,7182183^{(H_F \cdot 0,03416356 / (T + e \cdot C_h + (H_F \cdot 0,00325)))}$$

thereby

B_n = measured air pressure

QFE = corrected air pressure from the measuring point to the reference plane

H_F = altitude difference to the measuring point in m

T = 273,15 K + t (with t = air temperature in °C)

C_h = Constant 0.12 K/hPa

e = steam pressure at station altitude (hPa)

e = SVP(TT) · RH

with

RH = relative air humidity in %

SVP(TT) = saturation vapour pressure in mbar over water at the air temperature TT in °C, SVP(TT) formula see dew point

In case measured temperature and rel. humidity are not available, they can be calculated with the ICAO-standard atmosphere. (This should also be configurable)

According to the ICAO-standard atmosphere, the rel. air humidity will be considered 0 % (dry air) and the temperature will be set to 15 °C (288.15 K). Up to 11,000 m (above sea level), the standard temperature decreases by -0.0065 K/m.

12.4.9. Annex – formula air pressure over sea level QNH

The QNH-calculation is done with the global mean value at the normal sea level (NHN) of the ICAO-standard atmosphere (rel. air humidity = 0 % (e=0), temperature = 15 °C).

Thus, following formula applies for QNH:

$$QNH = B_n \cdot 2,7182183^{(H_B \cdot 0,03416356 / (288,15 + e \cdot C_h + (H_B \cdot 0,00325)))}$$

whereby

B_n = measured air pressure

QNH = corrected air pressure from the measuring point to the sea level at standard atmosphere

H_B = altitude difference measuring point to the sea level in m

$T = 273.15 \text{ K} + t$ (with t =air temperature in °C)

C_h = Constant 0.12 K/hPa

e = steam at station height (hPa)

$e = \text{SVP}(TT) \cdot \text{RH}$

with

RH = relative air humidity in %

SVP(TT) = saturation vapour pressure in mbar over water at the air temperature TT in °C, SVP(TT)

formula see dew point

12.4.10. Annex – formula air pressure over sea level QFF

The QFF-calculation takes place under consideration of the real atmosphere at the measuring point.

$$\text{QFF} = B_n \cdot 2,7182183^{(H_B \cdot 0,03416356 / (T + e \cdot C_h + (H_B \cdot 0,00325)))}$$

whereby

B_n = measured air pressure

QFF = corrected air pressure from the measuring point to the sea level at the atmosphere at the measuring point

H_B = altitude difference measuring point to the sea level in m

$T = 273.15 \text{ K} + t$ (with t =air temperature in °C)

C_h = Constant 0.12 K/hPa

e = steam at station height (hPa)

$e = \text{SVP}(TT) \cdot \text{RH}$

with

RH=relative air humidity in %

SVP(TT) = saturation vapour pressure in mbar over water at the air temperature TT in °C, SVP(TT)

formula see dew point

13. Modification history

| | |
|------------|--|
| 29.02.2016 | Circuit diagram updated, corr. smaller spelling mistakes |
| 24.05.2016 | New layout |
| 12.10.2016 | Correction of formula for calculation of "maximum absolute air humidity" |
| 07.03.2017 | Chap. 12 "Data communication met[LOG] [...]" updated. |
| 19.12.2018 | Wiring diagram for COM1 and COM2 changed. |
| 14.05.2020 | New Ident-No. 00.95800.010000 |
| 10.02.2022 | Connection diagrams exchanged; chapter "Disposal" added, new product photo |
| | |

14. Warranty

Please note the loss of warranty and non-liability by unauthorised manipulation of the system. You need a written permission from LAMBRECHT meteo GmbH for changes of system components. These activities must be operated by a qualified technician.

The warranty does not cover:

1. Mechanical damages caused by external impacts (e. g. icefall, rockfall, vandalism).
2. Impacts or damages caused by over-voltages or electromagnetic fields which are beyond the standards and specifications in the technical data.
3. Damages caused by improper handling, e. g. by wrong tools, incorrect installation, incorrect electrical installation (false polarity) etc.
4. Damages which are caused by using the device beyond the specified operation conditions.

15. Disposal

LAMBRECHT meteo GmbH is listed and registered at the Stiftung Elektro-Altgeräte Register ear under:

In the category of monitoring and control instruments, device type: "Monitoring and control instruments for exclusively commercial use".

Within the EU



The device has to be disposed according to the European Directives 2002/96/EC and 2003/108/EC (Waste Electrical and Electronic Equipment). Do not dispose the old device in the household waste! For an environmentally friendly recycling and disposal of your old device, contact a certified disposal company for electronic waste.

Outside the EU

Please follow the regulations in your country regarding the appropriate disposal of waste electronic equipment.

Subject to change without notice.
Manual_metLOG.doc 25.22

LAMBRECHT meteo GmbH
Friedländer Weg 65-67
37085 Göttingen
Germany

Tel +49-(0)551-4958-0
Fax +49-(0)551-4958-312
E-Mail info@lambrecht.net
Internet www.lambrecht.net