

User Manual

Lufft CHM 8k Ceilometer

passion for precision · passion pour la précision · pasión por la precisión · passione per la precisione · a passion for

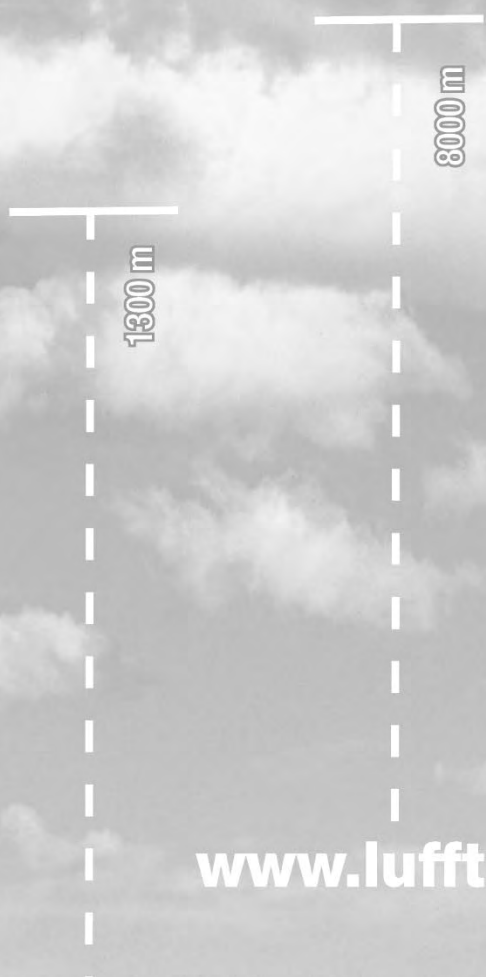

www.lufft.com



Contents

1	General Information	4
2	Safety	5
2.1	Standards and Directives	5
2.2	Safety instructions for the laser system	5
2.3	Requirements for the personnel	5
2.4	Safety instructions for transport, installation, commissioning and cleaning	5
2.5	Description of the notes and symbols	6
2.5.1	Description of warning symbols	6
2.5.2	Description of precautionary statements	6
2.5.3	Symbols used	6
2.6	Product labeling CHM 8k	7
2.7	Designated use	8
3	Technical Data	9
3.1	Ordering information	9
3.2	Technical data	9
4	Technical Description	12
4.1	Construction of the CHM 8k	12
4.2	Functional units of the inner housing	13
4.2.1	Functional diagram	13
4.2.2	Function control and device status	14
5	Transport / Scope of Delivery	15
6	Installation	16
6.1	Installing the CHM 8k	16
6.1.1	Preparatory work	16
6.1.2	Installing on the foundation	17
6.2	Electrical installation	19
7	Commissioning and Decommissioning	23
7.1	Starting up with the RS485 connection	23
7.2	Starting up with the LAN connection	24
7.3	Shutdown	25
7.4	Disposal	25
8	Communication via RS485 & Ethernet	26
8.1	List of configurable parameters	26
8.2	Device configuration with RS485	31
8.2.1	Reading out a parameter	31
8.2.2	Setting a parameter	31
8.2.3	Changing the baud rate	32
8.2.4	Restarting the embedded Linux system / factory settings	33
8.2.5	Changing the time settings	33
8.3	Data query RS485	33
8.3.1	Polling mode	34
8.3.2	Automatic output mode	34
8.3.3	Standard data telegram	34
8.3.4	Extended data telegram	36
8.3.5	Raw data telegram	39
8.3.6	Additional data telegrams	40

8.4	Structure of the NetCDF format	40
8.4.1	General	40
8.4.2	Basic principles	41
8.4.3	File names.....	41
8.4.4	Format structure.....	41
8.4.5	Special values of the evaluation parameters.....	44
8.5	Status code	45
8.5.1	Escalated status codes	46
8.6	Firmware update	49
8.7	Communication via the web interface (Ethernet).....	50
8.7.1	Device overview and access rights (Device tab)	50
8.7.2	Access to measurement data (NetCDF files, viewer).....	50
8.7.3	Configuring the CHM 8k (Config tab)	51
8.7.4	Status and error messages (process status).....	54
8.7.5	Time server	56
8.8	AFD mode	57
8.9	Telegram via Ethernet.....	58
8.10	NetCDF file tools.....	58
9	Data Evaluation / Sky Condition Algorithm (SCA)	59
9.1	Laser remote sensing.....	59
9.2	Preparation of the measured data	59
9.3	Cloud ceilings / cloud base heights	60
9.4	Cloud penetration depths	60
9.5	Parameters for data evaluation.....	61
9.6	Determination of the maximum detection range (MXD).....	61
9.7	Vertical optical visibility (VOR).....	61
9.8	Precipitation and fog	61
9.9	Mixing layer height	62
9.10	Cloud cover (BCC / TCC)	62
9.11	Sky Condition Index (SCI).....	64
10	Cleaning, Maintenance and Service Instructions	65
10.1	Cleaning	65
10.2	Maintenance intervals and measures	67
11	Appendix.....	69
11.1	CHM 8k device hardware version	69
11.2	CHM 8k firmware version	69

1 General Information



This operating manual is part of the equipment. It must always be kept close to the equipment so that it can be accessed quickly when needed.

This operating manual must be read, understood and observed in all respects by all persons responsible for the equipment and all persons who work on it. This applies, in particular, to the chapter "Safety".

Editorial deadline: March 2022

Documentation number: 8349.MEP

This operating manual is valid for the following versions of the equipment with the order numbers:

8349.01-010	8349.02-010
8349.11-010	8349.12-010
8349.11-003	8349.22-010
8349.21-010	8349.32-010
8349.31-010	

The description of the DSL modem is given in a separate supplementary sheet.

Manufacturer

OTT HydroMet Fellbach GmbH
Gutenbergstraße 20
70736 Fellbach, Germany

Telefon +49 711 518 22 – 831

E-Mail met-service@otthydromet.com

Date	Issue	Notes
October 2019	R1.6	Revision chapter 10, technical data, safety advise, and adaptation to new firmware
September 2020	R1.8	Adaptation to new firmware
February 2021	R2.0	Revision, adaptation to new firmware 1.070/1.080 and address change
March 2022	R2.1	Revision, adaptation to <ul style="list-style-type: none">- new firmware 1.090/1.100/1.110- new hardware revisions- max length of test parameter and RS485 example added- using individual telegramformat.xml file- downgrade firmware no longer available- technical data update

Copyright

© 2021

This manual is protected by copyright. No part of this manual may be reproduced in any form (photograph, photocopy, microfilm or any other method) or processed, duplicated or distributed using electronic systems without the written permission of OTT HydroMet Fellbach GmbH. Violations will be prosecuted. The manual was prepared with due care. No liability is assumed for damages resulting from failure to observe the information contained in the manual.

2 Safety

2.1 Standards and Directives

The device is designed according to the recognized rules of technology and safety and is manufactured in series unchanged. The applied rules are listed in the currently valid declaration of conformity. Declarations of conformity can be downloaded from our homepage:

<https://www.lufft.com/products/cloud-height-snow-depth-sensors-288/lufft-ceilometer-chm8k-2405/>

In Europe, the declaration of conformity is enclosed in the accompanying documents.

2.2 Safety instructions for the laser system

The CHM 8k Ceilometer is classified as a Class 1M laser product according to IEC 60825-1:2014-05. It complies with 21 CFR 1040.10 except for deviations pursuant to Laser Notice No. 50, dated June 24, 2007. The sensor emits a beam of invisible laser radiation (905 nm) with small divergence (< 1.5 mrad) and a beam diameter of 60 mm (FWHM). A warning label is attached to the front of the instrument (see section 2.6).

Class 1M radiation is regarded safe except when viewed with telescope optics. The instrument may only be operated in a protected outside area. The following precautions must be taken when operating the sensor:

- Never view the laser beam with optical instruments, especially binoculars
- Avoid looking directly into the laser beam
- Do not operate the instrument with the inner sensor door open
- Do not operate the sensor horizontally (maximum tilt angle 20°)
- Keep the beam path free of reflecting materials

The laser radiation emitted by the sensor is generated by an embedded Class 3B laser module. Even short exposure to Class 3B laser radiation can lead to injuries to the eye and skin. Maintenance and service of the sensor may only be carried out by trained personnel. Under no circumstances may the laser module be removed from the measuring unit or any protective covers removed!

2.3 Requirements for the personnel

- The CHM 8k may only be installed and commissioned by trained personnel who have received instructions in safety-related matters. Electrical connection of the device may only be carried out by a qualified electrician.
- Maintenance and adjustment work on the CHM 8k may only be carried out by the service staff of OTT HydroMet Fellbach GmbH or by the customer's authorized and trained personnel. All maintenance work requires a technical qualification in electrical safety.
- Every person assigned to install and commission the CHM 8k must have read and understood the complete user manual.
- During all work on the equipment, personnel must not be overtired and must not be under the influence of alcohol, medicines or intoxicants. The personnel must have no physical limitations that temporarily or permanently restrict their attention and judgment.





2.4 Safety instructions for transport, installation, commissioning and cleaning

- The CHM 8k may only be loaded and transported in the packed condition and in the transport position (see Figure 5) using suitable lifting gear and transport equipment.
- Inside the shipping container/truck the CHM 8k must be adequately protected against slipping, shock, or other mechanical impacts, e.g. by using straps.
- If the CHM 8k is not installed immediately, it must be stored protected from external influences and adequately secured.
- At least two people are required to install the CHM 8k.
- Once the CHM 8k has been installed, it must be checked. Make sure that no safety-related changes have taken place on the device.
- The inner housing door may only be opened by the service staff of OTT HydroMet Fellbach GmbH or by the customer's authorized and trained personnel.
- Never operate the sensor if a cover window is broken. Return the sensor to OTT HydroMet Fellbach GmbH for repair.



- Explosion hazard. Do not install the CHM 8k in hazardous locations.

2.5 Description of the notes and symbols



2.5.1 Description of warning symbols

Symbol	Use
	Warning of a general hazard
	Warning of laser beam
	Warning of dangerous electrical voltage
	Warning of hot surface
	Electrical equipment marked with this symbol may not be disposed of in European domestic or public disposal systems. Return old or end-of-life equipment to the manufacturer for disposal at no charge to the user.

2.5.2 Description of precautionary statements

 WARNING
Indicates a hazardous situation that, if not avoided, could result in death or serious injury.
 CAUTION
Indicates a hazardous situation that, if not avoided, could result in minor or moderate injury.
NOTICE
Indicates a situation which, if not avoided, may cause damage to the instrument. Information that requires special emphasis.

2.5.3 Symbols used

-  Remarks for the smooth use of the equipment
-  Required action step

2.6 Product labeling CHM 8k

The product labels are shown in Figure 1. The type plate and the protective earth connection are located on the back of the housing foot.

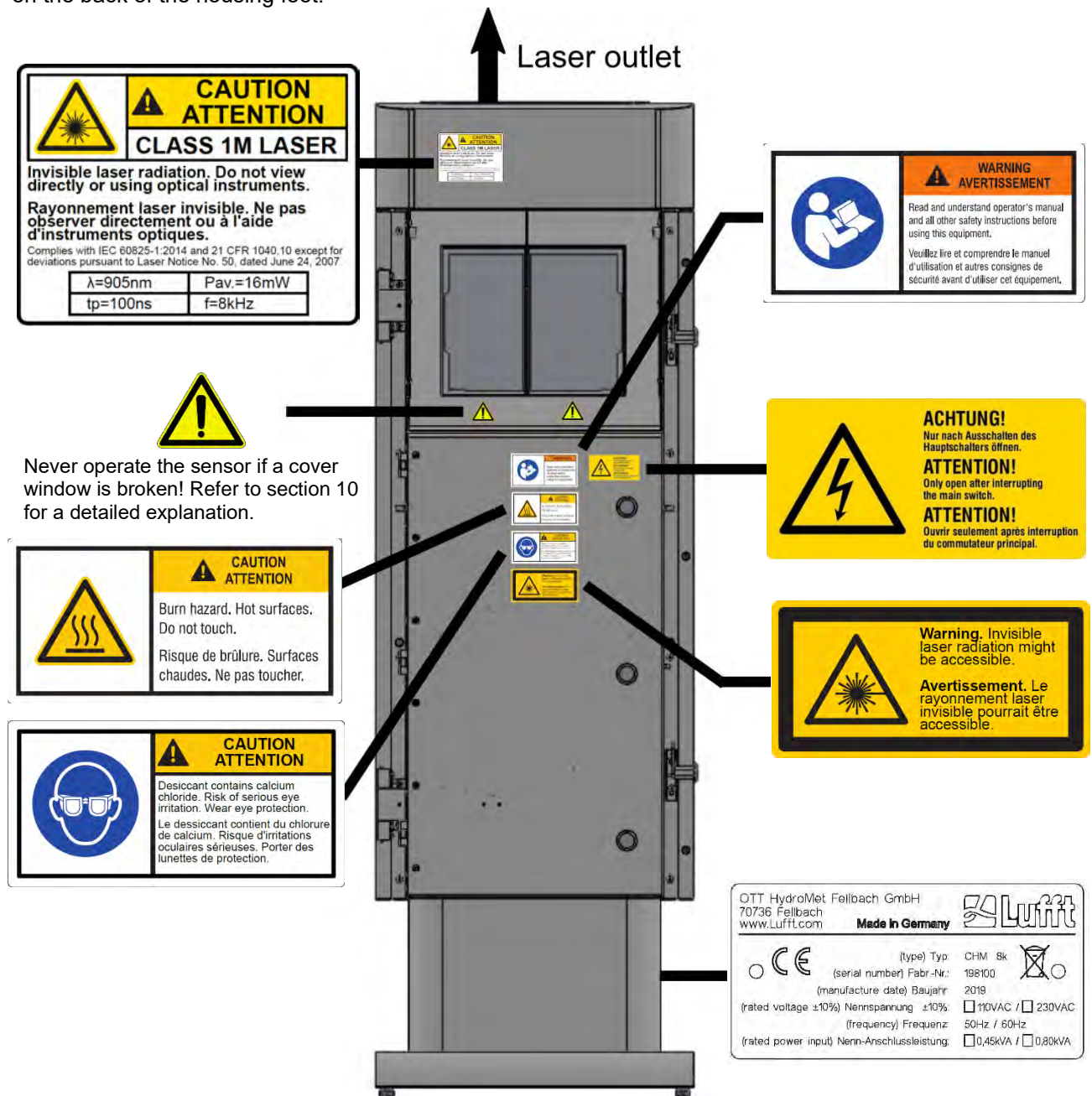

Figure 1 Safety labeling.

2.7 Designated use

The operational safety of the CHM 8k is only guaranteed if used as designated in accordance with the instructions in this operating manual.

The device is designed for single phase operation on a public low-voltage network in accordance with IEC38, 6th edition, 1983.

The ceilometer may be used only in a protected outside area. In standard operation, the laser beam is aligned to the zenith, i.e. the device measures vertically. It can be tilted with adequate accessories to a maximum tilt angle of 20°. Any use beyond this limit is considered non-designated use! The operator bears sole responsibility for any resulting damage.

Horizontal use represents a safety risk for third parties and is expressly excluded.

For trouble-free operation, follow a regular cleaning and maintenance cycle (see chapter 10).

Unauthorized modifications to the device are not permitted and will immediately void all warranty claims. In such cases, no liability whatsoever is accepted for consequential damage.

3 Technical Data

3.1 Ordering information

Equipment Versions			
Order number	Description	Power supply	Cable length
8349.01-010	CHM 8k EU Basic	230 VAC \pm 10%	10 m
8349.11-010	CHM 8k EU + DSL Modem	230 VAC \pm 10%	10 m
8349.11-003	CHM 8k EU + DSL Modem	230 VAC \pm 10%	3 m
8349.21-010	CHM 8k EU + Battery Backup	230 VAC \pm 10%	10 m
8349.02-010	CHM 8k US Basic	115 VAC \pm 10%	10 m
8349.12-010	CHM 8k US + DSL Modem	115 VAC \pm 10%	10 m
8349.22-010	CHM 8k US + Battery Backup	115 VAC \pm 10%	10 m

Table 1 Equipment versions.

Composition of order numbers: 8349.xx-yyy

- 8349 = CHM 8k basic unit (instrument, documentation, transport box)
 xx = Special interface, other features (modem, battery backup, etc.)
 xx = Country code (EU or US)
 yyy = Cable length (003 = 3m; 010 = 10 m; 050 = 50m)

3.2 Technical data

Measurement parameters	
Measuring range	0 m ... 10 km (0 ... 32808 ft)
Cloud detection range	5 m ... 8 km (16 ... 26246 ft)
Resolution (measured)	5 m
NetCDF data resolution (*)	5 m – 30 m in 5 m steps (can be set by the user) 15 m (default setting)
NetCDF high resolution data	5 m (defined for limited HR vector of data)
Logging time and reporting cycle (*)	2 s to 600 s (programmable) Default value: 15 s
Measurement objects	Aerosols, clouds (droplets, ice crystals)
Measured / set parameters	Backscatter raw data Cloud heights up to 9 layers including penetration depth, max. detectable range (MXD), vertical visibility (VOR), Sky Condition Index (SCI), cloud cover (TCC, BCC), ...
Measuring principle	Lidar (optical, time of flight)
Optical parameters	
Light source	Laser diode
Wavelength	905 nm
Pulse energy	2 μ J max. (1.6 μ J typical)
Pulse repetition rate	8 kHz
Filter bandwidth	25 nm
Field-of-view receiver (FOV)	1.1 mrad
Extended NOHD	400 m (for 50 mm aperture)

Data interfaces	
Standard interfaces	RS485 half-duplex (ASCII); LAN (http, (S-)FTP, NetTools)
Optional interfaces	DSL, RS485 full-duplex (4 wire)
Electrical parameters	
Power supply	230 VAC $\pm 10\%$ or 115 VAC $\pm 10\%$
Line frequency	50 Hz, 60 Hz
Power consumption (total)	Max 450 VA with activated case heater (default); Max 300 VA without activated case heater
Power consumption heater	LOM heater: 250 W @115 / 230 VAC Case heater: 150 W @115/ 230 VAC
UPS functionality (optional)	Integrated battery and charger, battery support for measuring electronics and communication
Equipment safety	
General safety	IEC 61010-1:2010 + A1
Laser Protection Class	1M according to IEC 60825-1:2014; complies with 21 CFR 1040.10
Electrical Safety	IEC 61010-1 (TUEV Rheinland certified) UL 61010-1 (TUEV SUEDE certified) AS 61010.1 (Australia and New Zealand) CAN/CSA-C22.2 No. 61010-1 (TUEV SUEDE certified)
Protection housing	IEC/ EN 60529: IP 66; IEC/EN 61010-1: IK06 (1 Joule) UL/CSA 50/50e: Typ 4X (tests ongoing)
Protection electrical safety	Protection class I (protective earth required)
Overvoltage Category	II
Pollution degree in IP66 housing	2
EMC	EN 61326-1: - Immunity class industry - Radiation class residential areas FCC: 47 CFR Part 15, Class B
Conformity	CE, (UL/ CSA housing tests ongoing)
Operating conditions	
Ambient temperature range	-40 °C to +60 °C (in operation, valid for all options) -40 °C to +60 °C (storage incl. UPS option) -40 °C to +85 °C (storage, w/o UPS option)
Relative humidity	0% – 100%
Wind	60 m/s
Maximum operating altitude	5000 m standard units 2000 m with DSL as well with UPS option
Dimensions	
Enclosure dimensions (footprint x height)	W x H x L = 0.5 m x 0.5 m x 1.55 m
Packaging dimensions	W x H x L = 0.75 m x 0.86 m x 1.80 m
Weight	
Weight	70 kg (complete system)
	9.5 kg (measuring unit – heaviest replacement part)

Installation requirements	
Suitable low-voltage distribution systems	TN-S system: grounded mains, grounded CHM 8k enclosure, neutral and protective conductor fed separately and connected separately in device TN-C-S system: grounded enclosure CHM8k, neutral and protective conductor combined in one conductor outside of the device, but fed separately and connected separately in the device.
Connection type	Fixed connection, grounding by means of ground connection clamp (see Figure 12)
Resources to be provided by the operator	
Lightning protection	- Internal lightning protection is provided - External lightning protection must be provided
Grounding	Grounding system according to DIN V VDE 0185-3
Requirements for installation	- Isolation device for disconnection from low-voltage network in close proximity to the CHM 8k - Easily accessible - Marked as belonging to the CHM 8k - Pre-fuse only needed for 230 VAC variant: 10 A gG time-lag

Table 2 Technical data.

(*) the combination of high temporal and range resolution over the full range is limited due to file size and processing time. Any combination of > 70MB daily NetCDF file sizes is not supported by Lufft.
Example (standard operation mode): 15 m range resolution over 10 km range with 15 s time resolution results in 17 MB daily NetCDF file sizes.

4 Technical Description

The CHM 8k ceilometer is mainly used to measure cloud bases, cloud penetration depths, cloud cover statistics, the vertical visibility and the aerosol layer. The calculated data are transferred by remote transmission via standard digital interfaces.

The CHM 8k uses the lidar method as a measuring principle (Lidar: light detection and ranging): short light pulses are emitted into the atmosphere where they are scattered by aerosols, droplets and air molecules. The portion of the light that is scattered back to the ceilometer is further analyzed. The propagation time of the laser pulses is measured and used to calculate the distance of the scattering event.

The height profile of the backscattered signal is analyzed to calculate the attenuated backscatter coefficient as the first output parameter from the instrument. The different target parameters like the cloud base layers and the aerosol layer height are calculated from these data.

The CHM 8k detection system is based on an analog detection method with a 25 nm bandwidth optical filter in front of the detector. It is designed to suppress background light effectively, while being compatible with the broader emission spectrum of InGaAs laser diodes. The analog detection system offers high dynamical range without saturation of the detector.

The CHM 8k ceilometer is:

- A compact device including heater and window blower.
- Capable of operating under the ambient conditions specified in the technical data (see 3)
- Based on modules, e.g. the laser optical unit (LOM) inside the device can be replaced (refreshed) at the end of the laser diode lifetime
- A device designed for 24/7 continuous operation

4.1 Construction of the CHM 8k

The housing of the CHM 8k is made of corrosion-resistant aluminum in double-shell construction. The function of the outer shell is to dampen the external influences of:

- Solar radiation
- Wind
- Precipitation
- Mechanical shock

on the inner shell, which carries the measuring unit. The chimney effect between the outer shell and the inner housing supports this process and avoids high temperature in the inner housing.

The housing cover protects the inner housing against dust and precipitation and mechanical damage on the windows. The housing cover contains the opening for laser exit and laser entry. The partition in the cover decouples the transmission area from the sensitive receiving area. An air baffle inside the cover directs the airflow from both fans directly onto the glass windows of the inner housing.

The inner housing incorporates all the equipment needed to operate the CHM 8k. The cable feed-throughs for data line, power supply and connection of the external fans are realized via cable glands. For pressure equalization, 3 pressure balancing elements (Goretex®) are integrated in the inner housing.

The upper end of the inner housing forms a two-part viewing window made of coated float glass. The windows are inclined at the Brewster angle. This ensures low-loss laser light transmission and optimal self-cleaning of the windows. The fan located at the rear of the device supports the cleaning of the windows: the fans are switched on an hourly interval and in rain / snow. The fans are also used to remove heat from the inner housing. The fans are serviced by a service technician via the removable rear panel of the CHM 8k.

The outer door allows access to the inner housing and the glass windows, e.g. for cleaning purposes. Access to the interior of the inner housing is possible via the inner door. The outer and inner doors are secured with different locking mechanisms. In this way, access to the interior of the inner housing by cleaning personnel who have not been instructed in safety-related matters is excluded. The inner door may only be opened by the service staff of OTT HydroMet Fellbach GmbH or by the customer's authorized and trained personnel.

4.2 Functional units of the inner housing

The functional units of the device are:

- Transmitting and receiving unit (measuring unit - LOM)
- Control board and related components
- Power supply 12 - 15 VDC for the electronics
- Transformer based DC power supply with 48 VDC output for fans
- Housing fan and temperature sensors
- Lightning and overvoltage protection devices for power cable, LAN, RS485

The functional units are of modular design, fastened separately to the inner housing and can be removed and replaced individually for servicing purposes.

4.2.1 Functional diagram

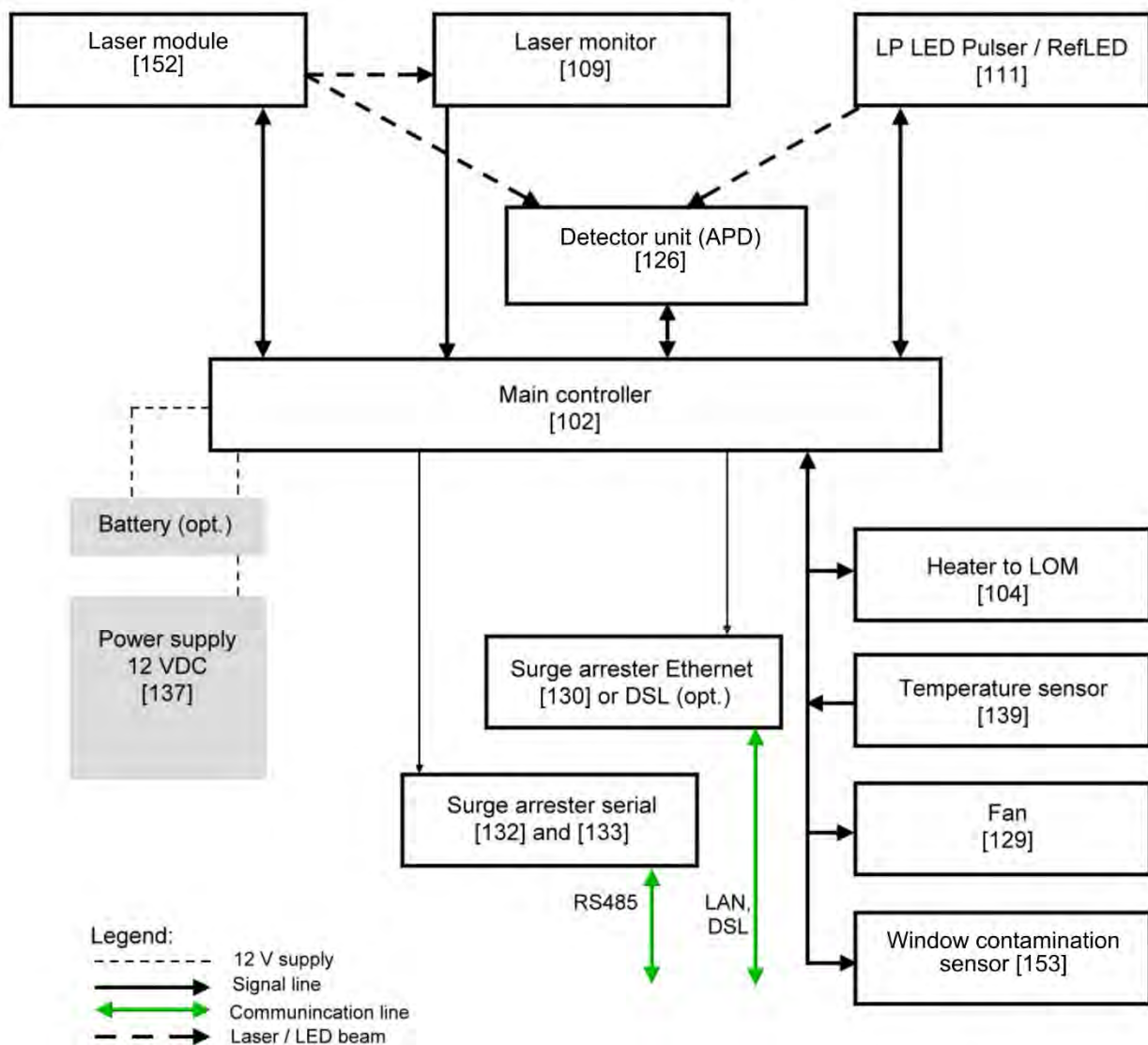

Figure 2 Functional chart, the numbers in brackets corresponds to the numbering in the spare parts list (provided in the service manual or as an extra list).

Figure 2 clearly shows that the main controller is the central unit. The main controller controls and monitors all device functions shown here and provides corresponding status values.

4.2.2 Function control and device status

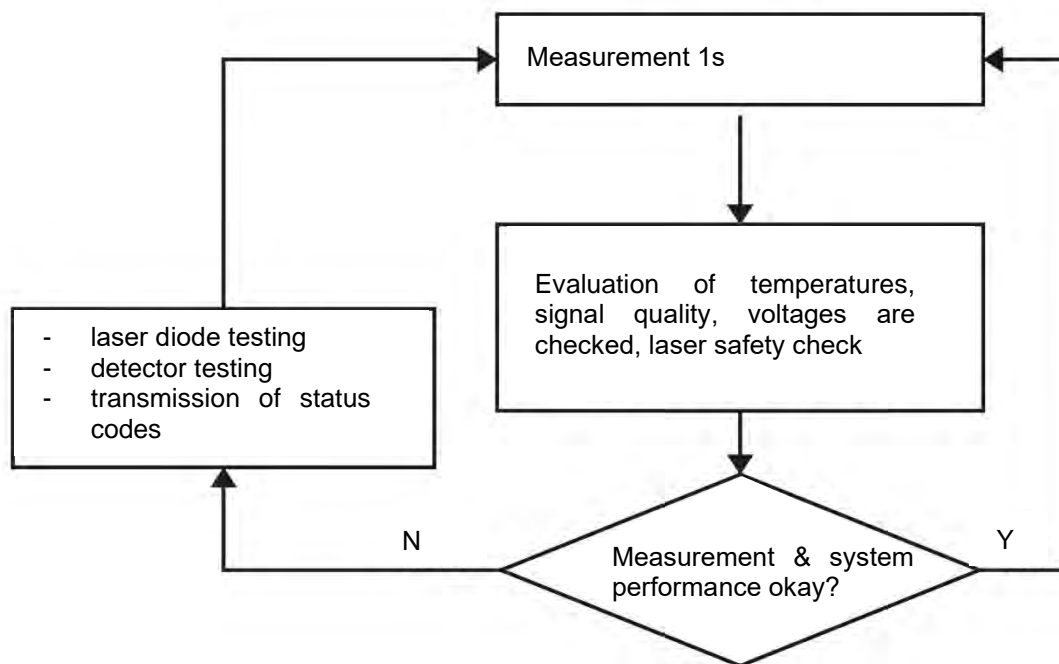

Figure 3 Flow chart - standard measuring cycle.

The functional control of the CHM 8k (measurement and evaluation) is performed by an FPGA and an OMAP processor. The logging interval (not shown here) consist of multiple measuring cycles calculated in the OMAP processor, while processes with higher time resolution of up to 1s time intervals are processed in the FPGA.

Figure 3 shows the internal measurement cycle that takes place every second. The measured data and the evaluation of the status parameters are checked after each measurement cycle. If the values are outside the tolerances or there is a hardware error, the standard measurement cycle is reinitialized, and an error message is generated and output.

However, there are parts that are controlled internally with higher time resolution, such as the temperature control of the laser and processes that run in the logging interval, such as the evaluation of the window contamination sensor [153] and the fan controller in case of precipitation. Laser safety is also monitored by the FPGA and the firmware, independently of the above measurement cycle. In addition, there is a watchdog circuit that monitors the operating system and relevant voltages, and a software watchdog to control the firmware processes. Determined values and status values are output in the extended data telegram and the NetCDF files. The standard message contains rough information about the status code (see 8.5 Status code).

5 Transport / Scope of Delivery

NOTICE

The device may be damaged if handled inappropriately.

- ⇒ The CHM 8k may only be transported and moved using suitable transport equipment and lifting gear.
- ⇒ The CHM 8k may only be loaded and transported in the packed condition and in the transport position (see Figure 5).
- ⇒ Inside the shipping container/ truck, the CHM 8k must be adequately protected against slipping, shock, or other mechanical impacts.

The scope of delivery includes:

- CHM 8k ceilometer
- Grounding cable 2.6 m
- Ring binder with documents
 - Drilling template
 - Mechanical setup instruction
 - Electrical setup instruction
 - Test protocol
 - List of serial numbers of build in components
 - User manual
 - In the EU: Declaration of conformity
- Fastening components:
 - 4 dowels S12 (Fischer Co.)
 - 4 screws M10 x 140-ZN (DIN 571)
 - 4 washers ISO 7093-10.5-KST/PA
 - 4 washers ISO 7093-10.5-A2

On customer's request:

- An adapter frame can be supplied, which allows the CHM 8k to be screwed to existing fastening bolts.
- An angle adapter frame can be supplied, e.g. for 15° to tilt ceilometer away from direct sunlight.



Information about required tools

Spanner / wrench for 4x M10 screws: 17 mm or 3/8 Whitworth. A 3/8-inch screw with appropriate anchors can be used instead of the M10 screw. The leveling screws require a 22 mm spanner or 1/2 Whitworth.

For further technical details, please contact OTT HydroMet Fellbach GmbH.

Operating status of the CHM 8k on delivery

Transfer mode	1, automatic output of the standard data telegram
RS485 device number	16
Baud rate	9600
Measuring period	15 seconds

For detailed information on the operating statuses, see chapter 8 Communication via RS485 & Ethernet.

6 Installation

NOTICE

- ⇒ The operator of the CHM 8k is responsible for creating and dimensioning the foundation. The foundation must be dimensioned so that it can cope with the permanent stress caused by the weight of the equipment and external influences.
- ⇒ To prevent the ingress of dirt or moisture, the device must not be opened during installation and commissioning.

The CHM 8k ceilometer is installed on and fixed to a suitable concrete foundation. Integrated leveling screws on the underside of the foot allow the device to be vertically aligned and thus facilitate the vertical orientation of the measuring unit.

Install the CHM 8k in a protected outside area. Avoid radiation from strong light sources. The sun radiation angle must be $\geq 15^\circ$ to the vertical. Please request a suitable angle adapter. The distance to trees and shrubs must be selected such that leaves, and needles do not reach the light emission apertures of the device. When installing the CHM 8k, the following minimum distances must be observed:

- to radio devices 2.5 m
- to stationary transmitters / base stations (≥ 100 W transmission power) 25 m
- between two ceilometers (optical interference possible) 10 m

6.1 Installing the CHM 8k

6.1.1 Preparatory work

The CHM 8k requires an installation area of 50 x 50 cm. It must be stable, firmly installed and mounted on an adequately sized concrete foundation. The inclination of the installation surface must not exceed 5 mm/m. Before installing the CHM 8k, holes must be drilled and dowels inserted in the concrete foundation (\varnothing 12 mm, 4 dowels are included in the delivery), in accordance with the drilling template (see Figure 4). It is important to pay attention to the opening direction of the exterior door to the operator's connection box.

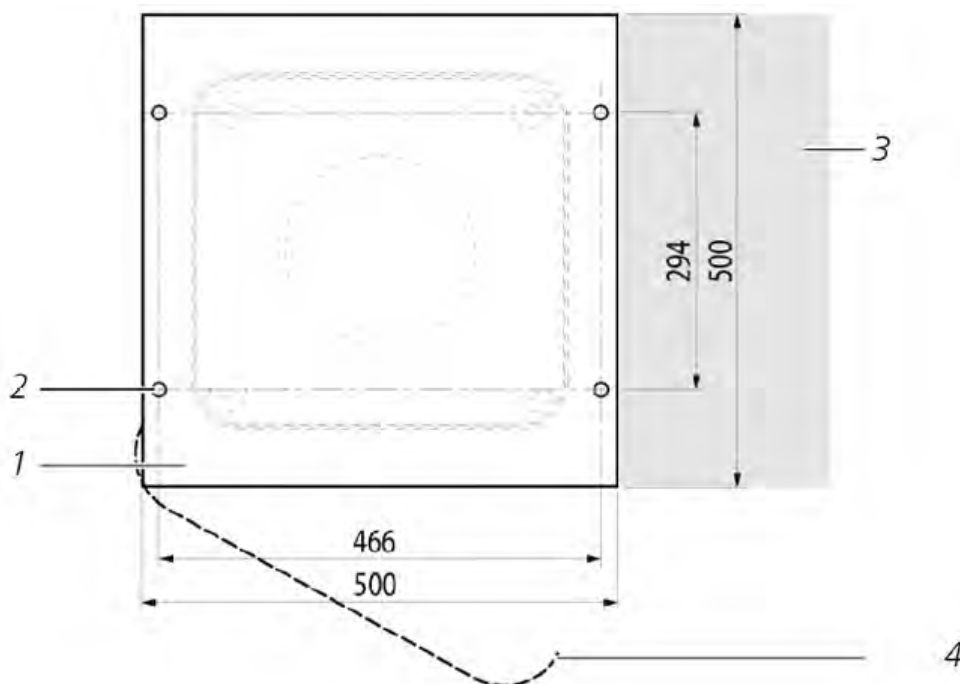



Figure 4 Drilling template.

- 1 Drilling template
- 2 Drill holes (\varnothing 12 mm) for fixing
- 3 Possibility of electrical connection (connection box)
- 4 Opening direction of the exterior door

6.1.2 Installing on the foundation

⚠ CAUTION	
	<p>The CHM 8k weighs 70 kg, heavy equipment may cause serious injury.</p> <ul style="list-style-type: none"> ⇒ Do not attempt to move the CHM 8k without adequate help ⇒ At least two people are required to install the ceilometer

Install the CHM 8k ceilometer as follows:

- ⇒ Unload the CHM 8k from the transport equipment and set it down as close as possible to the place of installation. The position of the base of the instrument inside the transport crate is marked with “Boden / Base” on the crate.



Figure 5 CHM 8k packed and in transport position (1: wooden crate, 2: pallet).

- ⇒ Loosen the clamps on the cover plate (use a flathead screwdriver of suitable width).
- ⇒ Lift the cover plate upwards and set aside.
- ⇒ Remove the clamps of the side walls and put panels aside.

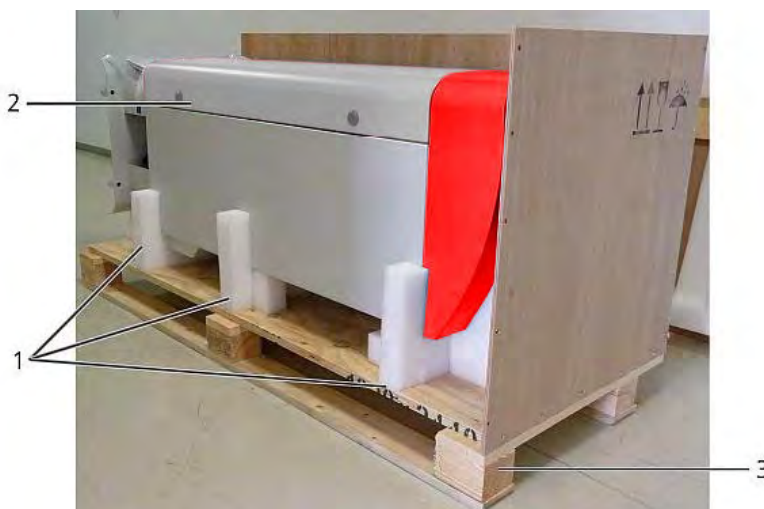

Figure 6 The CHM 8k with Styrofoam or paper honeycomb packing pads.

- 1 Here: Polystyrene packaging
- 2 CHM 8k
- 3 Pallet

- ⇒ Carefully lift the CHM 8k out of the polystyrene packaging or paper honeycomb packaging by hand, observing all safety regulations. (Lifting positions: Figure 7).

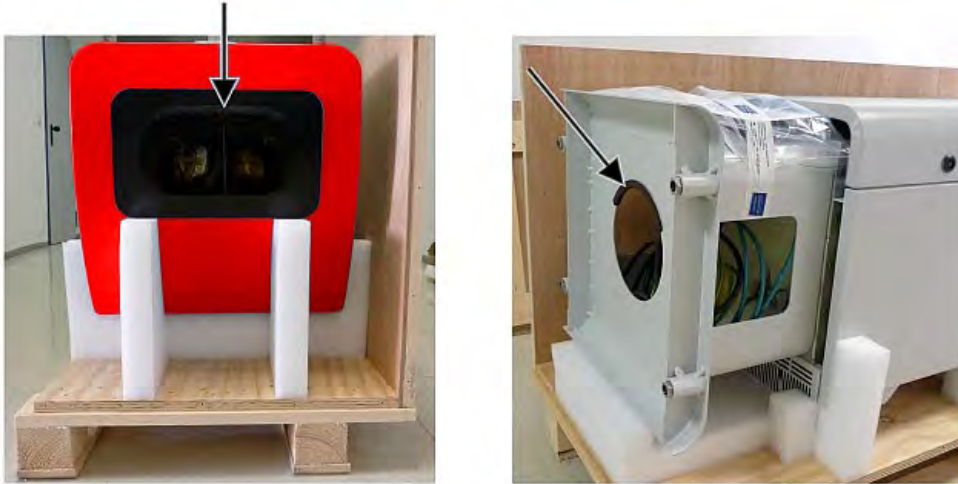

Figure 7 Lifting positions and handle protection (edge protection profile).

Onward transport options:

- ⇒ To carry: Grasp the equipment in the openings marked with arrows (Figure 7).
- ⇒ Hand truck: For greater distances to the concrete foundation (Figure 8).

NOTICE	
<ul style="list-style-type: none"> ⇒ When transporting with a hand truck, make sure that the CHM 8k is placed on the hand truck with the exterior door facing downwards (see Figure 8). ⇒ A cushion (e.g. bubble wrap) should be placed between the CHM and the hand truck. 	



Figure 8 Transport with hand truck.

- ⇒ Position the CHM 8k in the installation position (vertical) on the concrete foundation. It is important to pay attention to the position of the exterior door in relation to the operator's connection box (see Figure 4).
- ⇒ Loosely pre-assemble the CHM 8k on the concrete foundation with the supplied washers and fixing screws (see Figure 9).

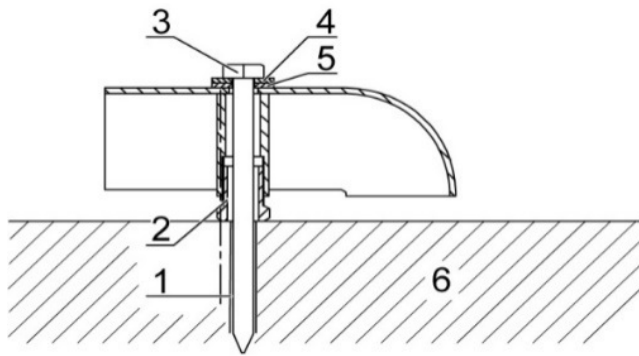

Figure 9 Fixing elements.

- 1 Dowel S12
- 2 Leveling screw 5 mm (integrated into the base of the device)
- 3 Screw DIN 571-10 x 140-ZN
- 4 Washer ISO 7093-10.5-A2
- 5 Washer ISO 7093-10.5-KST/PA
- 6 Concrete foundation

- ⇒ Vertically align the CHM 8k using the levelling screws integrated into the base of the device (with a spirit level: place on one side wall and on the front). Tools required: 22 mm spanner / wrench.
- ⇒ Tighten the fixing screws. Tools required: 17 mm spanner / wrench.
- ⇒ Remove the handle protection (edge protection profile) from above and secure in the base for the next transport.

6.2 Electrical installation

NOTICE

Incorrect installation may result in damage to the equipment.

- ⇒ The electrical connection of the CHM 8k may only be carried out by a qualified electrician of OTT HydroMet Fellbach GmbH or another qualified electrician. Failure to comply will result in the loss of warranty and warranty claims.
- ⇒ The operator must meet all the requirements for connecting the CHM 8k ceilometer in accordance with EN 61010-1, e.g., installation of a connection box.
- ⇒ An overvoltage and lightning protection system is installed within the Ceilometer. If the customer needs to measure the isolation resistance, then it is allowed and needed to use 250V DC. The value of the isolation resistance must be above 1 MΩ.

Figure 10 shows a schematic sketch of the electrical installation of the CHM 8k. The power supply (1) to the device must be connected via an external mains switch (2) which needs to be easily accessible to cut the power to the device when required. It must be marked as belonging to the CHM 8k and a pre-fuse 10A gG time-lag must be used only for 230VAC-devices. The connection box should be installed at a distance of < 3 m. An external lightning conductor (7) must be installed to protect the device from direct lightning strikes. All connections to the device must be made according to the respective country-specific regulations.

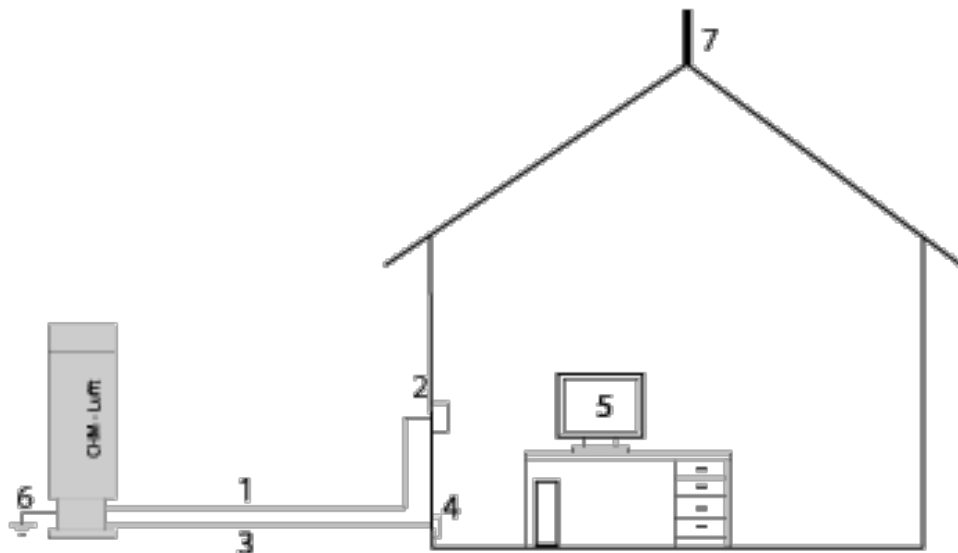



Figure 10 Schematic sketch of the electrical installation.

- 1 Power supply (3-pole)
- 2 Mains switch and electric junction box
- 3 Data transfer cables: RS485 or LAN,
- 4 Data cable connection: RS485 or LAN
- 5 PC for remote access (via LAN/DSL; PC must not be local)
- 6 Ground connection ceilometer
- 7 Lightning conductor

⚠ WARNING	
	<p>Touching live parts may result in electric shock, which will cause serious or fatal injury.</p> <p>⇒ Switch off the external circuit breaker before starting the installation and secure against reconnection.</p>

The electrical connections to the CHM 8k are specified in more detail in Figure 11. Connect the mains and data cables as shown in this figure. It is recommended to include external overvoltage protection in all connections to the device to prevent damage to the connection box. Internal lightning protection is provided in the device.

The CHM 8k is connected via the following supplied cables:

1. 230 VAC supply cable (mains cable): color code: neutral conductor: blue, conductor: brown, protective conductor: green-yellow); standard length 10 m.
OR
115 VAC supply cable (mains cable): color code: conductor black, neutral: white, protective conductor: green / green-yellow

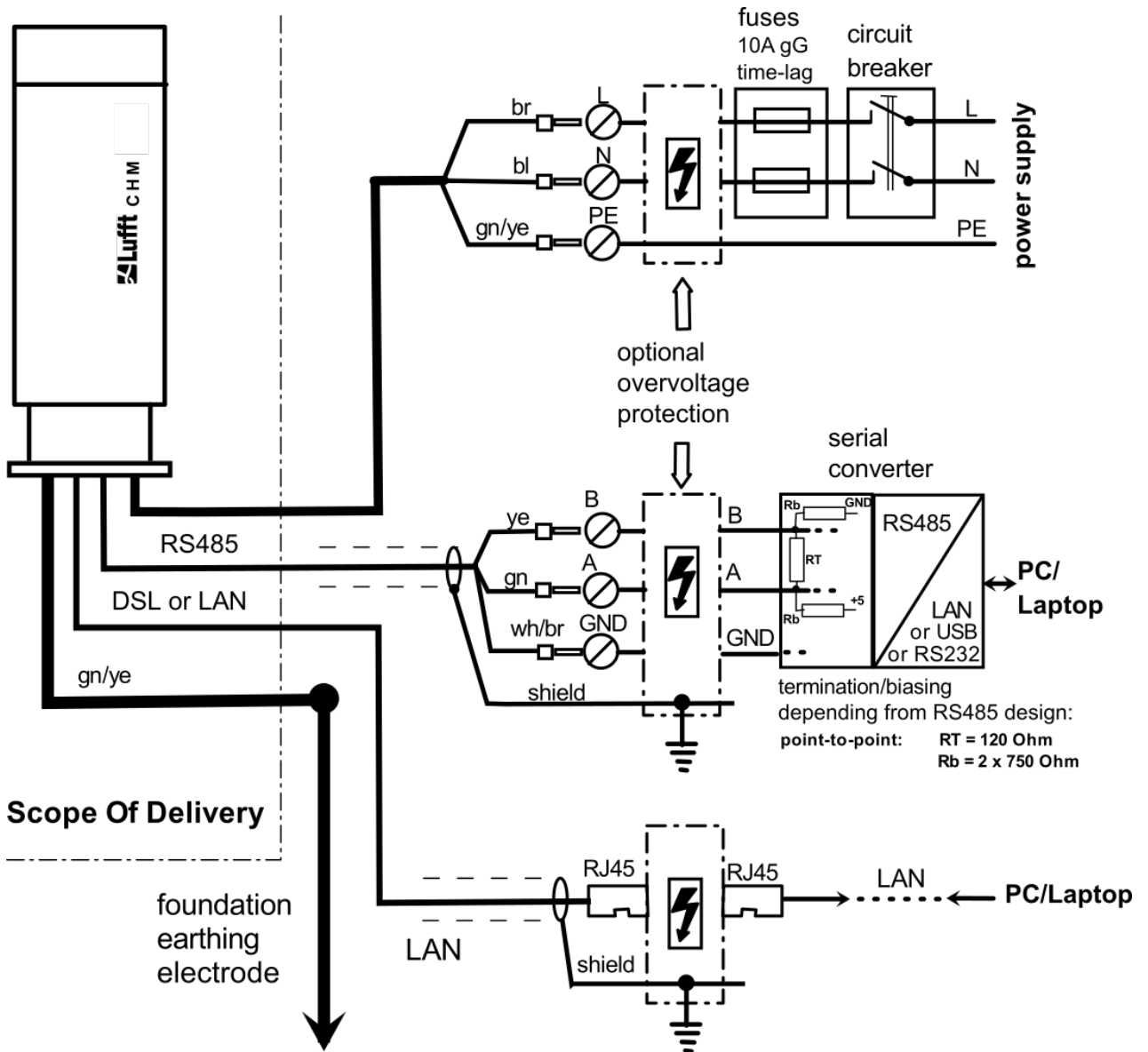

Figure 11 Electrical installation CHM 8k

2. Grounding cable 10 mm² (1-pin, green-yellow), standard length 2.6 m, for the grounding connection (see Figure 12). The grounding cable must be kept as short as possible.



Figure 12 Grounding connection at pedestal of device.

3. Data cable (RS 485, 3 wire): A (-) conductor: yellow; B (+) conductor: green; RS485 - GND: white & brown; shielding as required: (see Figure 13); standard length 10 m.

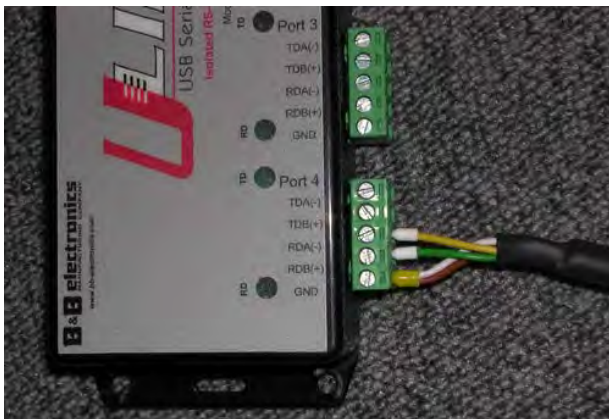

Figure 13 RS485 connection to transducer.

4. Data cable (LAN): equipped with a standard RJ45 plug, for connection to a remote computer, hub or switch, standard lengths 5 or 10 m.

7 Commissioning and Decommissioning

7.1 Starting up with the RS485 connection

Requirements:

- The CHM 8k ceilometer must be installed correctly
- Control cable (RS485), grounding cable and mains cable (115 VAC or 230 VAC) must be connected
- A terminal program, e.g., HyperTerminal or Bray's terminal, can be used under Windows for monitoring communication. It has to be configured for communication as follows:
 - Baud rate: 9,600
 - Data bits: 8
 - Parity: none
 - Stop bits: 1
 - Flow control: none

⚠ CAUTION	
	<p>After switching on the power supply, the CHM 8k emits Class 1M invisible laser radiation through the opening at the top of the sensor. When viewed with optical instruments, Class 1M radiation can lead to serious eye injuries.</p> <ul style="list-style-type: none"> ⇒ Never view the laser beam with optical instruments, especially binoculars ⇒ Avoid looking directly into the laser beam

After connecting the supply voltage, the CHM 8k will start up by itself. During the start-up process an internal self-check is done, e.g. the fans start for a few seconds. Communication with the device is possible within 1 minute. The CHM 8k will be fully operational after a temperature adjustment phase of varying length depending on outdoor temperature conditions. The time until measurement data are available in high quality, can be between 2 minutes (warm start) and one hour (cold start at -40 °C).

The CHM 8k automatically sends out standard data telegrams when the start-up procedure has been completed. It is part of the default setup and might differ for user specific CHM 8k start settings. The automatic output every 15 s is helpful to check if the communication works correctly without entering any command.

To change the start-up behavior like polling vs automode or the telegram that should be used at start see chapter 8 Communication via RS485 & Ethernet.

Test commands for RS485 communication

To test the communication, use the command (RS485Number = 16 (default value)):

set<SPACE><RS485Number>:Transfermode=0<CR><LF>

This command changes the settings from auto to polling mode. Testing in polling mode is helpful to avoid interruptions by automatically sent telegrams while typing. 9 telegram types are available:

- Standard data telegram (short name: 1 or s)
- Extended data telegram (short name: 2 or l)
- Raw data telegram (short name: 3 or a)
- User telegrams (short name: 4, 5, ..., 9)

Section 8 describes the possible commands and their effects in detail. Some commands for functional testing required in routine operation or to setup the system in the beginning are listed in Table 3.

Command	Description	Response (shortened)
get<SPACE>16:L<CR><LF>	Output of extended data telegram	see 8.3.4
set<SPACE>16:RNO=14<CR><LF>	Sets the RS485Number from 16 to 14	set 16:RNO=14
set<SPACE>16:Baud=4<CR><LF>	Sets baud rate to 19,200	set 16:Baud=4
set<SPACE>16:dt(s)=15<CR><LF>	Sets logging time interval to 15 s	set 16:dt(s)=15
get<SPACE>16:Lifetime(h)<CR><LF>	Readout of the laser operating hour counter	get 16:Lifetime(h)

Table 3 Commands for functional testing (examples).

After completing the simple functional test on the CHM 8k:

- Continue to operate in polling mode, or
- Reset to automatic transmission mode

set<SPACE><RS485Number>:Transfermode=1<CR><LF>

Comment: This command leads back to the automatic transmission mode of the standard telegram 1.



Baud rate with raw data transmission

The baud rate settings must be observed, especially in RS485 bus mode. If raw data transmission is required, each telegram can be 12 kB in size. To reduce the transmission time between two 15 s telegrams the baud rate must be set to at least 19,200 baud.

7.2 Starting up with the LAN connection

In addition, or as an alternative to the RS485 connection, a LAN connection (Ethernet) can also be used.

Requirement: A connected LAN cable (see 6.2 Electrical installation) or LAN over DSL connection with a DSL transmitter and receiver modem in between.

Configuration: 3 separate IP addresses are available for simultaneous communication:

1. A preconfigured fixed service address to the device
→ **192.168.100.101, subnet 255.255.255.0**
2. DHCP server assignment (requires a DHCP server)
3. User address + subnet + gateway,
see section 8.7 Communication via Ethernet web interface for the configuration with a LAN / WAN connection to the device and 8.2, if these values are configured with the RS485 interface.

The service address (1) cannot be changed by the user. It is always available and can be used as a direct connection between a laptop and the CHM 8k.

One of the 3 IP addresses can be entered into a web browser (see Figure 14) for communication with the device. Figure 18 shows the "Config Network" tab in the Internet browser Firefox. Changing the user IP address (3) requires superuser authorization in the device tab.

The superuser password is: 8k-MHC

The superuser password can be changed if necessary, see Figure 21.

The web interface was tested with the following web browsers:

- Internet Explorer 8 or later
- Firefox 3.6 or later
- Google Chrome
- Apple Safari

In the DHCP network environment (2), the CHM 8k is configured automatically. The DHCP mode can be switched off.

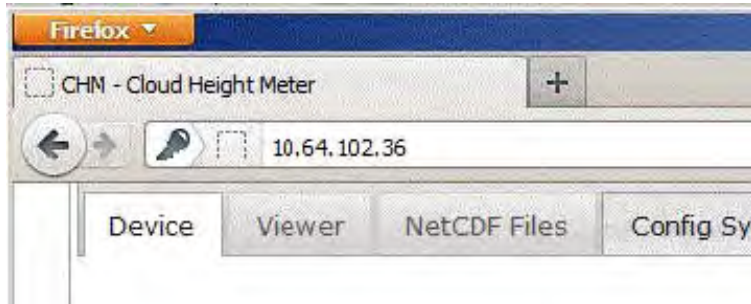

Figure 14 Firefox browser for a connection with the CHM 8k (shown here with fixed IP address).

It is possible to use the RS485 connection and query the DHCP IP address by entering:

get<SPACE><RS485Number>:IPD<CR><LF>

If available, the device transmits the DHCP address that can be used in a second step in a web browser to connect to the system via a LAN connection.

The user IP address can be set or queried by the user via RS485, too, using the parameter IPS instead of IPD, e.g.:

get<SPACE><RS485Number>:IPS<CR><LF>

set<SPACE><RS485Number>:IPS=xxx.xxx.xxx.xxx<CR><LF>

For further support regarding communication please contact OTT HydroMet Fellbach GmbH.

7.3 Shutdown

Advanced users should carefully disconnect the device from the power supply with these steps:

- ⇒ Users with superuser authorization should use the web interface: Log in as a superuser and press "SHUTDOWN SYSTEM" on the device tab
- ⇒ RS485 users can enter the following command:

set<SPACE><RS485Number>:SHT<CR><LF>

- ⇒ In both cases the Linux-based system is turned off and measurement data are stored on the local SD card.

After the soft shut down the main power can be disconnected without the risk of data loss.

- ⇒ To uninstall the CHM 8k and reinstall it at a different location, carry out the steps described in sections 6.1.2 Installing on the foundation and 6.2 Electrical installation in reverse order.

7.4 Disposal



Disposal Notice

Disposal of the CHM 8k Cloud Height Meter must be in accordance with national regulations. Electrical equipment marked with this symbol may not be disposed of in European domestic or public disposal systems. Return old or end-of-life equipment to the manufacturer for disposal at no charge to the user.

8 Communication via RS485 & Ethernet

The CHM 8k supports the interfaces RS485 (see section 8.2) and Ethernet (see section 8.7) for communication with the device. Both offer the possibility of data transfer of the measured values and the configuration of the device and can be used at the same time.

A web interface is part of the device for the communication via the Ethernet interface. Regardless of the operating system, the ceilometer can be accessed through various web browsers.

The web interface can also be used to manually download the measured data stored in NetCDF daily files on a built-in SD card (see section 8.4). Also implemented on the system is an AFD (ftp) service (see section 8.8) which, for example, allows data in the form of 5-minute blocks of NetCDF files to be transferred to an external FTP server.

RS485 communication requires a terminal program.



Transmit and receive with RS485

The RS485 interface does not allow simultaneous send and receive operation (half duplex mode). Accordingly, the interface is automatically switched internally. Hence, while receiving an automatically transmitted data telegram (see sections 8.3.3 to 8.3.5), it is not possible to send other commands (as described in 8.1). The incoming start and end flags <STX> and <EOT> indicate a current receive transmission.

8.1 List of configurable parameters

Table 4 lists the most important settings. These are explained in the following sections. To prevent unwanted effects on the functioning of the device, some options can only be set in service mode (RS485) or in super user or service user mode (Ethernet), such as the device name. Table 5 shows a list of other parameters (read-only properties). These parameters are stored in part on the EEPROM on the measuring unit and affect data evaluation and the basic system settings. The tables contain the permissible value range and the character length when applicable for each parameter as well as the default value of the device. Text-parameter will be cut to their maximum field length. They also contain an indication when the service mode is required or when the parameter availability is different between RS485 and web-interface.

Parameter	Short cmd <i>RS485 only</i>	Default value	Range / short description / [max. character length]
AfdMode*	AFD	0	0; 1, switch on (s)ftp data transfer
Altitude(m)	ALT	0	0 – 9999, unit is always in meters
ApdControlMode*	ACM	2	0 – 2, APD mode, change only if function is known in detail
Azimuth	AZT	0	0-360 degrees (x 100) ^{Web} (e.g. 12.25 ^{RS485} and 1225 ^{Web})
Baud	BAU	3	2 – 7 (4,800 – 115,200 baud)
BaudAfterError*	BAE	3	2 – 7 (4,800 – 115,200 baud)
BlowerMode	BLM	0	0 – 4
ChmTest*	CHT	0	0; 1
CloudDetectionMode	CDM	3	0 – 3, switch between variants of algorithm (Bit 0 = HLC, Bit 1 = BLC)
Comment	COM		Comment; also stored in the NetCDF file [31]
Comment 1 ^{RS485}	CM1		Additional comment field [31]
Comment 2 ^{RS485}	CM2		Additional comment field [31]

Parameter	Short cmd <i>RS485 only</i>	Default value	Range / short description / [max. character length]
Comment 3 ^{RS485}	CM3		Additional comment field [31]
Comment 4 ^{RS485}	CM4		Additional comment field [31]
Comment 5 ^{RS485}	CM5		Additional comment field [31]
Comment 6 ^{RS485}	CM6		Additional comment field [31]
Comment 7 ^{RS485}	CM7		Additional comment field [31]
DateTime			UTC Time in the format DD.MM.YYYY;hh:mm:ss ^{RS485} and MMDDhhmmYYYY ^{Web} (see Figure 21)
DeviceName*	DVN	CHMyxxxx	Serial number of the device [31]
DeviceType*	DVT	0	Switch NetCDF format
DHCPMode	DHM	1	0;1 switch DHCP mode on / off
DNSServer	DNS		Set / queries IP address of name server [63]
dt(s) ^{RS485} LoggingTime ^{Web}	DTS	15	Logging and reporting time: 2 – 600 s
Gateway	GAT	0.0.0.0	Set / request the static gateway address {15}
HardwareVersion*	HWV		Device-dependent, see Table 25
HttpPort	HPT	80	Specifies http port to access the web interface of the ceilometer
IgnoreChars*	ICH	06	8-bit ASCII codes [31]
Institution	INS	NN	Institution (text field) [63]
IPAddress	IPS	0.0.0.0	Set / query the static IP address [15]
LanPort	LPT	11000	Port for telegram transmission via Ethernet
LanTelegramNumber	LTN	2	Telegram format for Ethernet transmission (1 – 9), see section 8.3
LanTransferMode	LTM	1	Communication mode for telegram transmission via Ethernet (0 = polling; 1 = automatic sending)
LaserMode*	LSM	1	Switch laser on / off
LaserFrequencyMode*	LFM*	0	0 – 13, set the laser repetition rate
Latitude	LAT	0	-90 to +90 degrees (x 10 ⁶) ^{Web} (e.g. 52.430210 ^{RS485} and 52430210 ^{Web}) „+“ is degrees North
Layer	NOL	3	1 – 9, number of cloud layers
Location	LOC	NN	Alphanumeric string (max. 31 characters, \ / : * ? " < > _ # % not allowed)

Parameter	Short cmd <i>RS485 only</i>	Default value	Range / short description / [max. character length]
Longitude	LON	0	-180 to +180 degrees (x 10 ⁶) ^{Web} (e.g. 13.524735 ^{RS485} and 13524735 ^{Web}) „+“ is degrees East
MaxCrosstalkChars*	MCC	5	0 – 1024
NetcdfMode	NCM	1	Cannot be changed for the CHM8k
NetMask	NMA	0.0.0.0	Set / query the static Netmask address [15]
NtpMode	NTM	1	0; 1 switch ntpd on / off
NtpServer	NTS	0.0.0.0	Set / query NTP time server address [15]
PeltierMode*	PTM	1	0; 1
RangeEnd	RAE	10000	Last range value in a NetCDF file
RangeHRDim	RHD	32	Number of data points in the high-resolution data vector
RangeResolution	RAR	3	Number of 5 m range intervals averaged for the NetCDF data vector
RangeStart	RAS	5	First range value in a NetCDF file
Reset	RST	0	0; 1 restart of the CHM (see 8.2.4)
ResetPassword*	RSP	0	0; 1; reset the super user password
ResetSettings	RSG	0	0; 1 reset to the factory settings, (see 8.2.4); In web interface: “set to factory setting”
RestartNetwork	RSN	0	0; 1 writes the new settings in the configuration file and restarts the network
RS485Number	RNO	16	0 – 99 (used with RS485)
ServiceMode ^{RS485}	SMO	0	0; 1 switches to the service mode to change “critical” values
Shutdown	SHT		0; 1 shuts down the CHM system
Standby	STB	0	0; 1 Standby mode with standby telegram to reduce power consumption
SystemStatusMode	SSM	1	0; 1 the escalated status code will be used in the telegram if set to 1
TimeOutRs485(s)*	TOR	30	5 – 3600
TimeZoneOffsetHours	TZH	0	-12 12 hours, e.g. CET is +1, used to control the window ventilation
TransferMode	TMO	1	0 – 9, see section 8.3
TransferModeAfterError*	TME	1	0 – 9

Parameter	Short cmd <i>RS485 only</i>	Default value	Range / short description / [max. character length]
ToggleMainboardFan*	TMF	0	0; 1 0 = auto (depending on temperature) 1 = on for 10 minutes, then "0" again
UAPD*			Device-dependent in mV (e.g. 172000)
Unit(m/ft)	UNT	m or 0	m; ft ^{RS485} bzw. 0, 1 ^{Web}
UseAltitude	UAL	0	0; 1
WIGOSStationID	WSI		Set / query the WIGOS station identifier [31]
WMOStationCode	WSC		Set / query the WMO station code
Zenith	ZET	0	0 - 90 degrees (x 100) ^{Web} (e.g. 10.25 ^{RS485} and 1025 ^{Web}) 0° is vertical

Table 4 List of configurable parameters,

* can be set in service mode,

^{Web} format for web interface, or only in web interface available

^{RS485} format for RS458, or only for RS485 available

Parameter	Short cmd ^{RS485}	Default value	Description
APDBreakdown	UBR		Device-dependent (e.g. 172000 mV)
ApdTempGradient	TCO		Device-dependent (e.g. 1090 mV/K)
IPDhcp	IPD		IP address DHCP
LifeTime(h)	LIT		Number of hours that the laser is in operation
Parameters ^{RS485}			Lists all parameters that are available in the RS485 mode
SerLOM	LOM	TUByyxxxx	Serial number laser optical module (LOM) [15]
SystemLifeTime(h)	SLT		Operating hours of the CHM system
TBCalibration	TBC		Scaling factor compared to reference
VersionFirmware	VFI		Firmware version (data processing and handling)
VersionFPGA	VFP		Firmware FPGA
VersionLinux	VLI		Operating system version

Table 5 List of read-only parameters, accessible via the RS485 interface;

^{RS485} only for RS485 available

Explanatory notes to Table 4

AFDMode: Switch on / off the extended file distribution system via LAN / WAN / DSL, see <http://www.dwd.de/AFD/> for more information or section 8.8 AFD mode.

Altitude(m): Specification of the height of the location above sea level in meters. In NetCDF files, the parameter CHO (Cloud Base Offset) is used. It logically combines the variables Altitude and UseAltitude.

Azimuth: Specification of the horizontal angle in degrees.

Baud: Change baud rate (see 8.2.3 Changing the baud rate).

BaudAfterError: Default baud rate after communication error (see 8.2.3 Changing the baud rate).

BlowerMode: Used to test the window fans and switch to different operating modes. Mode 2: "rest at night" works only correctly if the parameter TimeZoneOffsetHours is set correctly, too. 0 = hourly check and weather-dependent, 1 = no hourly check from 22:00 to 06:00, 2 = off from 22:00 to 06:00, 3 = always on, 4 = always off.

DataTime: Sets the date and time (see 8.3.6 Additional data telegrams).

dt(s): Logging time interval (in automatic mode identical to the reporting time). A longer time interval leads to time averaging over more laser pulses (shots) and thus to an improved signal / noise ratio. An increase by the factor n leads to an improvement by the factor root n. All raw data in the time interval dt(s) are included in the evaluation. Single data selection does not take place.

DeviceName: Device acronym (CHM) combined with the serial number of the device, e.g. CHM178001.

IgnoreChars: Specific 2-character HEX codes, e.g. "06" corresponds to <ack>, can be added to a list of characters that should not be evaluated by the CHM 8k instrument.

Institution: Institution or company.

Lasermode: Switches the laser on / off, useful option for testing.

LaserFrequencyMode: Changes the laser frequency (LF). The assignment of LaserFrequencyMode to laser repetition rate in Hz is defined as follows:

0 = 8000,0	5 = 7874,0	10 = 7974,5
1 = 7824,7	6 = 7886,4	11 = 7987,2
2 = 7837,0	7 = 7898,9	12 = 8000,0
3 = 7849,3	8 = 7923,9	13 = 8025,7
4 = 7861,6	9 = 7961,8	

Latitude: Latitude of the location, decimal, example Berlin: 52.51833 (corresponds to 52° 31' 6" N).

Layer (Number of Layers): Number of cloud layers displayed in the extended telegram and NetCDF file.

Lifetime(h): Queries the operating hours of the laser (laser lifetime).

Location: Sets / queries the location of the device. The name of the device is limited to a maximum of 31 characters, \ / : * ? " < > | _ # % are not allowed.

Longitude: Longitude of the location, decimal, orientation to east positive, example Berlin: 13.40833 (corresponds to 13° 24' 30" E).

MaxCrossTalkChars: The number of characters the CHM 8k will ignore within the time interval "TimeoutRS485(s)" if not ended with <EOT> (04 HEX), <CR> (0D HEX), <LF> (0A HEX). The parameter is implemented to prevent the ceilometer to fall back in its standard baud rate caused by noise on unstable communication lines.

Parameters: Queries the complete parameter list.

RS485Number: Designates the identification number in a RS485 bus system that is required to select a specific device via a data interface. In addition to the specific address, each CHM device responds to the universal identification number 99.

Standby: Switches off laser, heater and fan.

SystemStatusMode: Defines the status code variant to be used in the data telegrams. 0 = normal, 1 = escalating status codes. See section 8.5 Status code.

TimeOutRS485(s): Sets a time interval for MaxCrossTalkChars and BaudAfterError (default 30 s).

Time Zone offset hours: Must be set to correct the local nighttime, e.g. to switch off the fans at night. The system itself operates in UTC time.

TransferMode: See 8.3.1 Polling mode to 8.3.5 Raw data telegram.

Unit(m/ft): Specifies the target units in meters (m) or feet (ft).

UseAltitude: Inclusion of Altitude(m) in the data output. For example, an entry of 60 m for the altitude increases the transmitted cloud base height by 60 m if UseAltitude is set to 1 (true).

Zenith: Specifies the vertical angle in degrees, the Sky Condition Algorithm (SCA) uses this angle to calculate the actual height of the cloud base.

8.2 Device configuration with RS485

The user can change settings via the RS485 interface:

- for controlling the measuring processes
- for configuring the communication interfaces

8.2.1 Reading out a parameter

A parameter can be queried with the command:

```
get<SPACE><RS485Number>:<ParameterName><CR><LF>
```

If <ParameterName> contains a valid name according to Table 4 or Table 5, the value is delivered via

```
<STX>get<SPACE><Device>:<ParameterName>=<Value>;<ASCIITwo'sComplement><CR>
<LF><EOT>
```

Example with the default RS485Number 16 and the device name CHM198001

The short command

```
get 16: DVN<CR><LF>
```

can be used to query the device name and receive a response, here:

```
<STX>get 16:DeviceName=CHM198001;8E<CR><LF><EOT>
```

Each of the non-printable characters <STX>, <CR>, <LF> and <EOT> stand for one byte with hexadecimal codes 02, 0D, 0A and 04. The characters 3F represents the checksum of the two's complement formed over the whole response line, excluding these two characters (3F) in accordance with the protocol response formats (see sections 8.3.3 to 8.3.5).

8.2.2 Setting a parameter

A configuration parameter is changed via the command

```
set<SPACE><RS485Number>:<ParameterName>=<Value><CR><LF>
```

A successful change is confirmed with

```
<STX>set<SPACE><RS485Number>:<ParameterName>=<Value*>;<ASCIITwo'sComplement>
<CR><LF><EOT>
```

If <value> in the query command is within the limits of the permissible value range, the newly set value <value*> also corresponds to this parameter. If the values are too small (too large), the minimum

(maximum) of the permissible range is used. Alphanumeric values <value> that exceed the maximum length of the parameter are truncated.

Example with RS485Number = 16:

With the command

set 16:Unit(m/ft)=ft<CR><LF>

or in the short form

set 16:UNT=ft<CR><LF>

the value of all range dependent parameters in the protocol responses is changed from the default meters (m) to feet (ft) scale. Since Unit(m/ft) belongs to the changeable parameters, it should be confirmed with

<STX>set 16:Unit(m/ft)=ft;2A<CR><LF><EOT>

The value 2A is the checksum of the response line.

Example for an alphanumeric value that exceeds the parameter length:

A 37 character long value will be cut to the first 31 characters that will be used by the system:

set 16:Location=123456789-123456789-123456789-1234567<CR><LF>
System response:

<STX>set 16:Location=123456789-123456789-123456789-1;CD<STX>

8.2.3 Changing the baud rate

The option to change the baud rate is a specific feature. The change takes place as described in 8.2.2 Setting a parameter. Thus, baud rate no. 4 that corresponds to 19,200 bits/s, is set with

set<SPACE><RNO>:Baud=4<CR><LF>

The correlation between baud rate # and baud rate is shown in Table 6.

Baud rate #	Baud rate [bit/s]
(0)	(1,200)
(1)	(2,400)
2	4,800
3	9,600
4	19,200
5	38,400
6	57,600
7	115,200

Table 6 Correlation between baud rate # and baud rate.

Baud rates 0 and 1 are not specified within the time limit. After sending a set command, the interface is immediately set to the new baud rate. An incorrectly set baud rate will lead to transmission errors afterwards and would make a normal reset impossible because of the lack of communication capability. After expiry of the time interval specified in TimeOutRS485 (default value: 30 s), the incorrect baud rate is reset to the baud rate defined in the parameter BaudAfterError. This guarantees that the user can regain control of the device after this waiting period. The default value of BaudAfterError is 3, which corresponds to 9,600 bits / second. The default value should be modified by the user, too, in case a baud rate of e.g. 19,200 is always used.

8.2.4 Restarting the embedded Linux system / factory settings

The command

```
set<SPACE><RS485Number>:Reset=1<CR><LF>
```

instructs the internal processor to perform an immediate restart. This restart takes less than one minute. Communication with the CHM 8k is not possible during this time; any current automatic telegram output is also interrupted.

The command

```
set<SPACE><RS485Number>:ResetSettings=1<CR><LF>
```

resets all parameters to the factory settings.

The command RSN restarts the network. A restart is always necessary if the network settings, e.g. IP address, DHCP mode, etc., have been changed. The new network settings are only used after entering the commands RSN or RST.

```
set<SPACE><RS485Number>:RSN=1<CR><LF>
```

8.2.5 Changing the time settings

```
set<SPACE><RS485Number>:dts=30<CR><LF>
```

The logging and reporting time are set to 30 seconds. The internal measuring time is always set to one second. The login and reporting time must be a multiple of one second.

The command

```
set<SPACE><RS485Number>:DateTime=DD.MM.YYYY;hh:mm:ss<CR><LF>
```

is used to change the date and time of the embedded system. Here, DD = day, MM = month and YYYY = year, hh = hour, mm = minute and ss = second according to time zone GMT (Greenwich Mean Time).

Example with RS485Number = 16:

```
set 16:DateTime=13.04.2006;17:22:46<CR><LF>
```

sets the date to 13.04.2006 and the time to 17:22:46 GMT.

8.3 Data query RS485

When running, the CHM 8k operates in one of the transfer modes shown in Table 7.

Transfer mode	Description
0	Data telegrams are only output on a specific request (polling mode)
1	Automatic output of the standard data telegram
2	Automatic output of the extended data telegram
3	Automatic output of the raw data telegram
4 ... 9	Automatic output of further predefined data telegrams

Table 7 Summary of transfer modes.

The transfer mode can be changed with the Set command

```
Set<SPACE> <RS485Number>:TMO=<Transfermode>
```

as described in section 8.2.2 Setting a parameter or via direct input in the web interface.

Thus, with the command

```
set<SPACE>16:TransferMode=1<CR><LF>
```

the automatic output of the standard data telegram is activated for the device with RS485 number 16 (default setting valid at the time of delivery).

8.3.1 Polling mode

The command

set<SPACE><RS485Number>:TransferMode=0<CR><LF>

sets the polling mode and thereby any previously running automatic telegram output is issued. With the three commands

get<SPACE><RS485Number>:S<CR><LF>

get<SPACE><RS485Number>:L<CR><LF>

get<SPACE><RS485Number>:A<CR><LF>

the standard data telegram (S), extended data telegram (L) or raw data telegram (A) are called up once only. For the format of the respective data telegram, see section 8.3.3 to 8.3.5 (Table 8, Table 9, Table 12).



Further telegrams

The hardware of the CHM 8k supports further user telegrams.

In addition to the characters {S, L, A}, numbers are also supported. With S = 1, L = 2, A = 3, the first three numbers are predefined.

8.3.2 Automatic output mode

With the command

set<SPACE><RS485Number>:TransferMode=1<CR><LF>

the automatic mode is set with a standard telegram output. Its repetition rate depends on variable dt(s) that is set to 15 seconds by default.

Table 8 contains the format of the standard data telegram.

The output of the extended data telegram is set with the command

set<SPACE><RS485Number>:TransferMode=2<CR><LF>

Table 9 contains the format of the extended data telegram.

The raw data telegram is output via the following command:

set<SPACE><RS485Number>:TransferMode=3<CR><LF>

Table 12 contains the format of the raw data telegram.



Transfer modes 4 ... 9

The transfer modes 4 ... 9 are additional predefined data telegrams.

8.3.3 Standard data telegram

The standard data telegram consists of 96 bytes. The data is separated by spaces (20 HEX). Table 8 shows details of the format structure.

Byte	Value	Description
0	<STX>	02 HEX
1	X	
2	1	
3, 4	TA	
5	<SPACE>	20 HEX
6	8	
7	<SPACE>	20 HEX
8-10	***	Output interval [s]
11	<SPACE>	20 HEX
12-19	** ** **	Date (DD.MM.YY)
20	<SPACE>	20 HEX

Byte	Value	Description
21-25	** **	Time (hh:mm)
26	<SPACE>	20 HEX
27-31	*****	Cloud layer 1
32	<SPACE>	20 HEX
33-37	*****	Cloud layer 2
38	<SPACE>	20 HEX
39-43	*****	Cloud layer 3
44	<SPACE>	20 HEX
45-48	****	Penetration depth of the laser beam in cloud layer 1
49	<SPACE>	20 HEX
50-53	****	Penetration depth of the laser beam in cloud layer 2
54	<SPACE>	20 HEX
55-58	****	Penetration depth of the laser beam in cloud layer 3
59	<SPACE>	20 HEX
60-64	*****	Vertical visibility
65	<SPACE>	20 HEX
66-70	*****	Maximum detection range
71	<SPACE>	20 HEX
72-75	****	Cloud height offset (zero or altitude, depending on usealtitude)
76	<SPACE>	20 HEX
77, 78	**	Unit (ft/m), ft or m<SPACE>
79	<SPACE>	20 HEX
80, 81	**	Sky condition index
82	<SPACE>	20 HEX
83-90	*****	System status: 32 Bit status code
91	<SPACE>	20 HEX
92, 93	**	Checksum (two's complement of the sum of bytes 0 to 96 expressed in hex code, excluding bytes 92 and 93)
94	<CR>	0D HEX
95	<LF>	0A HEX
96	<EOT>	04 HEX

Table 8 Standard data telegram format; * = any character.

Up to three cloud bases are reported in the standard telegram. If less than three cloud bases are detected, the text **NODET** appears in the remaining fields. If cloud penetration depths are not determined, the text **NODT** appears in the corresponding fields.

A **NODET** value is also reported in the protocol if the algorithm is unable to calculate the following values:

- Visibility
- Maximum detection range

Measured values that are exceeding the given field length, for example "12345" for a four-digit field, the field is filled with "?". With the exception of the cloud penetration depth values, these are displayed as "9999" if they exceed the length.

If the values cannot be determined due to a device error, the fields are filled with a minus sign "-" or a slash "/" (see section 8.4.5). Detailed information on the type of device error can be found in the status codes (see section 8.5).



Correction of the measured cloud height

The cloud height is usually measured from the bottom of the device. With the parameter "usealtitude" you can control whether the cloud heights are corrected by the value

Byte	Value	Description
90	;	3B HEX
91-98	*****	System status: 32 Bit status code
99	;	3B HEX
100-101	**	RS485 identification number CHM 8k in the RS485 bus system, error is 16
102	;	3B HEX
103-111	CHMYYNnnn	Device name (FabName) (YY for year, nnnn for serial number)
112	;	3B HEX
113-117	*****	Standard deviation cloud layer 1 (CBE)
118	;	3B HEX
119-123	*****	Standard deviation cloud layer 2 (CBE)
124	;	3B HEX
125-129	*****	Standard deviation cloud layer 3 (CBE)
130	;	3B HEX
131-134	****	Standard deviation penetration depth of laser beam in cloud layer 1 (CDE)
135	;	3B HEX
136-139	****	Standard deviation penetration depth of laser beam in cloud layer 2 (CDE)
140	;	3B HEX
141-144	****	Standard deviation penetration depth of laser beam in cloud layer 3 (CDE)
145	;	3B HEX
146-150	*****	Standard deviation vertical visibility (VOE)
151	;	3B HEX
152-155	****	Software version FPGA
156	;	3B HEX
157-160	****	Software version for signal processing OMAP
161	;	3B HEX
162-163	**	System status: "OK" or "ER"
164	;	3B HEX
165-168	****	Outside temperature (Kelvin x 10)
169	;	3B HEX
170-173	****	Inside temperature (Kelvin x 10)
174	;	3B HEX
175-178	****	Detector temperature (Kelvin x 10)
179	;	3B HEX
180-183	****	Detector control voltage (Volts x 10)
184	;	3B HEX
185-188	****	Test pulse height
189	;	3B HEX
190-195	*****	Laser operating hours (h)
196	;	3B HEX
197-199	***	Window status
200	;	3B HEX
201-205	*****	Laser frequency (PRF) (5 digits)
206	;	3B HEX
207-209	***	Receiver status

Byte	Value	Description
210	;	3B HEX
211-213	***	Laser status
214	;	3B HEX
215-219	*****	Aerosol layer 1
220	;	3B HEX
221-225	*****	Aerosol layer 2
226	;	3B HEX
227	*	Quality index aerosol layer 1
228	;	3B HEX
229	*	Quality index aerosol layer 2
230	;	3B HEX
231	*	BCC; Base Cloud Cover
232	;	3B HEX
233	*	TCC; Total Cloud Cover
234	;	3B HEX
235-236	**	Checksum (two's complement of the sum of bytes 0 to 239 expressed in hex code, excluding bytes 235 and 236)
237	<CR>	0D HEX
238	<LF>	0A HEX
239	<EOT>	04 HEX

Table 9 Extended data telegram format (see also Table 10); * = any character.

For the stated standard deviations of the individual quantities, the same exception values apply as for the corresponding basic quantities (see sections 8.3.3 and 8.4.5): "NODET/NODT/---", "?" resp. "9999" in case of over-length of the deviation of the penetration depth.



Further system parameters

The system parameters for data evaluation, including penetration depth, are explained in section 9 Data Evaluation / Sky Condition Algorithm (SCA).

Designation	Description
Outside temperature	The measured outdoor temperature at the bottom of the unit. The measured values are displayed in Kelvin x 10. Error tolerance ± 5 K
Inside temperature	Measured temperature at the sensor. The measured values are displayed in Kelvin x 10. Error tolerance ± 2 K
Detector temperature	Measured temperature at the sensor. The measured values are displayed in Kelvin x 10. Error tolerance ± 2 K
NN1	Not used
NN2	Not used
Laser operating hours (h)	Operating time of the laser in hours
Optics status	Degree of contamination of the glass window in percent 100 = clear view, 0 = opaque
Laser pulse number	Number of laser pulses in the measuring interval (7 digits)

Receiver status	Evaluation of the status of the optical path and receiver 100 = maximum sensitivity 0 = no sensitivity
Light source status	Evaluation of the lifetime and stability of the laser

Table 10 Designations in the extended data telegram.

8.3.5 Raw data telegram

The raw data is output in NetCDF format (for a description see 8.4 Structure of the NetCDF format). NetCDF is a binary format. For transmission via RS485 / RS232, a transmission in a 7-bit ASCII code (range 21 to 60 HEX) with UUencode is required to be able to handle none printable characters such as <STX> or <EOT>.

The size of the NetCDF file of a raw data set is approximately 14 KByte. The UUencode conversion produces 20 KByte of ASCII data which has to be transferred. At a baud rate of 9,600 bit/s, the transmission takes about 16 seconds. The automatic output of the raw data telegram is restricted to specific logging time / Baud rate combinations, as set out in Table 11 below.

Baud rate no.	Baud rate [bit/s]	Logging time interval [dt(s)]
0	1,200	Not possible
1	2,400	Not possible
2	4,800	≥ 40 s
3	9,600	≥ 20 s
4	19,200	≥ 10 s
5	38,400	≥ 5 s
6	57,600	No further restrictions
7	115,200	No further restrictions

Table 11 Baud rate – logging time restrictions.

Table 12 describes the structure of the additional data of the raw data telegram.

Byte	Value	Description
0-238		Exactly as in the extended data telegram (for 3 cloud layers)
239	<CR>	0D HEX
240	<LF>	0A HEX
241-(eeee-5)		Raw data in ASCII format (UUencode)
eeee-4 eeee-3	**	Checksum (two's complement of the sum of bytes 0 to eeee, excluding bytes eeee-4 and eeee-3, expressed in Hex code)
eeee-2	<CR>	0D HEX
eeee-1	<LF>	0A HEX
eeee	<EOT>	04 HEX

Table 12 Raw data telegram format; * = any character.

The lines with the raw data have the following structure according to UUencode standard:

Line 1:

begin 644 YYYYMMDDhhmmss_[Location]_[Device ID].nc<CR><LF>

Line 2:

M*****<CR><LF>

Line 3:

M*****<CR><LF>

...

Line (n-2):

```

M*****<CR><LF>
Line (n-1):
E***** **<CR><LF>
Line n:
end<CR><LF>

```

The * character indicates a UUencode ASCII character in the range HEX 21-60.

The "M" (HEX 4D) at the beginning of the data lines stands for the likewise UUencoded number of data bytes in this line:

- 4D decoded corresponds to the number HEX 2D = 45 decimal.

According to 4/3 UUencode conversion, these 45 bytes are encoded into 60 ($60 = 45/3 \times 4$) ASCII characters, which follow "M". The last line is an exception, as the last bytes, which are generally less than 45, are encoded.

The above example shows "E" (HEX 45, decoded HEX 25 = 37 decimal), hence a further 37 bytes of raw data follow. As a result of the 4/3-encoding, however, this becomes 52 ASCII characters (rounded up to a multiple of 4 characters) ($52 = (37/3 \text{ rounded}) \times 4$).

The last line with "end" marks the completion of the UUencode data.

Example for the file name in Line 1:

YYYYMMDDhhmmss_ [Location]_[DeviceID].nc

e.g. 20190108123730_Berlin_CHM198001.nc (see also section 8.4.3)

This means:

- Device CHM198001 in Berlin, data for 08.01.2019, 12:37:30.

8.3.6 Additional data telegrams

The structure of the data telegrams is defined in the file "telegramformat.xml". The file can be downloaded via the web interface in superuser mode. It can be modified and uploaded again. Please pay attention to the note on page 54 in the section 8.7.3.

Some user telegrams are already pre-defined in the firmware:

- Telegram 4: Telegram 2 + fan and heating status + 8 comment fields (COM to CM7). The length of the telegram is variable, because the comments only take up the space that their length requires.
- Telegram 5: Telegram 1 + fan and heating status
- Telegram 6: CL31 data telegram 1 from Vaisala
- Telegram 7: CL31 data telegram 2 from Vaisala
- Telegram 8: CT25k data telegram 1 from Vaisala
- Telegram 9: CT25k data telegram 6 from Vaisala

A separate description is available for the predefined user telegrams. These telegrams can change.

8.4 Structure of the NetCDF format

8.4.1 General

The ceilometer saves all measured backscatter profiles in a daily file in the NetCDF format (Network Common Data File). The storage capacity of the internal 8 GB SD card allows files to be kept on record for approximately one year. The files can be accessed via web interface (LAN connection). If the communication to the device was interrupted due to a fault, affected data thus can be inspected and traced back. In addition, the raw data of a single measurement can be called up as a raw data telegram via the RS485 or LAN interface. The operation does not include the transmission of more than a single measurement via RS485, since this would negatively influence the time sequencing in this mode. Because the transmission rate depends on the time resolution of the measured data and the RS485 interface settings, this transmission would take too long. A one-day NetCDF file with $dt(s)=15s$ measurement time intervals will be approximately 17 MB in size. For the LAN interface a direct access to the daily files, to 5 min files (AFD (ftp) mode) and single files via request is possible.

8.4.2 Basic principles

NetCDF provides a computer-platform independent interface for storing and reading scientific data. It was developed by Unidata, a project funded by the National Science Foundation (<http://www.unidata.ucar.edu>). Each record contains explanations of the stored content.

The ceilometer stores all the data for one day in a file or in case the AFD mode is active in 5 min files. The time used is UTC. In the standard mode (RS485), the CHM 8k transmits a raw data telegram with a single backscatter profile and all descriptive variables and attributes in the NetCDF format. The raw data telegrams for one day can be merged into a day file.

8.4.3 File names

Day file: YYYYYMMDD_[Location]_[DeviceID]_[Index].nc
 Raw data in RS485 telegram: YYYYYMMDDhhmmss_[Location]_[DeviceID].nc
 Raw data with 5-minute time resolution for AFD mode (ftp) YYYYYMMDD_[Location]_[DeviceID]_hhmm_Index.nc



Length of data file names

For problem-free file transfer, the ISO standards should be complied with in their extended form. The file length should not exceed 31 characters. For the structure of the day files with [Date]_[Location]_[DeviceID]_[Index].nc (8_5_9_3.2=31 characters), this means that the variable "location" must have less than 6 characters.

8.4.4 Format structure

In the NetCDF format, the values to be stored are defined and stored by dimensions, variables and attributes. Table 13 to Table 15 describe the designations used.

Dimensions

Dimension	Description	Standard
time	Number of measured backscatter profiles within a NetCDF file	UNLIMITED
range	Number of points measured and stored in backscatter profiles in the NetCDF format with a resolution of 15 m.	667
range_hr	Number of points stored in the high-resolution NetCDF backscatter profile with a resolution of 5 m	32
layer	Number of cloud layers transmitted in telegrams and stored in NetCDF files	3

Table 13 Dimensions in NetCDF.

Global attributes

Attribute	Description	Type
title	Heading for graphical representation, e.g. "Lufft Berlin, CHM 8k"	text
source	See device_name (left for compatibility reasons)	text
device_name	Serial number, device name of the instrument	text
serlom	Serial number of the measuring unit, e.g. "TUB198001"	text

day	Day of the month, on which the data was recorded	int
month	Month as a number, January = 1,...	int
year	Year, in which the data were recorded: e.g. 2019	int
location*	Location / site of measurement	text
institution*	Institution or company	text
wmo_id*	WMO station ID	int
wigos_id*	WIGOS station identifier	text
netcdf_mode	Identification of the NetCDF format (1 .. beta_att)	int
software_version	Linux kernel, FPGA software, Firmware, CloudDetectionMode	text
comment*	Any descriptive comment	text
overlap_file	Name / time of the overlap correction function used to generate the beta variables	text

Table 14 Global attributes in NetCDF.

* User-defined settings

Variables

Variable	Type	Dim.	Unit	Long description	Scaling
time	double	time	seconds since 1904-01-01 00:00:00.000 00:00	End time of measurement (UTC)*	
range	float	range	m	Distance from device (independent of direction and height of installation site)*	
range_hr	float	range_hr	m	Distance from device for high-resolution data*	
layer	int	layer		Index of layers	
latitude	float		degrees_north	Latitude of installation site	
longitude	float		degree	Longitude of installation site	
azimuth	float		degree	Azimuth angle of device (laser direction)	
zenith	float		degree	Zenith angle of device (laser direction)	
altitude	float		m	Altitude of ceilometer above mean sea level	
wavelength	float		nm	Laser wavelength in nm	
average_time	int		ms	Averaging time per record	
range_gate	float		m	Range resolution of data	
range_gate_hr	float		m	Range resolution of high- resolution data	
life_time	int	time	h	Laser operating hours	
error_ext	int	time		32-bit status code	

Variables

Variable	Type	Dim.	Unit	Long description	Scaling
state_laser	byte	time	percent	Laser quality index	
state_detector	byte	time	percent	Quality of detector signal	
state_optics	byte	time	percent	Optical quality index	
temp_int	short	time	K	Internal temperature	0.1
temp_ext	short	time	K	External temperature	0.1
temp_det	short	time	K	Detector temperature	0.1
temp_lom	short	time	K	Temperatur of laser optic module	0.1
temp_las	short	time	K	Laser temperature	0.1
humidity	short	time	percent	Humidity (at main controller)	0.1
laser_pulses	int	time		Number of laser pulses averaged per record (lp)	
laser_power	short	time	mW	Laser output power (l)	0.001
p_window	short	time		Window reflex	0.01
p_cal	short	time		Calibration pulse (for normalization of detection sensitivity over time)	0.01
p_ref	short	time		Calibration pulse (PIN detector; for normalization of detection sensitivity over time)	0.01
c_cal	float			Calibration constant (c)	
scaling	float			Scaling factor (for normalization of measuring units with respect to each other) (cs)	
base	float	time		Baseline height of raw signal (mainly influenced by background light) (b)	
stddev	float	time		Standard deviation raw signal	
beta_att	float	time range	1/m * 1/sr	Attenuated backscatter $\frac{(P_{raw} / lp) - b}{(cs * o(r) * p_{cal}/p_{ref} * l) * r * r * c}$ with $P_{raw} = \sum(P_{raw_hr} * range_gate_hr / range_gate)$	
beta_att_hr	float	time range_hr	1/m * 1/sr	Attenuated backscatter (high resolution) $(P_{raw_hr} / lp - b) / (cs * o(r) * p_{cal}/p_{ref} * l) * r * r * c$	
pbl	short	time layer	m	Aerosol layers	
pbs	byte	time layer		Quality score for aerosol layers (1: good, ..., 9: bad)	

Variables

Variable	Type	Dim.	Unit	Long description	Scaling
tcc	byte	time		Total cloud cover	
bcc	byte	time		Base cloud cover	
sci	byte	time		Sky condition index (0: no precipitation, 1: rain, 2: fog, 3: snow, 4: precipitation or particles on window)	
vor	short	time	m	Vertical optical range	
voe	short	time	m	Vertical optical range error	
mxd	short	time	m	Maximum detection height	
cbh	short	time layer	m	Cloud base height	
cbe	short	time layer	m	Cloud base height variation	
cdp	short	time layer	m	Cloud depth	
cde	short	time layer	m	Cloud depth variation	
cho	short		m	Height offset (used in cbh, mxd, vor and pbl; corresponds to altitude if usealtitude=1, otherwise 0)	
voltage_dc	short	time	V	Mainboard supply voltage	0.001
voltage_det	short	time	V	Detector high voltage	0.1
voltage_las	short	time	V	Laser bias voltage	0.001
voltage_led	short	time	V	Reference LED bias voltage	0.001
background_det	short	time	mV	Detector background signal	
Fan	short	time		Fan activity (bit 0 set = window fan on, bit 1 set = mainboard fan on)	
nn1	short	time		nn1	
nn2	short	time		nn2	

Table 15 Variables in the NetCDF file.

*time: corresponds to the end time of each measurement period (average_time)

range: corresponds to the start of each distance interval (range_gate, range_gate_hr)

8.4.5 Special values of the evaluation parameters

If evaluation parameters determined by evaluating the backscatter signal cannot be determined, various special values are written to the corresponding NetCDF variable depending on the cause of the non-determination. This applies to the NetCDF variables cbh, cbe, cdb, cde, mxd, pbl, pbs, bcc, tcc, vor, voe, sci and state_optics. Table 16 shows the general meaning of the special values. In deviation from this, there is only the value -2 for the variables sci and state_optics. The slightly different meaning of the special values for bcc, tcc and pbs is given in Table 21 and Table 22.

In the standard telegrams, the special values are represented by the characters specified in Table 16 Column 2. Which of the respective variants is used depends on the number of digits of the evaluation parameter in the telegram.

Special value	Telegram	Description
-1	NODET, NDET, //, /	The evaluation parameter was not found in the signal, for example no cloud base height with clear sky.
-2	-----, ----, --, -	There is a hardware error. No data evaluation is performed, i.e., no evaluation parameters are determined.
-3	NODET, NDET, //, /	Due to the algorithm, no value could be determined, for example if not enough raw data is available for a calculation.

Table 16 Special values of the evaluation parameters.

8.5 Status code

There are two different status code variants, each of which reflects the device status as a 32-bit number. Table 17 lists the meanings of the individual bits of the status codes, which are known from the CHM 15k. This status code variant is output in the web interface and in the NetCDF data. In the data telegrams, the escalated status codes described in section 8.5.1 are output by default, for example characters 83 ... 90 in the standard telegram, or characters 91 ... 98 in the extended data telegram (refer to Table 8 and Table 9). With the setting SystemStatusMode (SSM) you can switch between the output of the two variants in the telegrams.

The status codes output in the web interface and the NetCDF files are represented as an eight-digit hexadecimal number, which is composed of the 32 bits. Bits that are not set mean that the corresponding part is running properly. Set bits indicate errors / warnings / information or initializations that are still running, e.g. shortly after power-on.

Bit	Hex	Type	Error description
0	00000001	Error	Error: Signal quality
1	00000002	Error	Error: Signal recording
2	00000004	Error	Error: Signal values null or void
3	00000008	Error	Error: Mainboard detection failed (APD bias) or firmware and CPU do not match
4	00000010	Error	Error: Create new NetCDF file
5	00000020	Error	Error: Write / add to NetCDF error
6	00000040	Error	Error: RS485 telegram can not be generated and transmitted
7	00000080	Error	Error: SD card absent or defective
8	00000100	Error	Error: Hardware failed or cable absent or defective
9	00000200	Warning	Warning: Inner housing temperature out of range
10	00000400	Error	Error: Laser optical unit temperature error
11	00000800	Error	Unused
12	00001000	Note	Note: NTP problem
13	00002000	Error	Error: Laser disabled (related to temperature or laser safety)
14	00004000	Error	Error: Laser power or PIN signal too low or saturated
15	00008000	Warning	Warning: Replace laser - ageing

Bit	Hex	Type	Error description
16	00010000	Warning	Unused
17	00020000	Warning	Warning: Windows contaminated
18	00040000	Warning	Warning: Signal processing
19	00080000	Warning	Warning: Laser detector misaligned or receiver window soiled
20	00100000	Warning	Warning: File system, fcsk repaired bad sectors
21	00200000	Warning	Warning: RS485 baud rate / transfer mode reset
22	00400000	Warning	Warning: AFD problem
23	00800000	Warning	Warning: Configuration problem
24	01000000	Warning	Warning: Laser optical unit temperature
25	02000000	Warning	Warning: External temperature
26	04000000	Warning	Warning: Laser temperature out of range
27	08000000	Note	Note: High humidity inside the device
28	10000000	Note	Note: Number of layers > 3 and telegram selected
29	20000000	Note	Note: Device was started
30	40000000	Note	Note: Standby mode on

Table 17 Status codes / status bits.

The unused bits are set to 0 by default so that the hexadecimal status code 0 indicates the full operational readiness of the CHM 8k.

8.5.1 Escalated status codes

The CHM 8k offers an additional status code. It is divided into the following eight groups:

1. Configuration
2. Data transmission and storage
3. Temperatures
4. Calculation / processing in sky condition algorithm
5. Laser and LED test pulse
6. Main detector and PIN detector
7. Window contamination sensor and laser monitor
8. Voltages and fans

Each group is assigned a position in the hex representation of the 32-bit status code. For example, information, warnings and errors relating to temperatures (group 3) are in the third place from the right, i.e. xxxTx.

In each group, only the highest priority error, the highest error code in the status code, is displayed. With the setting *SystemStatusMode (SSM)* the user can define, which status code variants for the telegram output should be used. For the CHM 8k the escalated status code is used by default.

Table 17 describes the meaning and lifetime of the individual status codes.

Group	Hex code	Error description	Duration [s]
1	Configuration		
	xxxx xxx0	Setup works correctly	

Group	Hex code	Error description	Duration [s]
	xxxx xxx1	Restart after reboot or firmware restart (SW)	60
	xxxx xxx2	Restart after shutdown	60
	xxxx xxx3	Restart after watchdog triggered (FW)	60
	xxxx xxx4	Restart (e.g. after power failure, HW watchdog)	60
	xxxx xxx5	Device running in standby	delete
	xxxx xxx6	Invalid parameter, previous or corrected configuration is used	300
	xxxx xxx7	Unknown NetCDF format identifier in settings file	60
	xxxx xxx8	Number of layers too large for telegram 1	60
	xxxx xxx9	Dimensions do not match	∞
	xxxx xxxA	No valid overlap file found	∞
	xxxx xxxB	EEPROM defective / not available or cable defective	16
	xxxx xxxC	Mainboard identifier cannot be read	∞
	xxxx xxxD	Firmware does not match the CPU version	∞
2 Data transmission and storage			
	xxxx xx0x	Data transmission and storage working properly	
	xxxx xx1x	Faulty FAT file system on SD card repaired	60
	xxxx xx2x	NTP problem	60
	xxxx xx3x	RS485 baud rate / transfer mode were reset	60
	xxxx xx4x	AFD problem	60
	xxxx xx5x	Data telegram cannot be transmitted	16
	xxxx xx6x	Data telegram cannot be generated	16
	xxxx xx7x	Write error in NetCDF file	60
	xxxx xx8x	New NetCDF file cannot be generated	60
	xxxx xx9x	SD card not available or defective	∞
3 Temperatures			
	xxxx x0xx	Temperature values are in range	
	xxxx x2xx	Laser temperature outside the valid range (setpoint -3°C ... setpoint +3°C)	60
	xxxx x3xx	Laser optical module (LOM) temperature out of the valid range (25 °C ... 49 °C)	60
	xxxx x4xx	Internal temperature out of the valid range (5°C...65°C)	16
	xxxx x5xx	External temperature out of the valid range (-40°C...60°C)	60
	xxxx x6xx	Laser optical unit temperature control disabled due to safety reasons	∞
	xxxx x9xx	Laser optical unit temperature too high	16
	xxxx xAxx	Laser temperature outside the operating range or invalid	delete

Group	Hex code	Error description	Duration [s]
4	Calculation / processing in sky condition algorithm		
	xxxx 0xxx	Data processing OK	
	xxxx 1xxx	Problem in calculating the visual range	60
	xxxx 2xxx	Problem in calculating of aerosol layers	60
	xxxx 3xxx	Problem in calculating of cloud coverage	60
	xxxx 4xxx	Problem in calculating of clouds	60
	xxxx 5xxx	Abnormal signal	60
	xxxx 6xxx	Incorrect dimensioning of raw data	16
	xxxx 7xxx	No new data	16
5	Laser and LED test pulse		
	xxx0 xxxx	Laser and LED test pulse working normally	
	xxx2 xxxx	LED test pulse less than or equal to zero	16
	xxx3 xxxx	Replace laser (ageing)	60
	xxx6 xxxx	Laser shut down for safety reasons	delete
	xxx7 xxxx	Laser disabled (hardware-side); reset possible	16
	xxx8 xxxx	Laser not ready (temporary intermediate state)	16
	xxx9 xxxx	Laser disabled (hardware-side); need restart	16
6	Main detector and PIN detector		
	xx0x xxxx	Main receiver and PIN receiver working normally	
	xx2x xxxx	Laser detector misaligned, or receiver window soiled	60
	xx3x xxxx	PIN signal saturated	60
	xx4x xxxx	Calculated PIN signal not positive, resulting in incorrect calibration	60
	xx5x xxxx	PIN signal too low	60
	xx6x xxxx	Values from detector signal zero or void	16
	xx7x xxxx	Insufficient test pulse signal available	16
	xx8x xxxx	No window pulse in receiver signal	16
	xxAx xxxx	No receiver signal in the measuring range [150m, 250m]	16
	xxBx xxxx	No receiver signal	16
	xxCx xxxx	No test pulse signal on the receivers (RefLED SMC cable?)	16
	xxEx xxxx	No receiver signal (power supply cable?)	16
	xxFx xxxx	No receiver signal (signal cable?)	16
7	Window contamination sensor, humidity, and laser monitor		
	x0xx xxxx	Window contamination sensor, humidity, and laser monitor OK	

Group	Hex code	Error description	Duration [s]
	x1xx xxxx	High humidity inside the device	16
	x2xx xxxx	Humidity inside the device too high	16
	x3xx xxxx	Window contaminated	60
	x4xx xxxx	Laser monitor signal saturated	60
	x5xx xxxx	Detected laser power not positive, resulting in incorrect calibration	60
	x6xx xxxx	Laser monitor signal too low	60
8 Voltages and fans			
	0xxx xxxx	Voltages and fans OK	
	1xxx xxxx	Mainboard fan is slow	delete
	2xxx xxxx	Mainboard fan not working	delete
	5xxx xxxx	Test pulse voltage is faulty	16
	6xxx xxxx	PIN detector voltage is faulty	16
	7xxx xxxx	Main detector voltage is faulty	16
	8xxx xxxx	Laser voltage is faulty	16
	9xxx xxxx	Analog supply voltage is faulty (+/- 5V)	16
	Axxx xxxx	Mainboard voltage is faulty (5.1 V)	16
	Bxxx xxxx	Mainboard supply voltage is faulty (12 V)	16

Table 18 Escalated status codes (HW: Hardware, SW: Software, FW: Firmware), *delete: error is shown until fault condition is removed.

Meaning of colors:	
	All OK
	Information
	Warning
	Error

8.6 Firmware update

The system software of the CHM 8k can be updated via an Ethernet interface (WAN / LAN connection). The software update functionality is available as super user and is provided in the tab “Config System” of the web interface. Please consult the following section 8.7 Communication via Ethernet web interface for details. Since firmware 1.110 the firmware can only be updated. A downgrade functionality has been disabled as configuration files are not compatible any longer to older firmware releases.

8.7 Communication via the web interface (Ethernet)

8.7.1 Device overview and access rights (Device tab)



Figure 15 Web interface.

Figure 15 shows the start screen ("Device" tab) after successful connection with the device (for startup see 7.2). This screen shows information about the current status of the device and the user can log in as a superuser or service user is possible.

Communication with the CHM 8k via an Ethernet connection is fast, secure and system-independent. An Apache web server runs inside the device. This enables a communication and configuration platform via the web interface for processing firmware updates, quick previews of measurement results or downloading full-day NetCDF raw data.

In general, the web interface contains the following access rights:

- End users can check the status of the instrument.
- Superusers can additionally download NetCDF files, configure the device, download the user manual as well as other configuration files, update the firmware, and switch off or restart the device.
- Service users can set additional system parameters, for example, the serial number of the device (see Table 4), upload critical configuration files and reset the superuser password.

The status information on the device tab and the content in the process status tab are updated every minute. The listed status information codes correspond to the status codes in Table 17 and the status provided in data telegrams via RS485 interface. The process status (Figure 23) provides additional information for the Lufft service personnel.

In superuser or service mode, the start page contains buttons to switch the device off or to initiate a reset.

8.7.2 Access to measurement data (NetCDF files, viewer)

Figure 16 shows the directory of NetCDF files that are visible to all users. In superuser or service mode, these NetCDF files can be downloaded by clicking on the file name.

Device	Viewer	NetCDF Files	Config System	Config Network	Config RS485	Process Status	?						
<p>Count: 47 Update List</p> <table border="1"> <thead> <tr> <th>File Name</th> <th>Size [kB]</th> </tr> </thead> <tbody> <tr> <td>20190930_Berlin_CHM188104_000.nc</td> <td>3918</td> </tr> <tr> <td>20190929_Berlin_CHM188104_000.nc</td> <td>12581</td> </tr> </tbody> </table>							File Name	Size [kB]	20190930_Berlin_CHM188104_000.nc	3918	20190929_Berlin_CHM188104_000.nc	12581	
File Name	Size [kB]												
20190930_Berlin_CHM188104_000.nc	3918												
20190929_Berlin_CHM188104_000.nc	12581												

Figure 16 Web interface: NetCDF files.

Figure 17 shows the content of the "Viewer" tab, displaying the existing data for the last 24 hours. Clicking the "Update" button updates the image file, however this can only be done every 5 minutes. The "BackscatterMax" parameter in the "Config System" tab (Figure 20) can be changed to easily adjust the color scale. The currently detected clouds are updated in the interval dt(s) and displayed together with aerosol layers and cloud cover in the table above the image.

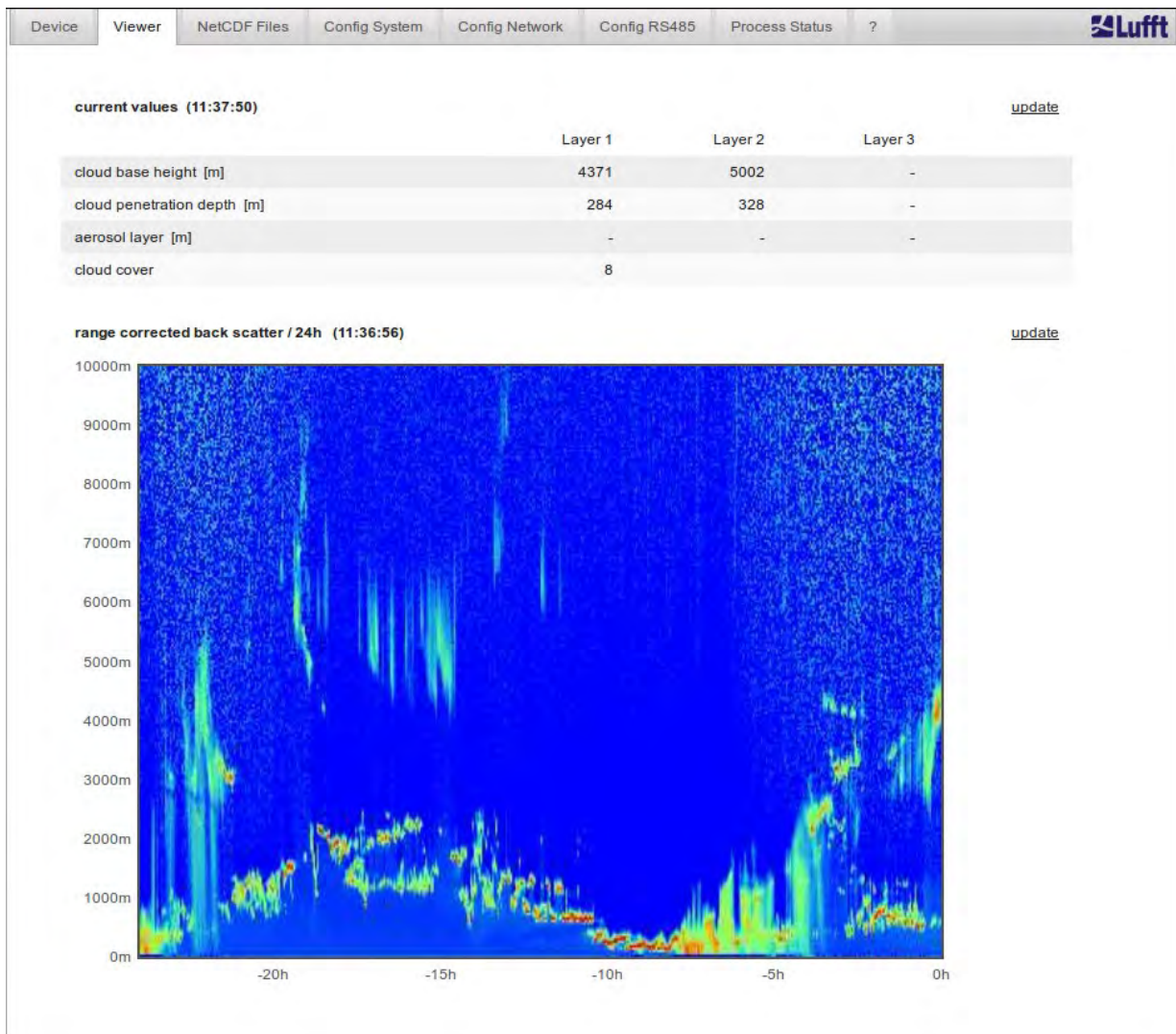

Figure 17 Web interface: Viewer.

8.7.3 Configuring the CHM 8k (Config tab)

The contents of the configuration pages ("Config System", "Config Network" and "Config RS485") are only accessible to superusers and service users. The parameters can also be set via RS485 communication and are described in section 8.1 List of configurable parameters.

Name	Address	Netmask
eth0.2 (dhcp)		
eth0:1 (custom)	10.130.65.120	255.255.255.0
eth0 (fix)	192.168.100.101	255.255.255.0
gateways	10.130.65.2	
ntp server	192.53.103.104	

[update](#)

Figure 18 Web interface: Config Network (read-only, default mode) for a device with configured static IP (eth0:1 custom).

Name	Address	Netmask
eth0.2 (dhcp)		
eth0:1 (custom)	10.130.65.120	255.255.255.0
eth0 (fix)	192.168.100.101	255.255.255.0
gateways	10.130.65.2	
ntp server	192.53.103.104	

[update](#)

Network Configuration

DhcpMode	0	<input type="text"/>	set
IPAddress	10.130.65.120	<input type="text"/>	set
Netmask	255.255.255.0	<input type="text"/>	set
Gateway	10.130.65.2	<input type="text"/>	set
DnsServer		<input type="text"/>	set

[restart network](#)

NtpMode	1	<input type="text"/>	set
NtpServer	192.53.103.104	<input type="text"/>	set
LanTelegramNumber	2	<input type="text"/>	set
LanTransferMode	1	<input type="text"/>	set
LanPort	11000	<input type="text"/>	set
HttpPort	80	<input type="text"/>	set

AFD Configuration

AfdMode	1	<input type="text"/>	set
---------	---	----------------------	---------------------

[Download AFD dir_config](#)

Upload new AFD dir_config:

No file selected.

Figure 19 Web interface: Config Network (superuser).

Figure 18 shows the "Config Network" tab of a device with static IP in the default user view. The static IP address (eth0: 1 custom), netmask, and gateway can be adjusted to the local network conditions in the superuser / service user view in the network configuration section (Figure 19). To save the settings in the network configuration files and to use the new settings, the network must be restarted. The restart can be initiated by clicking on the "Restart network" button.

Before switching on the AFD (ftp) mode, the AFD configuration file should be carefully installed, see 8.8 AFD mode for further information.

Figure 20 shows the contents of the "Config System" tab, which allows access to parts of the system:

Parameter	current Value	new Value	
Location	DachBerlin	<input type="text"/>	set
Institution	Lufft	<input type="text"/>	set
WMOSStationCode	0	<input type="text"/>	set
WIGOSStationID		<input type="text"/>	set
Comment		<input type="text"/>	set
Longitude	0	<input type="text"/>	set
Latitude	0	<input type="text"/>	set
Zenith	0	<input type="text"/>	set
Azimuth	0	<input type="text"/>	set
Altitude	0	<input type="text"/>	set
UseAltitude	0	<input type="text"/>	set
LoggingTime	15	<input type="text"/>	set
Unit	0	<input type="text"/>	set
Layer	3	<input type="text"/>	set
TimeZoneOffsetHours	0	<input type="text"/>	set
BlowerMode	0	<input type="text"/>	set
RangeResolution	3	<input type="text"/>	set
RangeStart	5	<input type="text"/>	set
RangeEnd	10000	<input type="text"/>	set
RangeHrDim	32	<input type="text"/>	set
NetcdfMode	1	<input type="text"/>	set
UAPD	210000	<input type="text"/>	set
ApdControlMode	2	<input type="text"/>	set
Standby	0	<input type="text"/>	set
CloudDetectionMode	3	<input type="text"/>	set
TestMode	0	<input type="text"/>	set
BackscatterMax	40000000	<input type="text"/>	set

Figure 20 Web interface: Config System upper part (superuser).

Filling out Location, institution, longitude and latitude is always very helpful if data are investigated and compared with other instruments and if the Lufft support is required to identify any issues.

For safety reasons, some parameters are not listed in the superuser mode. Further down on the same page, firmware updates can be uploaded to the instrument in superuser mode (Figure 21). New firmware files are packed as back-up zip files and must be uploaded in this form. New firmware versions are published on the Lufft website. A list of previously released versions is attached to this manual in section 11.2.



Figure 21 Web interface: Config system bottom section (superuser).

Figure 22 shows the page “Config RS485”. In case a modified telegram format description file will be uploaded (telegramformat.xml) some important notes must be considered:

- Any firmware update will overwrite the existing telegramformat.xml.
- It is necessary to restart the firmware once the modified file has been uploaded.



Modified telegram description file

Before updating the firmware, users must save their modified description file locally. The individual „telegramformat.xml“ file must be uploaded after the firmware update. The new description file will only take effect after a restart of the ceilometer.

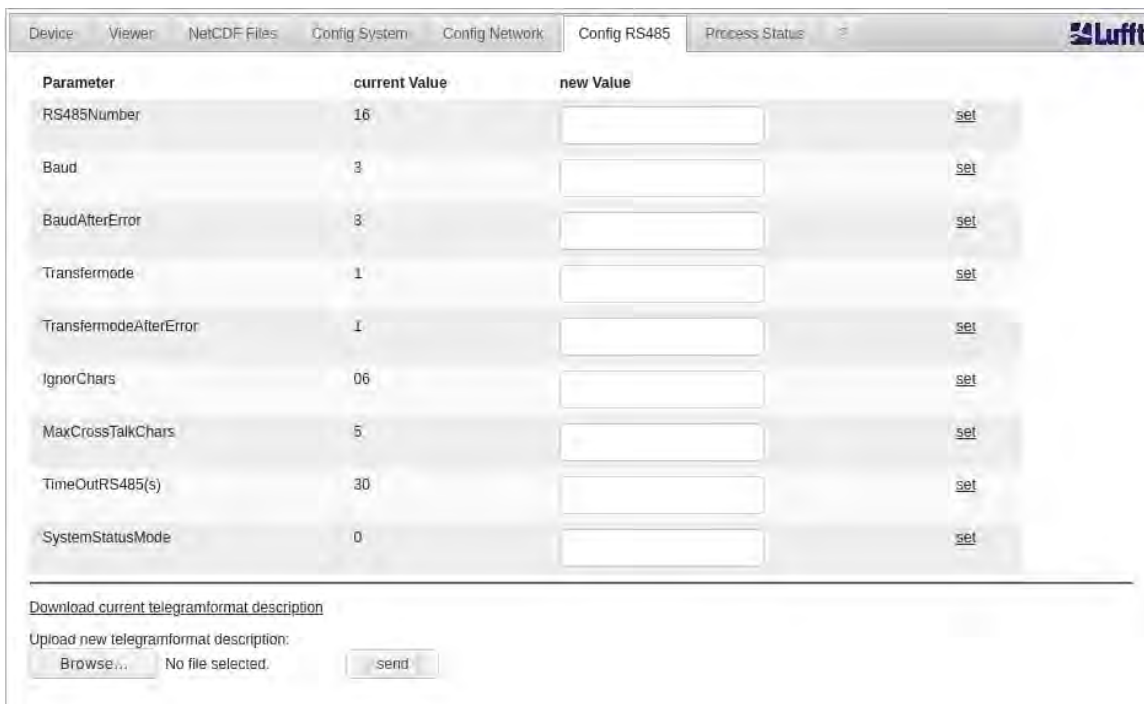

Figure 22 Web interface: RS485 configuration (superuser).

8.7.4 Status and error messages (process status)

The upper part of the “Process Status” tab of Figure 23 is mainly used by Lufft service personnel to identify problems and faults. In the lower parts of the tab NTP- and AFD-service information might be displayed, if applicable.

The NTP status can be used to check if the NTP daemon for automatic time synchronization (see section 8.7.5) is working. The information about the NTP service is only displayed and updated every minute if the NtpMode is active (equal to 1). The display of the NTP status (see Figure 23) shows the information requested with the ntpq -pn command. The most important values are only briefly described here. Everything else can be found in the ntpq documentation, for example <http://doc.ntp.org/4.1.0/ntpq.htm>.

Designation	Description
NTP server	Specifies the address of the time server and its selection status. For example, a '*' means that the time server is used for system synchronization.
Reachability of the server	Provides information about the availability of the server during the last connection requests. The accessibility is binary and not octal as specified by ntpq. Each 1 stands for a successful connection and 0 for an unsuccessful connection.
Polling interval [s]	Specifies the interval at which the time server is queried.
Last response [s]	Specifies how many seconds ago the time server was last queried.
Status error	Contains an error code that indicates problems during NTP status generation. For example, the NTP daemon is not active or was started without an Ethernet connection. Normally a 0 is returned.

Table 19 NTP status.

If the AFD mode (advanced file distribution) is activated, the status of the transferred files is displayed. The correct setup or errors encountered during configuration with the AFD configuration file can be detected too.

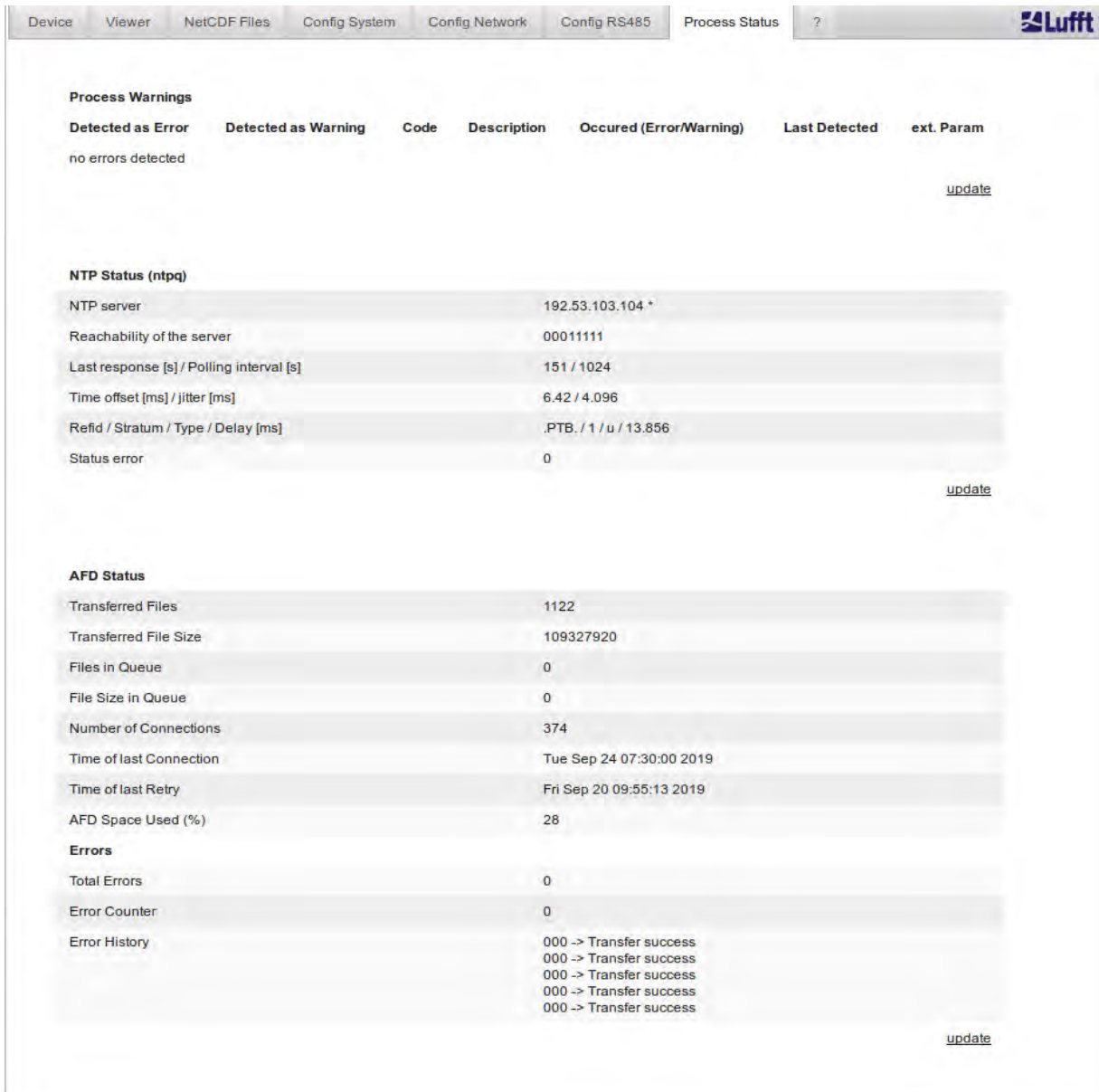

Figure 23 Web interface: Process warnings and error log. AFD and NTP status are only visible if AFD, NTP mode are set to 1.

8.7.5 Time server

Automatic time synchronization with a time server (NTP server) is only performed if the NtpMode parameter is set to 1 and a valid time server (Ntp server) is set. The preconfigured server is: 0.0.0.0 (no time server) and the time server mode NTP mode is switched off.

Using IP addresses is recommended, otherwise a valid DNS server address must be specified before the server address can be used.

Example of the IP address of the time server ptbtime1ptb.de: 192.53.103.108

If the NtpMode is activated during operation and the time difference between server and CHM 8k is greater than 1000 s, no time synchronization is performed. In this case, a firmware restart or one-time manual time setting with reactivation of the NtpMode is necessary to take over the time of the time server. Status information can be queried in the web interface in the "Process Status" tab.



Please note:

The user should avoid automatic time settings via the date-time command (RS485) with simultaneous execution of ntpd over TCP / IP.

8.8 AFD mode

A specific communication mode called automatic file distribution (AFD) mode is supported by the CHM ceilometer series. AFD is used by the CHMs to automatically send data measured in NetCDF format to an ftp server. The operation requires an active Ethernet connection.

The AFD mode can be activated via the web interface (Figure 19) in superuser mode. The configuration file "afdsettings" must be downloaded, configured, and uploaded again to accommodate local requirements.

AFD is preset to transfer three 5-minute NetCDF files every 15 minutes. The user can merge the NetCDF files into 24-hour files.

The configuration file "afdsettings.txt" is shown below. The official file name is: "DIR_CONFIG". Further information on the commands listed here can be found on the [DWD-AFD website](#). Hashes (#) are used to comment out commands.

Configuration file "afdsettings.txt"

```
[directory]
/tmp/afd/netcdf/afd-src

[dir options]
delete unknown files 0
delete queued files 6

[files]
*

[destination]

[recipient]
ftp://user:password@host_ip/path/%h/%tY/%tm

[options]
priority 9
create target dir
time */15 * * * *
lock DOT
age-limit 3600
# exec -d bzip2 %s
```



When editing the configuration file:

The full format (blank lines and indentation depth) of the afdsettings file is important. If the sample file is downloaded from the ceilometer, carefully replace each item step by step. "#" is used to leave a comment instead of a statement.

Example for a "afdsetting.txt" file:

```
Ftp server 192.168.1.51
Subdirectory from root on server: /home/chm_data
User name: afd
Password: eXample
```

```
[recipient]
ftp://afd:eXample@192.168.1.51//home/chm_data/%h/%tY/%tm

[options]
priority 9
create target dir
time */15 * * * *
lock DOT
age-limit 3600
exec -d bzip2 %s
```

Every 15 minutes, bzip-compressed files are transferred to the ftp server in a directory specified by /home/chm_data/hostname/year/month. Hostname “%h” is the device name, e.g. CHM198001, year “%tY” and month “%tm” are the time settings specified by the device.

A double-slash // after the IP address indicates that the path starts in the source directory; a single slash / indicates that the path starts from the ftp-home directory.

An ftp path in the Windows directory may look like this:

```
ftp://afd:eXample@162.168.1.51/%h/%tY/%tm.
```

The file is stored in the subdirectory /%h/%tY/%tm of the main directory on the ftp server.

The command “time * * * * *” sends a 5-minute NetCDF file immediately after it is created

8.9 Telegram via Ethernet

In addition to the RS485 interface, it is also possible to receive data telegrams via the Ethernet interface. There are two different transmission modes. The telegrams can be interrogated individually (polling mode) or sent automatically by the Ceilometer.

For the configuration of the behavior of the telegram output via Ethernet the parameter „LanPort“, „LanTelegramNumber“ and „LanTransferMode“ are available. These parameters can be set via RS485 or in the register “Config Network” of the web interface, refer to Table 4.

All user data telegrams described in section 8.3 Data query RS485 can be requested. The raw data telegram is still uuencoded as in RS485 transmission mode and must be uudecoded before it can be read.

The Ceilometer (server) waits on the port "LanPort" until an external (client) connection request is received. Only then it can send telegrams to the client. Such a request can be executed for example with ncat or telnet. A request of a client to a CHM with the IP 192.168.100.101 and a LanPort of 11000 can look like this:

```
ncat 192.168.100.101 11000
or
telnet 192.168.100.101 11000
```

On Windows operating systems, binary net tool files can be downloaded and installed from the server <https://nmap.org/download.html>. This website also provides binary and source codes for other operating systems.

After a connection request from the client, in the **polling mode** just a single telegram (in the “LanTelegramNumber” specified format) will be sent and then the connection from the CHM will be stopped.

In the automatic transfer mode, the CHM is sending continuously (in the logging interval) telegrams to all connected clients.

8.10 NetCDF file tools

Several tools are available for processing, modifying, or merging NetCDF files. In particular, when used in AFD mode, the nrcat.exe program is very powerful for merging files, in order to create 24-hour files from individual 5-minute files.

The same command can also be used to merge individual NetCDF files from raw data telegrams into day files.

nrcat is part of the nco tool set and can be downloaded from the following website:

<http://nco.sourceforge.net>

For users of the Windows operating system:

The direct application of the command nrcat.exe in the Windows command line is restricted by the use of wildcards and the total length of the command line. We recommend using git-bash, for example, to circumvent this problem.

Example:

The following command line allows the merging of all NetCDF files that are located in the data directory of device CHM123456 for April 6, 2015. The output file of the example is out.nc.

```
nrcat.exe -Y nrcat -h data/20150406_Berlin_CHM123456*.nc out.nc
```

9 Data Evaluation / Sky Condition Algorithm (SCA)

The CHM 8k ceilometer is a laser remote sensing device with embedded algorithm for determining layers of particles and droplets in the atmosphere. The embedded algorithm is collectively referred to as the Sky Condition Algorithm (SCA). Ceilometers determine the cloud base and provide information on the penetration depth into cloud. In case another cloud or aerosol layer can be measured above the lower cloud the penetration depth can be interpreted as cloud thickness. In addition, the degree of cloud coverage is determined in terms of eighths of the sky. For visibilities below 2 km the vertical visibility (VOR) is calculated and output in addition. An aerosol algorithm based on a wavelet algorithm detects different aerosol layers and transmits those detected within the atmospheric boundary layer. Fog / haze and precipitation are detected and transmitted in the Sky Condition Index (SCI) parameter.

9.1 Laser remote sensing

A pulsed near infrared laser probes the sky vertically from the top of the instrument up to 10 km altitude. Targets like aerosol layers and clouds show up as echoes with certain backscatter intensity and signal extinction. Rayleigh scattering by air molecules is negligible at a laser wavelength of 905 nm. The distance of the scattering particles to the instrument is calculated from the travelling time of the laser pulses.

9.2 Preparation of the measured data

Data pre-processing is an important task before the different steps in the SCA algorithm begin. The main reason for this is to harmonize / normalize the data sets between different CHM 8k systems to get similar results, e.g. for cloud bases, even if the sensitivity between instruments varies.

Each single measurement is normalized with the output power I of the laser, which is measured with the aid of photodiodes. Also, the detection sensitivity is considered by measuring a reference light pulse on the detector and using the signal strength p_{cal} for normalization. Brightness fluctuations of the reference light pulse are corrected by an additional photodiode measurement p_{ref} . Differences between different CHM 8k instruments are compensated by a scaling factor c_s , which is determined using a comparison measurement with a reference device. Figure 24 shows the profiles of two different devices after normalization and calibration. A cloud is visible in the signal at a height of approximately 2.5 km.

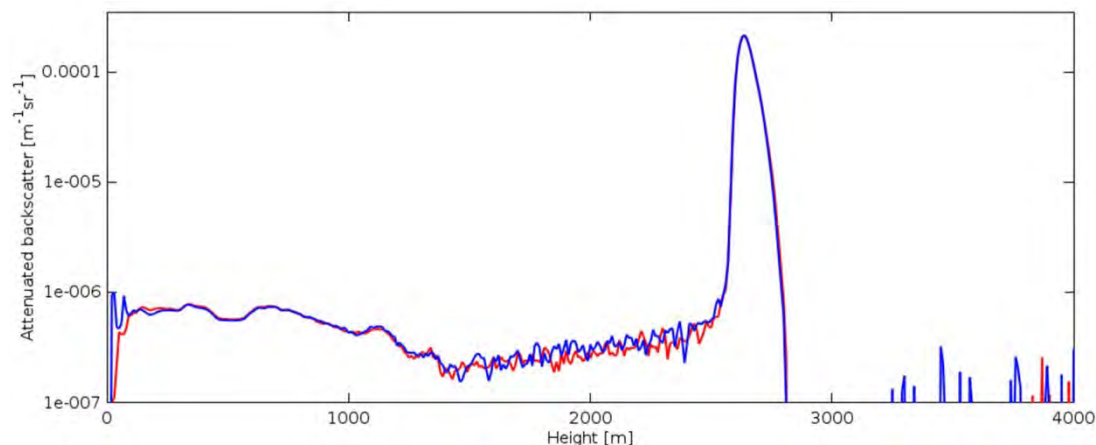

Figure 24 Normalized and calibrated backscatter signals of two different CHM 8k instruments.

The following formula is used to obtain the normalized backscatter intensity:

$$P(r) = \frac{P_{raw}(r) - b}{c_s \cdot O(r) \cdot I} \cdot \frac{p_{ref}}{p_{cal}}$$

Here, P_{raw} corresponds to the raw backscatter signal, b to the baseline and $O(r)$ is the overlap function. The backscatter values in the NetCDF files are stated as attenuated backscatter

$$\beta_{att} = P(r) \cdot r^2 \cdot c_{cal}$$

in $m^{-1} \cdot sr^{-1}$. The attenuated backscatter is calculated from the normalized signal $P(r)$ through multiplication by r^2 and a calibration constant c_{cal} .

A further processing step is performed to determine cloud heights and aerosol layers. To compensate for the reducing signal-to-noise ratio at higher altitudes, the signal is averaged with a height-dependent averaging time as shown in Figure 25. At different altitudes, the time averaging varies from 15 seconds below 3 km to 300 seconds above 6 km.

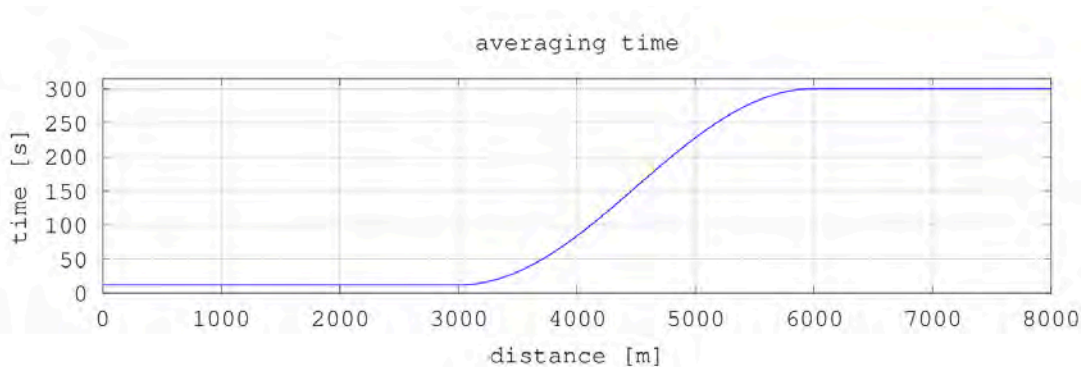

Figure 25 Example of time averaging for determining cloud heights.

9.3 Cloud ceilings / cloud base heights

After successful preprocessing, the averaged backscatter profile is used to identify cloud echoes, rain, fog and aerosol layers and to distinguish between these events. Figure 26 shows a day intensity plot where all significant backscatter signals are coded in black.

The SCA algorithm now identifies precipitation events and aerosol structures and then calculates the cloud heights and penetration depths.

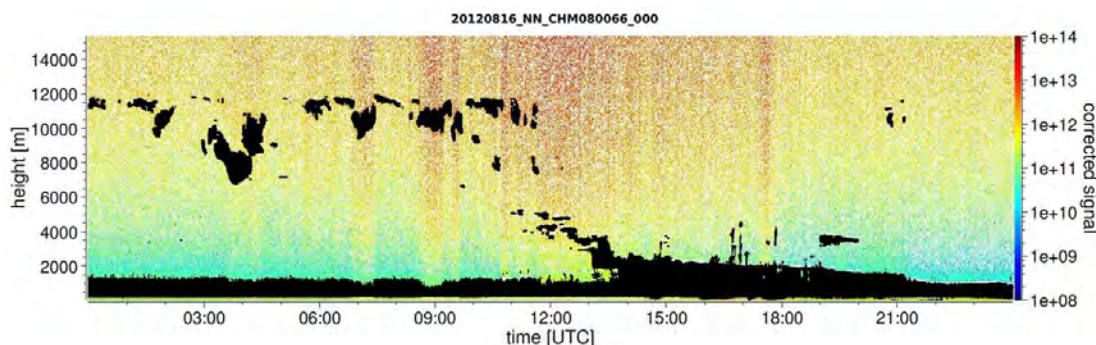

Figure 26 Cloud detection algorithm.

9.4 Cloud penetration depths

Cloud penetration depth is determined by detecting a cloud base and then an upper cloud height using the signal intensity level that was determined for the cloud base. Subtracting these values gives the cloud penetration depth.

A threshold and gradient method is used to check the region of the identified values, in order to determine penetration depth uncertainty. Figure 27 shows how the cloud parameter evaluation process is performed.

It should be noted that the above-mentioned upper cloud height is generally not the highest point of the cloud. The penetration depth and the cloud cover are similar only if the ceilometer detects another cloud layer with a firm target above it. In most cases, the laser light in the cloud is scattered and highly attenuated and the cloud cover can no longer be identified above the cloud.

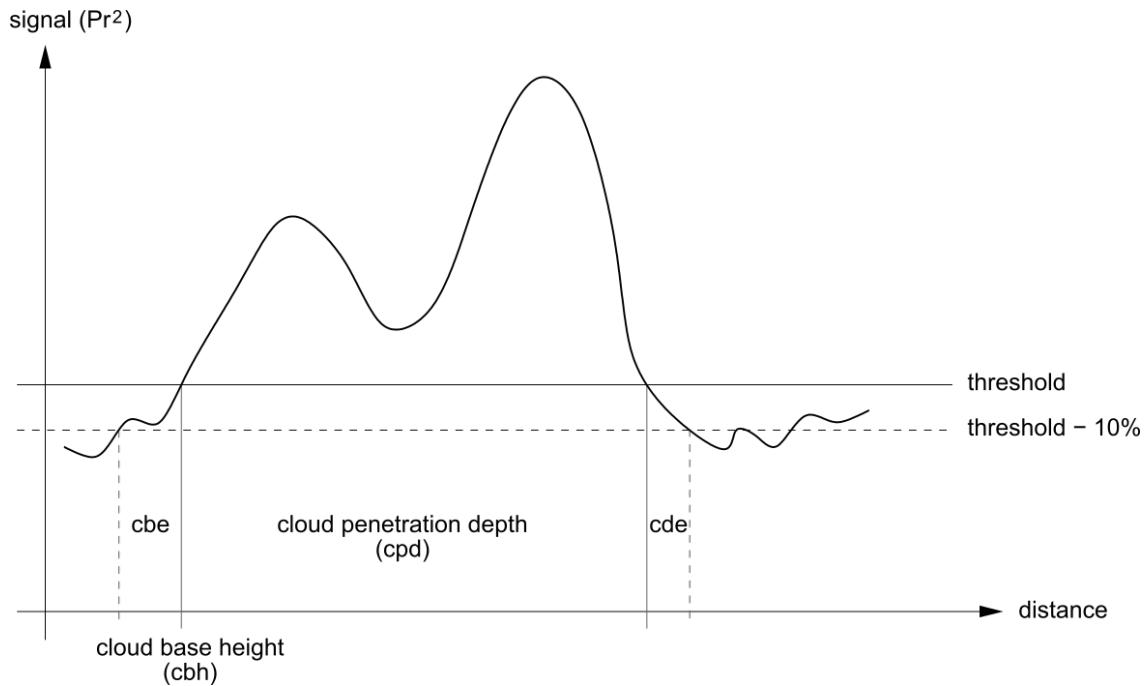

Figure 27 Evaluation process for different cloud parameters.

9.5 Parameters for data evaluation

A set of parameters control the data evaluation routine. System dependent data are stored on the laser optical module (LOM). Data accessible to users are listed in Table 4 and Table 5.

If the instrument is tilted to the zenith and the zenith angle is entered correctly, the cloud distance and other ranges are corrected by this angle.

9.6 Determination of the maximum detection range (MXD)

The maximum detection range corresponds to the maximum distance from which significant signals are still being measured. It results from the signal / noise ratio (S/N) as a function of the distance. At altitudes outside the boundary layer, only clouds or denser aerosol layers generate significant signals. The maximum detection range is calculated independently of the cloud detection algorithm and can be used to check the result, e.g. if the ceilometer can detect neither a cloud layer nor a vertical optical range. Here, the MXD can be used to check whether the result "Clear sky" is correct.

9.7 Vertical optical visibility (VOR)

The method for determining the vertical visibility (VOR: Vertical Optical Range) is described in ISO standard 28902-1:2012. The step by step approach how the VOR is determined by the device is described below:

First, all sections in the backscatter signal (9.2 Preparation of the measured data) with a signal-to-noise ratio > 5 are identified. For these relevant intervals, the Klett inversion method is used to determine the extinction $\alpha(r)$.

The vertical optical visibility is the distance, where the integral of the extinction is equal to 3.

$$\int_0^{VOR} \alpha(r) dr = 3$$

The range for calculating VOR is limited to an altitude of 3 km. The data output depends on the selected data telegram. In the standard telegrams 1 - 3, the vertical visibility is always transmitted, while in the user telegrams 8 and 9, which correspond to the CT25k data telegram, VOR or the lower cloud limit is transmitted.

9.8 Precipitation and fog

Fog and various types of precipitation are detected by multiple scattering. Typically, only single scattering processes are considered as the signal source. Strong atmospheric haze and high particle density correspondingly generate a stronger signal than usual close to the device. An integral over the signal in certain ranges is used to evaluate haze and precipitation.

9.9 Mixing layer height

Aerosols which are detected near the ground spread in the lower air layer, where the upper limit can be defined as a planetary boundary layer (onshore) and maritime boundary layer (offshore). The lowest aerosol layer that can be identified within the boundary layer can be interpreted as mixing layer height (MXL). The MXL like all aerosol layer structures in the boundary layer depends on atmospheric conditions and on sunny days mostly on daytime.

Aerosol layer heights can be identified by analyzing gradient signatures in the backscatter signal. The quality of the detected aerosol layers depends very much on the local conditions and time. Table 20 shows an index describing the quality of the identified aerosol layers in terms of high accuracy and low uncertainty.

Q-Index	Description
/ (telegram) -1 (NetCDF)	There is insufficient raw data for a calculation
- (telegram) -2 (NetCDF)	Hardware error or system is not ready to measure
(telegram) -3 (NetCDF)	Algorithm cannot detect values
0	No particle layer detected (index was not calculated in older firmware versions)
1	Particle layer detected with high accuracy (< 50 m)
9	Particle layer detected, but with low accuracy

Table 20 Q-Index description of aerosol layer height.

9.10 Cloud cover (BCC / TCC)

The cloud coverage is determined statistically from the behavior of the lower cloud bases over time. Here, a distinction is made between the coverage of the lowest cloud layer (BCC: base cloud cover) and the total of all cloud layers (TCC: total cloud cover). The values for these parameters are also stored in the NetCDF files.

The time interval considered is height-dependent (Figure 28). The frequency of the occurring cloud layers is determined for each height interval. This histogram is smoothed with a height-dependent weighting function. Within this smoothed frequency distribution, the peaks are separated. All cloud bases within a peak are bundled into a cloud layer.

Sections that contain cloud bases are counted against the total number of cone sections. The cloud cover values are expressed as a percentage from this comparison. The final degree of coverage is reported in eighths Table 21 lists the WMO code 2700 for the cloud cover index.

Eighth	Description
- (telegram) -2 (NetCDF)	System hardware error or system not yet ready for operation
/ (telegram) -1 (NetCDF) -3 (NetCDF)	Cloud bases could not be determined due to fog or other non-meteorological reasons, or no observation was made
0	Clear sky
1	1 okta: 1/10 – 2/10
2	2 okta: 2/10 – 3/10
3	3 okta: 4/10
4	4 okta: 5/10

5	5 okta: 6/10
6	6 okta: 7/10 – 8/10
7	7 okta or more, but <10/10
8	8 okta: 10/10
9	Sky obscured by fog or other meteorological phenomena

Table 21 Degree of coverage, WMO code 2700 and definitions in 10th.

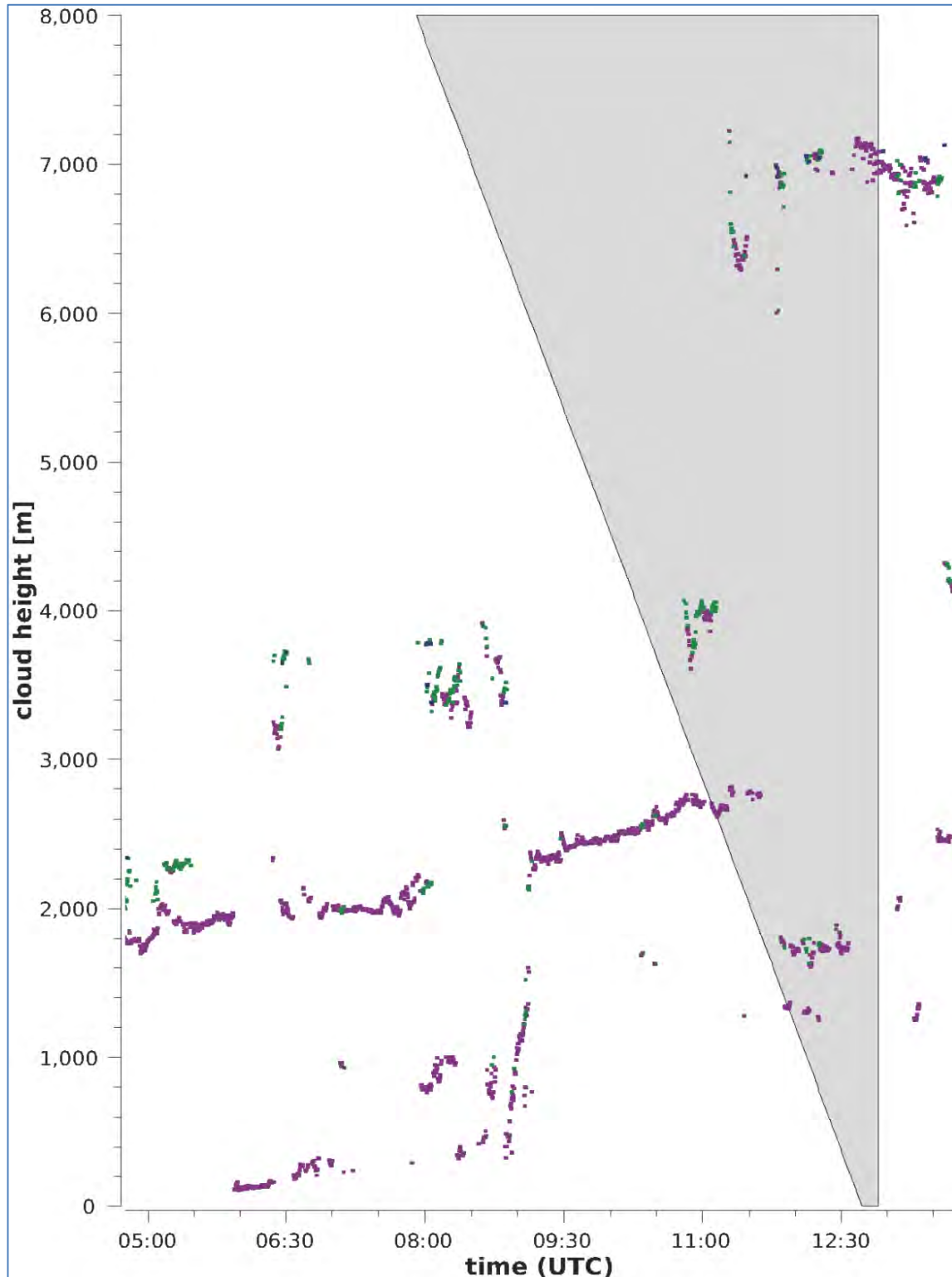

Figure 28 Degree of coverage algorithm.

Note: The selected time interval for calculating the cloud cover depends on the area in which a truncated cone function is used for the calculation.

9.11 Sky Condition Index (SCI)

To better understand certain events, the Sky Condition Index is written to the extended data telegram and NetCDF files. In older CHM systems, the variable was treated as a precipitation index.

Table 22 shows how the index is defined.

Value	Description
-- -2 (NetCDF)	System hardware error or system not yet ready for operation (-2 in NetCDF)
00	Neither fog nor precipitation detected
01	Rain
02	Fog
03	Snow or freezing rain
04	Reduced window transmission, drops on the windows
// (telegram) -1 (NetCDF) -3 (NetCDF)	No observation is made, in the NetCDF the numerical values -1, -3 are used instead of // as in the telegram

Table 22 Sky Condition Index (SCI).

10 Cleaning, Maintenance and Service Instructions

⚠ CAUTION	
	<p>After switching on the power supply, the CHM 8k emits Class 1M invisible laser radiation through the opening at the top of the sensor. When viewed with optical instruments, Class 1M radiation can lead to serious eye injuries.</p> <ul style="list-style-type: none"> ⇒ Never view the laser beam with optical instruments, especially binoculars ⇒ Avoid looking directly into the laser beam

In normal operation, the correct operation of the device can be checked with two LEDs (see Figure 29). A red LED in the lower right corner of the windows is an indicator of device failure. The light turns on in case of a hardware or software fault identified by the main controller. Detailed information about the transmitted error are explained in section 8.5 "Status code". The status code is displayed in the web interface status code (see Figure 15) and output in the RS485 data telegrams and in the NetCDF files. A green LED in the lower left corner of the windows indicates the mains voltage is switched on. When the device is turned on, this LED must be lit. If this is not the case, this indicates an unconnected cable, a switched-off circuit breaker or defective fuses.

10.1 Cleaning

The cover windows of the CHM 8k internal housing are tested for an impact energy of 1 Joule (IEC/EN 61010-1: IK06).

⚠ WARNING	
	<p>Operating the sensor with a broken cover window may result in electric shock, which can cause serious or fatal injury. The shards of the glass can lead to cutting injuries.</p> <ul style="list-style-type: none"> ⇒ Disconnect the ceilometer via the external mains disconnect switch immediately when discovering that a cover window is damaged and secure against reconnection. ⇒ Use protection gloves when handling the broken glass. ⇒ Return the sensor to OTT HydroMet Fellbach GmbH for repair.

NOTICE	
<p>The device may be damaged when maintained insufficiently / inappropriately.</p> <ul style="list-style-type: none"> ⇒ The CHM 8k requires regular cleaning to maintain performance status. ⇒ The CHM 8k requires regular maintenance. This must be performed by service personnel of OTT HydroMet Fellbach GmbH or specially trained technicians only. ⇒ For detailed maintenance instructions, please consult the service manual. 	

Interval	Cleaning	Comment / remedy
Quarterly ¹	Clean the windows (Figure 29): first of all, with plenty of water and a little mild soap. Carefully spread some soap on the windows with your hands and rinse with water. Finally, rinse with distilled water.	Dishwashing liquid, water, hands Do not use microfiber cloths to clean the windows!
As required	Remove deposits in the space below the housing cover	Neutral cleaning agents; microfiber cloths
As required	Remove fouling in front of the entrance grilles of the fans (rear side)	Keep fan intake area clear, see Figure 30
As required	Remove snow ²	Keep fan intake area clear, see Figure 30

Table 23 Cleaning intervals / measures.

¹ with an average dust load of 25 – 35 µg/m³ in the air.

² if snow gets into the air intake of the fans.



Figure 29 Windows to be cleaned.

The red "Error LED" is in the lower right corner of the receiving window.

1: Laser output on the left side, with green indicator light in the lower left corner

2: Receiver input on the right side, with red LED



Figure 30 Fan.

The area below the fans must be kept free of snow and debris.

10.2 Maintenance intervals and measures

⚠ WARNING	
	<p>Live parts may be accessible inside the inner sensor housing if a fault occurs. Touching live parts may result in electric shock, which can cause serious or fatal injury.</p> <ul style="list-style-type: none"> ⇒ Do not open the inner sensor housing door. Maintenance work may only be carried out by trained service personnel. All maintenance work requires a technical qualification in electrical safety. ⇒ Switch off the external circuit breaker before carrying out any maintenance and repair work and secure against reconnection.

Table 24 lists the recommended preventive maintenance measures and the interval for regular checks. The inner sensor housing door must be opened to carry out the maintenance measure and the work therefore must be carried out by the service staff of OTT HydroMet Fellbach GmbH or by the customer's authorized and trained personnel.

Further detailed information beyond the scope of this manual (maintenance, replacement, details of units) can be found in the service manual. This is only available to employees of OTT HydroMet Fellbach GmbH or specially trained personnel who possess a written certificate of competence (valid certificate) for the corresponding maintenance and service work.

If you have any questions or a procedure mentioned in this operating manual does not help to remedy an existing problem, we recommend contacting the service technician on site or OTT HydroMet Fellbach GmbH.

Interval	Preventive maintenance measures	Comment
REGULAR CHECKS	Check the dehumidifier bag CONTAINER DRI II (desiccant) for integrity and replace if necessary	By service staff only
At least once a year	Change the dehumidifier bag CONTAINER DRI II	By service staff only
Approx. every 3 – 5 years	Replace SD card	By service staff only
Approx. every 5 years	As a preventive measure: Replace the rubber seal of the inner door (in case of material fatigue)	By service staff only
Approx. every 5 years	As a preventive measure: Replace the lightning protection elements (also after lightning strike)	By service staff only

Table 24 Preventive maintenance intervals and measures.

11 Appendix

11.1 CHM 8k device hardware version

Revision	Date of change	Changes	Comment
REV V1	01.03.2018		First series version
REV V2	01.08.2018	Update internal wiring, Update PCBs	
REV V3	01.08.2019	Update Mainboard	
REV V4	15.12.2019	Update Lasermonitor	
REV V5	11.05.2020	Control of fan transformer	
REV V6	12.05.2020	Update Mainboard	
REV V7	01.11.2020	Update for US-variation	
REV V8	07.05.2021	Update Mainboard	component replacement
REV V9	10.09.2021	Update Mainboard	component replacement
REV V10	08.02.2022	New detector unit	component replacement

Table 25 Hardware revisions (HardwareVersion 0 means value not set)

11.2 CHM 8k firmware version

The first firmware is based on version 0.748 for the CHM 15k Nimbus.

The operating system version: 18.04.1, based on version 17.05.1 for the CHM 15k Nimbus.

The FPGA versions listed in Table 26 are only valid from device hardware REV V2.

OS / FPGA version	Description	Released
FPGA 4.17 (11.09.18)	1. New: Module for laser status and watchdog	Sep 2018
FPGA 4.18 (10.01.19)	1. New: Module for laser status and laser reset	Mar 2019
FPGA 4.20 (31.10.19)	1. New: Module for laser status and laser reset 2. New: Module for mainboard cooler	Sep 2019
FPGA 4.22 (22.09.2020)	1. Module relay control in case of CPU error	Sep 2020
OS: 18.10.1	Just relevant for production 1. Correction of the script name for initializing the EEPROM	Oct 2018

Table 26 Operating system / FPGA releases

Firmware versions also suitable for devices with FPGA version \leq 4.17:

Firmware version	Description	Released
0.753	<ol style="list-style-type: none"> 1. New NetCDF format with new variables <ul style="list-style-type: none"> - beta_att Attenuated backscatter (replaces beta_raw) - temp_las Laser temperature - laser_power Laser power - voltage_las Laser voltage - voltage_det Detector voltage - voltage_led LED voltage - voltage_dc DC voltage - background_det Background light detector - p_ref PIN diode signal - c_cal Calibration constant - p_window Window sensor signal - humidity Humidity in housing - fan Fan activity 2. Laser power monitoring with switch-off mechanism 3. New passwords for web access 4. Reorganization of the setup concept 5. Reassignment of status codes 6. Separate laser operating time in EEPROM 7. New Linux operating system (OS 18.04.1) 	May 2018
1.000	<p>Requires FPGA-Version 4.17 and hardware version REV V02</p> <ol style="list-style-type: none"> 1. Universal RS485 address 99 introduced 2. Escalated status codes in telegrams 1 and 5 3. Output of status information after device restart 4. Seven additional comment memories for customer use Output in telegram 4 (Note: variable length) 5. Visibility determination based on data from current logging interval 6. Time averaging for the cloud detection algorithm from above 3,050 m only 7. MIME type for downloading various settings files (chm*, afd*, telegram) corrected 8. Calibration constant set to 3.2e-12 (Note: The measurement data beta_att in NetCDF is approx. 4.44 times greater than in version 0.753) 9. ApdControlMode 2 introduced (automatic selection of a detector voltage dependent on the detector breakdown with temperature tracking.) 10. Extension of the automatic function control (cable tests, settings) 11. LaserFrequencyMode for changing the laser frequency rate introduced; the LaserFrequencyMode (LFM) can be set in ServiceMode via RS485 and the web interface. 	Sep 2018
1.010	<ol style="list-style-type: none"> 1. Firmware also runs with older hardware / FPGA (version-dependent handling of laser status messages) 	Nov. 2018

Table 27 Firmware versions also suitable for devices with FPGA version ≤ 4.17 .

Firmware versions only suitable for devices with FPGA version ≥ 4.18 :

1.020	<ol style="list-style-type: none"> 1. Transmission of the automatic telegram via LAN is possible (LanTransferMode == 1 (auto)) 2. Renaming the setting LanTelegramMode to LanTelegramNumber (LTN) 3. Introducing the button SystemStatusMode (SSM) for the used status code type in the telegrams (0 = normal; 1 = escalating) (default value 1) 4. Writing of additional information in chmsettings.txt (MAC address, serial number CPU, overlap information, mainboard- and CPU version) when downloading 5. "Process Warning" tab renamed to "Process Status" 6. Display of NTP status in "Process Status" tab if NtpMode is 1; accessibility of NTP server (part of NTP status) can be queried via RS485 (NtpStatus (NST)) 7. CloudDetectionMode bit 1 for cloud and MXD detection on base line compensated signal 8. Window reflex correction is performed on raw data; new NetCDF variable 'win_param' for the scaling factor of the window correction 9. Change in NetCDF: adapting the scale_factor for the variable voltage_det (0.01->0.1, Avoid overflow with voltages greater than 327.67 V) 10. No data processing delay during download of several NetCDF files via the web interface 11. Web: New logo; CHM serial number and favicon in browser tab 12. Scaling corrected for the web viewer tab 13. Mainboard fan can be switched on over RS485 temporarily (ToggleMainboardFan (TMF)); status is reported in NetCDF and telegram 14. Minimal value of RangeDimHr set to 10 	Sep 2019
1.030 1.040	<ol style="list-style-type: none"> 1. Remove NetCDF files at the end of a month only if zip file was created successfully 2. Bugfix (NetCDF creation) 	Nov. 2019 Jan. 2020
1.050	<ol style="list-style-type: none"> 1. Additional telegrams (6 and 7) predefined, see section 8.3.6 2. Extended outputs in the device tab of the web interface and reduction of the update time interval 3. WIGOS Station Identifier introduced 4. Status code revised (NTP status and humidity warnings introduced), see section 8.5 5. Parameter NetcdfMode introduced, see Table 14 6. Improved aerosol layer detection and quality index pbs 7. Correction of the calculation of optical state (state_optics) and thus the occurrence of the window contamination warning 8. Firmware adapted for compatibility with new CHM cloud simulator 9. Feedback behaviour for firmware updates via web interface revised 10. Adjustable laser frequencies changed, see section 8.1 11. Bug fixes 	Sep. 2020
1.060	<ol style="list-style-type: none"> 1. Adjustments in the cloud detection algorithm in "CHMTest" mode due to hardware changes in the CHM cloud simulator. 2. Limits for temperature errors were adjusted to specified temperature range, internal temperature up to 65°C and outdoor temperature up to 60°C. 	Oct. 2020

1.070	<ol style="list-style-type: none"> 1. Re-sorting of the status codes. "Note: NTP problem" set to bit 12, see section 8.5. 2. Changes in telegrams 1 to 5: output of cloud height offset instead of altitude, see section 8.3.3ff 3. Changes in telegrams 1 to 3: output cloud height offset for non-negative values without "+". This allows to output a maximum value of 9999 instead of only +999 (meters or feet, depending on the setting). 4. Output of the messages of the escalating status code from 0x8000 0000 onwards in the telegrams corrected. 	Nov. 2020
1.080	<ol style="list-style-type: none"> 1. Bugfix: Number of digits of cloud height offset in telegram 1 and 5 fixed to 4 again. 	Dec. 2020
1.090	<ol style="list-style-type: none"> 1. Telegram change as the status was undefined before: As overflow value the character '?' will be used. Except when a valid overflow value is defined in telegramformat.xml, details also in the document "XML-CHM-telegram-format.pdf". Preset are: <ul style="list-style-type: none"> • Telegram 1 and 5: Overflow "9999" for penetration depth (CPD) • Telegram 2 and 4: Overflow "9999" for standard deviation of the penetration depth (CDE) 2. Upload of the telegram format xml file now possible as "SuperUser" via web front end. 3. Character length for parameter (Location, Institution,...) will be cut to max field length, see Table 5. 	March 2021
1.100	<ol style="list-style-type: none"> 1. Identification of new hardware release of CHM8k Mainboard (rev 7) 2. Correction of the check sum of "CL31- telegrams" 	May 2021
1.110	<ol style="list-style-type: none"> 1. Shutdown time of the firmware reduced to 4s 2. Support for different detector modules "APDControlMode" 1 and 2. 3. Downgrade option of firmware removed 4. NTP failure state (Bit 12) is no longer displayed on the red housing (failure) LED 5. Bug-fixes: <ol style="list-style-type: none"> a. CHMTestMode can be switched off via web frontend even if it was started from RS485 b. Parameter "rangeEnd" works for selected ranges <6000m 	March 2022

Table 28 Firmware versions only suitable for devices with FPGA version ≥ 4.18.

a passion for precision · passion pour la précision · pasión por la precisión · passione per la precisione · a pa



OTT HydroMet Fellbach GmbH
Gutenbergstraße 20
70736 Fellbach

Phone: +49 711 518 22 – 0
met-info@otthydromet.com
www.lufft.com