

User Manual

Lufft CHM 15k Ceilometer

passion for precision · passion pour la précision · pasión por la precisión · passione per la precisione · a passion for



www.lufft.com



Contents

1	General Information	4
2	Safety	5
2.1	Standards and Directives	5
2.2	Safety instructions for the laser system	5
2.3	Requirements for the personnel	5
2.4	Safety instructions for transport, installation, commissioning and cleaning	5
2.5	Description of the notes and symbols	6
2.5.1	Description of warning symbols	6
2.5.2	Description of precautionary statements	6
2.5.3	Symbols used	7
2.6	Product labeling CHM 15k	7
2.7	Designated use	8
3	Technical Data	9
3.1	Ordering information	9
3.2	Technical data	9
4	Technical Description	12
4.1	Construction of the CHM 15k	12
4.2	Functional units of the inner housing	13
4.2.1	Functional diagram	13
4.2.2	Function control and device status	14
5	Transport / Scope of Delivery	15
6	Installation	17
6.1	Installing the CHM 15k	17
6.1.1	Preparatory work	17
6.1.2	Installing on the foundation	18
6.2	Electrical installation	20
7	Commissioning and Decommissioning	24
7.1	Starting up with the RS485 connection	24
7.2	Starting up with the LAN connection	25
7.3	Shutdown	26
7.4	Disposal	26
8	Communication via RS485 & Ethernet	27
8.1	List of configurable parameters	27
8.2	Device configuration with RS485	32
8.2.1	Reading out a parameter	32
8.2.2	Setting a parameter	32
8.2.3	Changing the baud rate	33
8.2.4	Restarting the embedded system / resetting to factory settings	33
8.2.5	Changing time settings	34
8.3	Data query RS485	34
8.3.1	Polling mode	34
8.3.2	Automatic output mode	35
8.3.3	Standard data telegram	35
8.3.4	Extended data telegram	37
8.3.5	Raw data telegram	40
8.3.6	Additional data telegrams	41

8.4	Structure of the NetCDF format	41
8.4.1	General	41
8.4.2	Basic principles	42
8.4.3	File names.....	42
8.4.4	Format structure.....	42
8.4.5	Substitute values for target variables.....	47
8.5	Status code	48
8.5.1	Escalated status codes	49
8.6	Firmware update	52
8.7	Communication via the web interface (Ethernet).....	52
8.7.1	Device overview and access rights (Device tab)	52
8.7.2	Access to measurement data (NetCDF files, viewer).....	53
8.7.3	Configuring the CHM 15k (Config tab).....	54
8.7.4	Status and error messages (process status).....	57
8.7.5	Time server	58
8.8	AFD mode	59
8.9	Telegram via Ethernet.....	61
8.10	NetCDF file tools.....	61
9	Data Evaluation / Sky Condition Algorithm (SCA)	62
9.1	Laser remote sensing.....	62
9.2	Preparation of the measured data	62
9.3	Cloud ceilings / cloud base heights	63
9.4	Cloud penetration depths.....	63
9.5	Parameters for data evaluation.....	64
9.6	Determination of the maximum detection range (MXD).....	64
9.7	Vertical optical visibility (VOR).....	64
9.8	Precipitation and fog	65
9.9	Aerosol and mixing layer height.....	65
9.10	Cloud cover (BCC / TCC)	65
9.11	Sky Condition Index (SCI).....	68
10	Cleaning, Maintenance and Service Instructions	69
10.1	Cleaning.....	69
10.2	Maintenance intervals and measures	71
11	Appendix.....	73
11.1	CHM 15k device hardware version	73
11.2	CHM 15k software version.....	73

1 General Information



This operating manual is part of the equipment. It must always be kept close to the equipment so that it can be accessed quickly when needed.

This operating manual must be read, understood and observed in all respects by all persons responsible for the equipment and all persons who work on it. This concern, in particular, the section "Safety".

Editorial deadline: March 2022

Documentation number: 8350.MEP

This operating manual is valid for the following versions of the equipment:
CHM 15k with the order numbers:

8350.00	8350.10
8350.01	
8350.00-BAT	

Manufacturer

OTT HydroMet Fellbach GmbH
Gutenbergstraße 20
70736 Fellbach, Germany

Telefon +49 711 518 22 – 831

E-Mail met-service@otthydromet.com

Date	Revision	Notes
July 2019	R13	Firmware 1.010, major changes, safety regulations revised
January 2020	R15	Firmware 1.040, revisions
September 2020	R16	Firmware 1.050, revisions
February 2021	R17/R18	Firmware revisions 1.070, 1.080, address change
March 2019	R19	Firmware 1.090/ 1.100/ 1.110 - max length of test parameter listed - RS485 parameter example out of range added - Note using individual telegramformat.xml file - firmware downgrade option no longer available - UPS description and functionality added

Copyright

© 2021

This manual is protected by copyright. No part of this manual may be reproduced in any form (photograph, photocopy, microfilm or any other method) or processed, duplicated or distributed using electronic systems without the written permission of OTT HydroMet Fellbach GmbH. Violations will be prosecuted. The manual was prepared with due care. No liability is assumed for damages resulting from failure to observe the information contained in the manual.

2 Safety

2.1 Standards and Directives

The device is designed according to the recognized rules of technology and safety. The applied rules are listed in the currently valid declaration of conformity. Declarations of conformity can be downloaded from our homepage:

<https://www.lufft.com/products/cloud-height-snow-depth-sensors-288/ceilometer-chm-15k-nimbus-2300/>

2.2 Safety instructions for the laser system

The CHM 15k Ceilometer is classified as a Class 1M laser product according to IEC 60825-1:2014-06. It complies with 21 CFR 1040.10 except for deviations pursuant to Laser Notice No. 50, dated June 24, 2007. The sensor emits a beam of invisible laser radiation (1064 nm) with small divergence (< 0.5 mrad) and a beam diameter of 90 mm. A warning label is attached to the front of the instrument (see 2.6). Class 1M radiation is regarded safe except when viewed with telescope optics. The instrument may only be operated in a protected outside area. The following precautions must be taken when operating the sensor:

- Never view the laser beam with optical instruments, especially binoculars
- Avoid looking directly into the laser beam
- Do not operate the instrument with the inner sensor door open
- Do not operate the sensor horizontally (maximum tilt angle 20°)
- Keep the beam path free of reflecting materials

The laser radiation emitted by the sensor is generated by an embedded Class 3B laser. Even short exposure to Class 3B laser radiation can lead to injuries to the eye and skin. Maintenance and service of the sensor may only be carried out by trained personnel. Under no circumstances may the laser be removed from the measuring unit or any protective covers removed!

2.3 Requirements for the personnel

- The CHM 15k may only be installed and commissioned by trained personnel who have received instructions in safety-related matters. Electrical connection of the device may only be carried out by a qualified electrician.
- Maintenance and adjustment work on the CHM 15k may only be carried out by the service staff of OTT HydroMet Fellbach GmbH or by the customer's authorized and trained personnel. All maintenance work requires a technical qualification in electrical safety.
- Every person assigned to install and commission the CHM 15k must have read and understood the complete user manual.
- During all work on the equipment, personnel must not be overtired and must not be under the influence of alcohol, medicines or intoxicants. The personnel must have no physical limitations that temporarily or permanently restrict their attention and judgment.





2.4 Safety instructions for transport, installation, commissioning and cleaning

- The CHM 15k may only be loaded and transported in the packed condition and in the transport position (see Figure 5) using suitable lifting gear and transport equipment.
- Inside the shipping container / truck the CHM 15k must be adequately protected against slipping, shock, or other mechanical impacts, e. g. by using straps.
- If the CHM 15k is not installed immediately, it must be stored so as to be protected from external influences and adequately secured.
- At least two people are required to install the CHM 15k.
- Once the CHM 15k has been installed, it must be checked. Make sure that no safety-related changes have taken place on the device.
- The inner housing door may only be opened by the service staff of OTT HydroMet Fellbach GmbH or by the customer's authorized and trained personnel.
- Never operate the sensor if a cover window is broken. Return the sensor to OTT HydroMet Fellbach GmbH for repair.
- Explosion hazard: do not install the CHM 15k in hazardous locations.
- Specific notes UPS option (details in chapter 3, 5, 6, 7, 10)

- Do not store the device for more than three weeks after it arrives at your place. For storage beyond three weeks, please connect the device to the mains and switch it on. By doing so, you will significantly increase the life of the battery.
- Switch on the UPS before connecting the device to the mains.
- The battery may only be replaced by trained and qualified personnel.
- The device can only be transported with a valid additional label for lead batteries on the transport packaging in accordance with international transport requirements.

2.5 Description of the notes and symbols



2.5.1 Description of warning symbols

Symbol	Use
	Warning of a general hazard
	Warning of laser beam
	Warning of dangerous electrical voltage
	Warning of hot surface
	Electrical equipment marked with this symbol may not be disposed of in European domestic or public disposal systems. Return old or end-of-life equipment to the manufacturer for disposal at no charge to the user.

2.5.2 Description of precautionary statements

⚠ WARNING
Indicates a hazardous situation that, if not avoided, could result in death or serious injury.
⚠ CAUTION
Indicates a hazardous situation that, if not avoided, could result in minor or moderate injury.
NOTICE
Indicates a situation which, if not avoided, may cause damage to the instrument. Information that requires special emphasis.

2.5.3 Symbols used

-  Remarks for the smooth use of the equipment
-  Required action step

2.6 Product labeling CHM 15k

In Figure 1 the product labels are shown. The type plate and the grounding connection are located on the back of the housing foot.

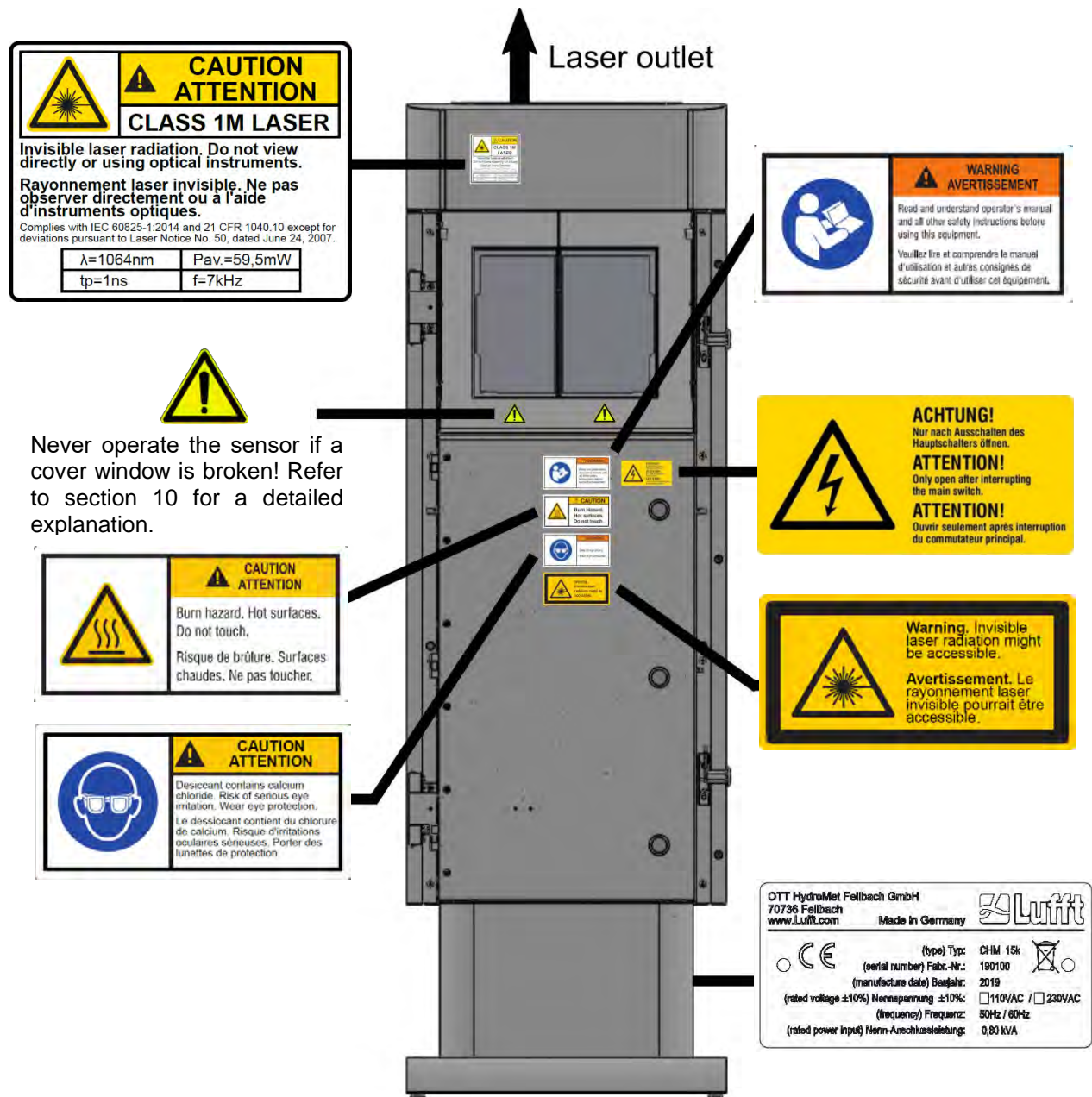

Figure 1 Labeling, the type plate is fixed on the back side of the pedestal.

2.7 Designated use

The operational safety of the CHM 15k is only guaranteed if used as designated in accordance with the instructions in this operating manual.

The device is designed for single phase operation on a public low-voltage network in accordance with IEC38, 6th edition, 1983.

The ceilometer may be used only in a protected outside area. In standard operation, the laser beam is aligned to the zenith, i. e. the device measures vertically. It can be tilted with adequate accessories to a maximum tilt angle of 20°. Any use beyond this limit is considered non-designated use! The operator bears sole responsibility for any resulting damage.

Horizontal use represents a safety risk for third parties and is expressly excluded.

For trouble-free operation, follow a regular cleaning and maintenance cycle (see chapter 10).

Unauthorized modifications to the device are not permitted and will immediately void all warranty claims.

In such cases, no liability whatsoever is accepted for consequential damage.

3 Technical Data

3.1 Ordering information

Equipment Versions			
Order number	Description	Power supply	Cable length
8350.00	CHM 15k Base	230 VAC \pm 10%	10 m
8350.00-BAT	CHM 15k EU + UPS	230 VAC \pm 10%	10 m
8350.01	CHM 15k + DSL Modem	230 VAC \pm 10%	3 m
8350.10	CHM 15k US/CA Base	115 VAC \pm 10%	10 m

Table 1 Standard device variants; special configurations upon request

Remark: The preferred standard cable length is 10 m for the RS485, LAN and power cable. DSL, battery backup (UPS) are options and available upon request for the 115 VAC device version.

3.2 Technical data

Measurement parameters	
Measuring range	0 m ... 15 km (0 ... 50000 ft)
Cloud detection range	10 m ... 15 km (33 ... 50000 ft)
Resolution (measured)	5 m
NetCDF data resolution (*)	5 m – 30 m in 5 m steps (can be set by the user) 15 m (default setting)
NetCDF high resolution data	5 m (defined for limited HR vector of data)
Logging time and reporting cycle (*)	2 s to 600 s (programmable) Default value: 15 s
Measurement objects	Aerosols, clouds (droplets, ice crystals)
Measured parameters	Backscatter data (β_{att} , β_{raw}) Cloud heights up to 9 layers including penetration depth, max. detectable range (MXD), vertical visibility (VOR), Sky Condition Index (SCI), cloud cover (TCC, BCC), ...
Measuring principle	Lidar (optical, time of flight)
Optical parameters	
Light source	Nd:YAG solid state laser, diode pumped
Wavelength	1064 nm
Output power P_{avg} (max)	59.5 mW
Pulse repetition rate	5-7 kHz
Pulse duration	1 ns
Laser divergence	<0.5 mrad
Filter bandwidth	1 nm
Long-time stability over 12 months (pulse repetition rate)	<10 %
Field-of-view receiver (FOV)	0.45 mrad
Data interfaces	
Standard interfaces	RS485 half duplex (ASCII); LAN (http, (S-)FTP, NetTools)
Optional interfaces	DSL, RS232 (service)

Electrical parameters	
Power supply	230 VAC $\pm 10\%$ or 115 VAC $\pm 10\%$
Line frequency	50 Hz, 60 Hz
Power consumption (total)	Max 800 VA with activated case heater (default); Max 300 VA without activated case heater
Power consumption heater	LOM heater: 250 W @115 / 230 VAC Case heater: 450 W @115/ 230 VAC
UPS functionality (optional)	Integrated battery and charger, battery supports measuring electronics and communication
Equipment safety	
Environmental requirements	ISO 10109-11
Laser Protection Class	1M according to IEC 60825-1:2014; complies with 21 CFR 1040.10 Extended NOHD: 1 km (for 50 mm aperture)
Electrical Safety	IEC 61010-1 (TUEV Rheinland certified) UL 61010-1 (TUEV SUED certified) AS 61010.1 (Australia and New Zealand) CAN/CSA-C22.2 No. 61010-1 (TUEV SUED certified)
Protection housing	IEC/ EN 60529: IP 66; IEC/EN 61010-1: IK06 (1 Joule) UL/CSA 50/50e: Typ 4X (tests ongoing)
Protection electrical safety	Protection class I (protective earth needed)
Overvoltage Category	II
Pollution degree in IP66 housing	2
EMC	EN 61326-1: - Immunity class industry - Radiation class residential areas FCC: 47 CFR Part 15, Class B
Conformity	CE, (UL/ CSA housing tests ongoing)
Operating conditions	
Temperature range	-40 °C to +55 °C (in operation, valid for all options) -40 °C to +60 °C (storage)
Relative humidity	0% – 100%
Wind	60 m/s
Maximum operating altitude	5000 m standard units 2000 m with DSL as well with UPS option
Dimensions	
Enclosure dimensions (footprint x height)	W x H x L = 0.5 m x 0.5 m x 1.55 m
Packaging dimensions	W x H x L = 0.75 m x 0.86 m x 1.80 m
Weight	
Weight	70 kg (complete system)
	9.5 kg (measuring unit – heaviest replacement part)
Installation requirements	
Suitable low-voltage distribution systems	TN-S system: grounded mains, grounded CHM 15k enclosure, neutral and protective conductor fed separately and connected separately in device TN-C-S system: grounded enclosure CHM 15k, neutral and protective conductor combined in one conductor outside of the

	device, but fed separately and connected separately in the device.
Connection type	Fixed connection, grounding by means of ground connection clamp (see Figure 12)
Resources to be provided by the operator	
Lightning protection	- Internal lightning protection is provided - External lightning protection must be provided
Grounding	Grounding system according to DIN V VDE 0185-3
Requirements for installation	- Isolation device for disconnection from low-voltage network in close proximity to the CHM 15k - Easily accessible - Marked as belonging to the CHM 15k - Pre-fuses: 10 A gG time-lag

Table 2 Technical data.

(*) the combination of high temporal and range resolution over the full range is limited due to file size and processing time. Any combination of >70MB daily NetCDF file sizes is not supported by Lufft.
 Example (default): 15 m range resolution over full range of 15 km with 15 s time resolution results in a daily 24 MB NetCDF file size (22.5 MB backscatter data array).

Information UPS functionality	
Nominal voltage	12 VDC (Input, Output, battery)
Battery technology	VRLA AGM HPPL
Battery capacity	5 Ah
Load current	2.2 A; a battery management system and intelligent charging electronics protect the battery from over-discharge and deep discharge
Bridging time in case of power failure	1 h over all operating conditions (fixed parameterized)
Service recommendation	After three years, it is recommended to record the condition of the battery using the charging electronics. This is only permissible by trained and expert personnel.
Service life note	<p>The service life of the battery depends on many conditions, whereby the following are decisive during operation:</p> <ul style="list-style-type: none"> • The length of the mains interruption • The frequency of the mains interruption • Operating temperatures below -20 °C • Operating temperatures above 40 °C <p>From these four influences, it is not possible to predict the service life of the battery without doubt for each individual case. We therefore give examples to serve as a guide. Unfortunately, irregular mains failures with different downtimes cannot be represented in examples.</p> <p>It should be noted that the following information on service life expectancy is of a conservative nature. The following service life expectations can also be exceeded in field operation. However, this cannot be guaranteed.</p>
Expected service life of the battery	<ul style="list-style-type: none"> • 1.6 years over all operating conditions and one power failure per day for 5 min • 4.6 years with restricted operating temperature range from -20 ... 40 °C and one failure every 5 days for 5 min • 9.2 years with constant operating temperature at 25 °C and one failure every 5 days for 5 min • 5 years with restricted operating temperature range from -20 °C to 40 °C and one failure per quarter for >1 hour

Table 3 UPS – information about the optional backup battery

4 Technical Description

The CHM 15k ceilometer is mainly used to measure cloud bases, cloud penetration depths, cloud cover statistics, the vertical visibility and the aerosol layer. The calculated data are transferred by remote transmission via standard digital interfaces.

The CHM 15k uses the lidar method as a measuring principle (Lidar: light detection and ranging): short light pulses generated by a microchip solid state laser are emitted into the atmosphere where they are scattered by aerosols, droplets and air molecules. The portion of the light that is scattered back to the ceilometer is further analyzed. The propagation time of the laser pulses is measured and used to calculate the distance of the scattering event.

The height profile of the backscattered signal is analyzed to calculate the backscatter intensity β_{raw} as the first output parameter from the instrument. From β_{raw} the attenuated backscatter coefficient β_{att} can be calculated using a calibration constant valid for the CHM 15k instruments. The different target parameters like the cloud base layers and the aerosol layer height are calculated from these data.

The CHM 15k Nimbus detection system is based on a photon counting method. It can only be used in combination with a laser like it is integrated in the CHM 15k. The narrow laser bandwidth enables the usage of a 1 nm (or less) bandwidth filter in front of the detector that is required to suppress the background light efficiently and be able to average data over several minutes. Averaging signals to reach a certain signal to noise level is key for lidar measurements generating aerosol profiles. Compared to analog measurement techniques, the benefits of this method are very high detection accuracy and sensitiveness. The technique is also robust against noise.

The CHM 15k ceilometer is:

- a compact device including heater and window.
- Capable of operating under the ambient conditions specified in the technical data (see 3)
- Based on modules, e. g. the laser optical module (LOM) inside the device can be replaced (refreshed) at the end of the laser diode lifetime
- a device designed for 24/7 continuous operation
- a device communicating via serial or LAN interface (optional DSL modem interface)

4.1 Construction of the CHM 15k

The enclosure of the CHM 15k is made of corrosion-resistant aluminum in double-shell construction. The function of the outer shell is to dampen the external influences of:

- Solar radiation
- Wind
- Precipitation
- Mechanical shock

on the inner shell, which carries the measuring unit. The chimney effect between the outer shell and the inner housing supports this process and avoids high temperature in the inner housing.

The housing cover protects the inner housing against dust and precipitation and mechanical damage on the windows. The housing cover contains the opening for laser exit and laser entry. The partition in the cover decouples the transmission area from the sensitive receiving area. An air baffle inside the cover directs the airflow from both fans directly onto the glass windows of the inner housing.

The inner housing incorporates all the equipment needed to operate the CHM 15k. The cable feed-throughs for data line, power supply and connection of the external fans are realized via cable glands. For pressure equalization, 3 pressure balancing elements (Goretex®) are integrated in the inner housing.

The upper end of the inner housing forms a two-part viewing window made of float glass. The windows are inclined at the Brewster angle. This ensures low-loss laser light transmission and optimal self-cleaning of the windows. The fan located at the rear of the device supports the cleaning of the windows: the fans are switched on an hourly interval and in rain / snow. The fans are also used to remove heat from the inner housing. The fans are serviced by a service technician via the removable rear panel of the CHM 15k. The outer door allows access to the inner housing and the glass windows, e.g. for cleaning purposes. Access to the interior of the inner housing is possible via the inner door. The outer and inner doors are secured with different locking mechanisms. In this way, access to the interior of the inner housing by cleaning personnel who have not been instructed in safety-related matters is excluded. The inner door may only be opened by the service staff of OTT HydroMet Fellbach GmbH or by the customer's authorized and trained personnel.

4.2 Functional units of the inner housing

The functional units of the device are:

- Transmitting and receiving unit (measuring unit - LOM)
- Control board and related components
- Power supply 12 - 15 VDC for the electronics
- Transformer based DC power supply with 48 VCD for fans
- Housing fan and temperature sensors
- Lightning and overvoltage protection devices for power cable, LAN, RS485
- USP - Battery backup module (optional) for buffering of main failures up to one hour

The functional units are of modular design, fastened separately to the inner housing and can be removed and replaced individually for servicing purposes.

4.2.1 Functional diagram

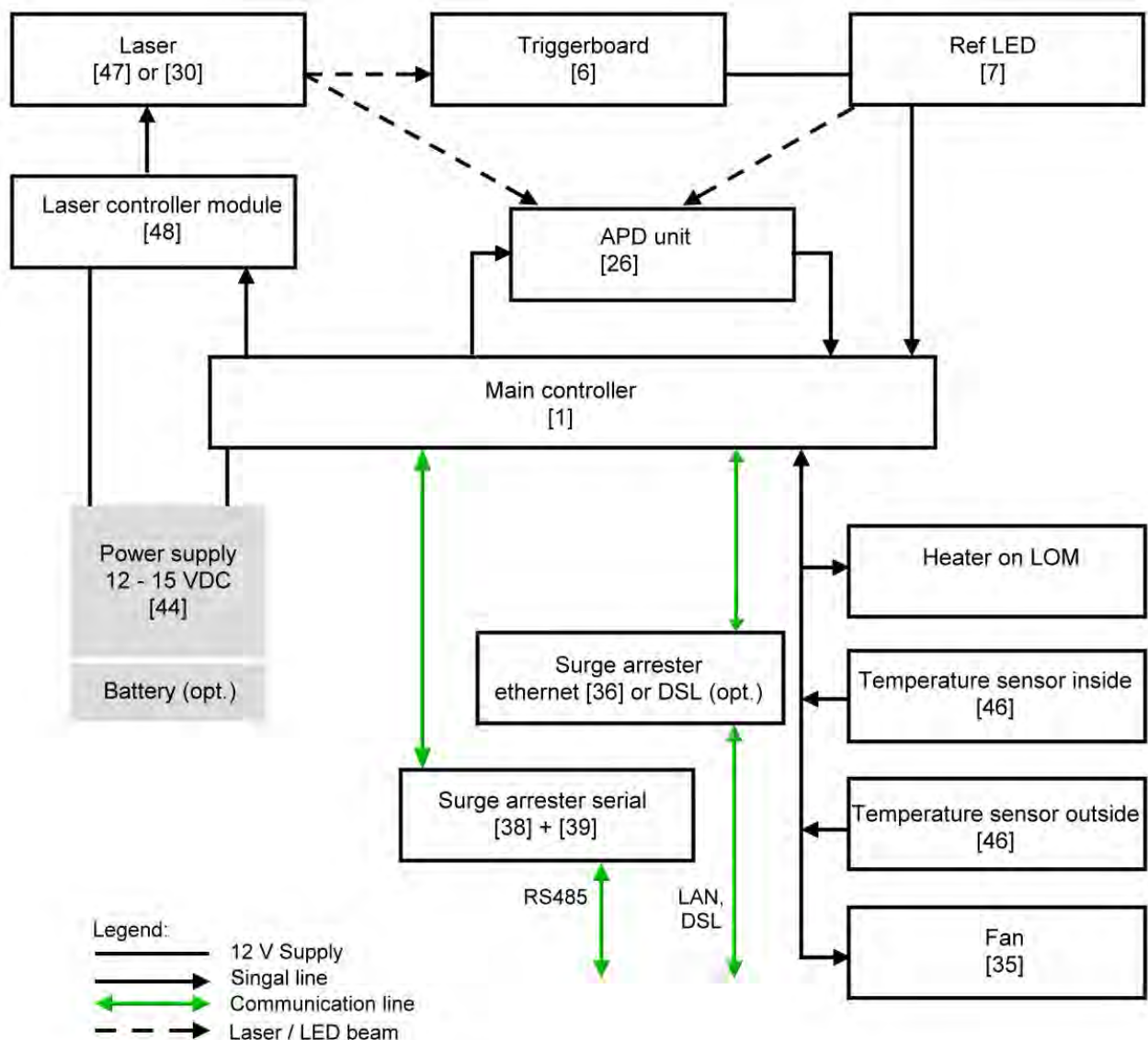

Figure 2 Functional chart, the numbers in brackets corresponds to the numbering in the spare parts list (provided in the service manual or as an extra list).

Figure 2 clearly shows that the main controller is the central unit. The main controller controls and monitors all device functions shown here and provides corresponding status values.

4.2.2 Function control and device status

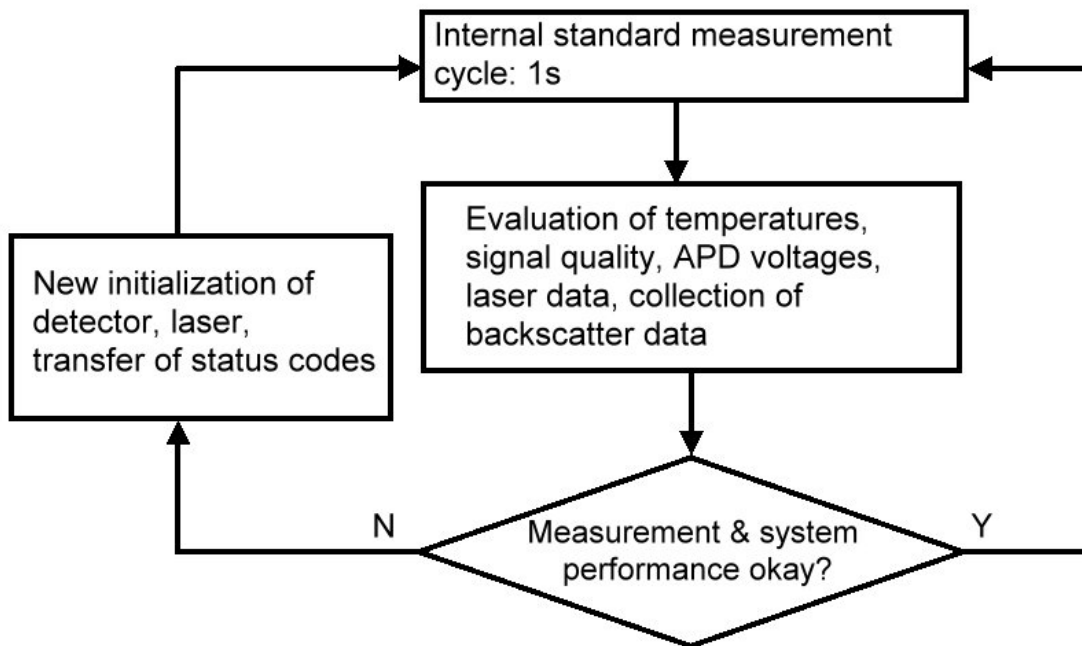

Figure 3 Flow Chart - standard measuring cycle.

The functional control of the CHM 15k (measurement and evaluation) is performed by an FPGA and an OMAP processor. The logging interval (not shown here) consist of multiple measuring cycles calculated in the OMAP processor, while processes with higher time resolution of up to 1s time intervals are processed in the FPGA.

Figure 3 shows the internal measurement cycle that takes place every second. The measured data and the evaluation of the status parameters are checked after each measurement cycle. If the values are outside the tolerances or there is a hardware error, the standard measurement cycle is reinitialized, and an error message is generated and output.

However, there are parts that are read out and controlled with higher time resolution, such as the temperature control or that run in the logging time interval, such as the evaluation of the window contamination and the fan controller in case of precipitation.

The state of the receiver depends on the results of monitoring noise level, supply voltage and DC-current with and without a test pulse. Due to its internal setup, the light source is essentially characterized by the pulse repetition rate, which may decrease because of light source aging. The pulse rate is subject to monitoring. For pulse rates below 4.5 kHz, an error message is generated. The light pulse reflection from the window panel is also analyzed to monitor the window contamination. All obtained values are reported in data telegrams and are part of the NetCDF files. In addition, there is a software watchdog to control the firmware processes. Determined values and status values are output in the extended data telegram and the NetCDF files. The standard message contains rough information about the status code (see 8.5).

5 Transport / Scope of Delivery

NOTICE

The device may be damaged if handled inappropriately.

- ⇒ The CHM 15k may only be transported and moved using suitable transport equipment and lifting gear.
- ⇒ The CHM 15k may only be loaded and transported in the packed condition and in the transport position (see Figure 5).
- ⇒ Inside the shipping container / truck, the CHM 15k must be adequately protected against slipping, shock, or other mechanical impacts.
- ⇒ If an optional UPS is installed, a special transport label must be attached to the outside of the transport box in a clearly visible position in accordance with the international transport conditions valid at the time of transport.

The scope of delivery includes:

- CHM 15k ceilometer
- Grounding cable 2.6 m
- Ring binder with documents
 - Drilling template
 - Mechanical setup instruction
 - Electrical setup instruction
 - Test protocol
 - List of serial numbers of build in components
 - User manual and USB stick with communication software
- Fastening components:
 - 4 dowels S12 (Fischer Co.)
 - 4 screws M10 x 140-ZN (DIN 571)
 - 4 washers ISO 7093-10.5-KST/PA
 - 4 washers ISO 7093-10.5-A2

On customer's request:

- An adapter frame can be supplied, which allows the CHM 15k to be screwed to existing fastening bolts.
- An angle adapter frame can be supplied, e. g. for 15° to tilt ceilometer away from direct sunlight.



Information about required tools

Spanner / wrench for 4x M10 screws: 17 mm or 3/8 Whitworth. A 3/8-inch screw with appropriate anchors can be used instead of the M10 screw. The leveling screws require a 22 mm spanner or 1/2 Whitworth.

For further technical details, please contact OTT HydroMet Fellbach GmbH.

Operating status of the CHM 15k on delivery

Transfer mode	1, automatic output of the standard data telegram
RS485 device number	16
Baud rate	9600
Measuring period	15 seconds
Optional UPS	Switched off (Switch position down, see

For detailed information on the operating statuses, see 8 Communication via RS485 & Ethernets

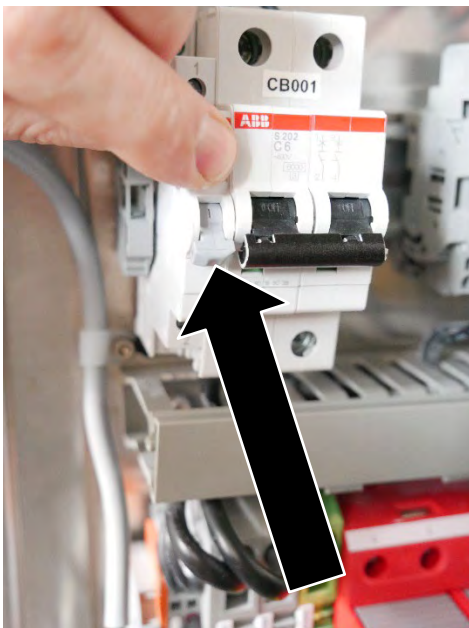

Figure 4: Switch position "UPS off"

6 Installation

NOTICE

- ⇒ The operator of the CHM 15k is responsible for creating and dimensioning the foundation. The foundation must be dimensioned so that it can cope with the permanent stress caused by the weight of the equipment and external influences.
- ⇒ To prevent the ingress of dirt or moisture, the device must not be opened during installation and commissioning.

The CHM 15k ceilometer is installed on and fixed to a suitable concrete foundation. Integrated leveling screws on the underside of the foot allow the device to be vertically aligned and thus facilitate the vertical orientation of the measuring unit.

Install the CHM 15k in a protected outside area. Avoid radiation from strong light sources. The sun radiation angle must be $\geq 15^\circ$ to the vertical. Please request a suitable angle adapter. The distance to trees and shrubs must be selected such that leaves, and needles do not reach the light emission apertures of the device. When installing the CHM 15k, the following minimum distances must be observed:

- to radio devices 2.5 m
- to stationary transmitters / base stations (≥ 100 W transmission power) 25 m
- between two ceilometers (optical interference possible) 10 m

6.1 Installing the CHM 15k

6.1.1 Preparatory work

The CHM 15k requires an installation area of 50 x 50 cm. It must be stable, firmly installed and mounted on an adequately sized concrete foundation. The inclination of the installation surface must not exceed 5 mm/m. Before installing the CHM 15k, holes must be drilled and dowels inserted in the concrete foundation (\varnothing 12 mm, 4 dowels are included in the delivery), in accordance with the drilling template (see Figure 4). It is important to pay attention to the opening direction of the exterior door to the operator's connection box.

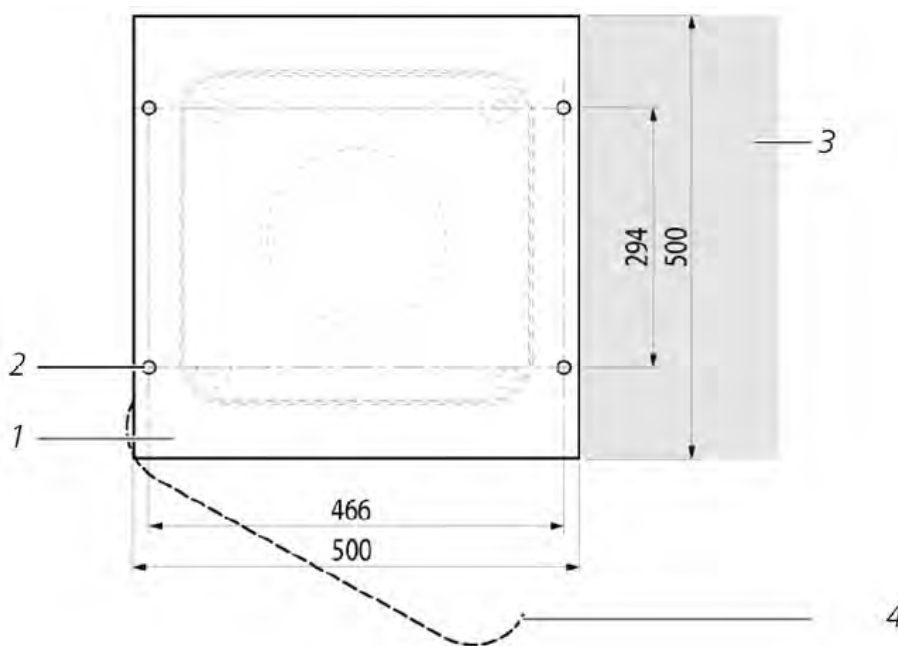



Figure 5 Drilling template.

- 1 Drilling template
- 2 Drill holes (\varnothing 12 mm) for fixing
- 3 Possibility of electrical connection (connection box)
- 4 Opening direction of the exterior door

6.1.2 Installing on the foundation

⚠ CAUTION	
	<p>The CHM 15k weighs 70 kg, heavy equipment may cause serious injury.</p> <ul style="list-style-type: none"> ⇒ Do not attempt to move the CHM 15k without adequate help ⇒ At least two people are required to install the ceilometer

Install the CHM 15k ceilometer as follows:

- ⇒ Unload the CHM 15k from the transport equipment and set it down as close as possible to the place of installation. The position of the base of the instrument inside the transport crate is marked with "Boden / Base" on the crate.



Figure 6 CHM 15k packed and in transport position (1: wooden crate, 2: pallet).

- ⇒ Loosen the clamps on the cover plate (use a flathead screwdriver of suitable width).
- ⇒ Lift the cover plate upwards and set aside.
- ⇒ Remove the clamps of the side walls and put panels aside.

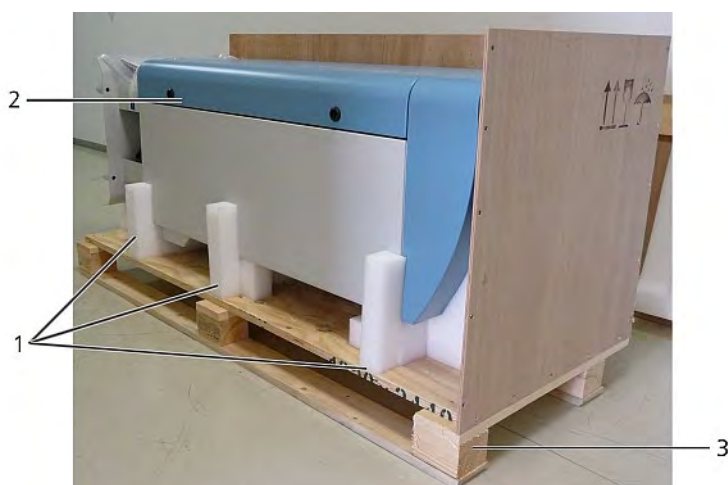

Figure 7 CHM 15k with Styrofoam or paper honeycomb packing pads.

- 1 Here: Polystyrene packaging
- 2 CHM 15k
- 3 Pallet

- ⇒ Carefully lift the CHM 15k out of the polystyrene or paper honeycomb packaging by hand, observing all safety regulations. (Lifting positions: Figure 7)

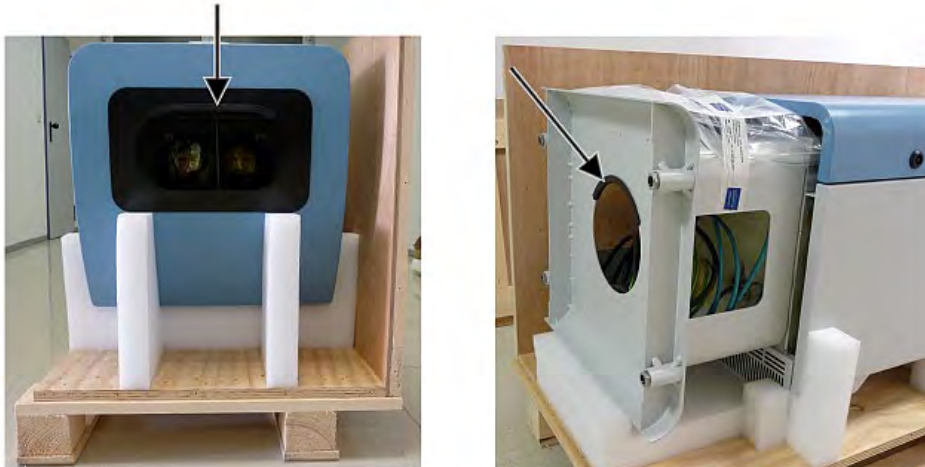

Figure 8 Lifting positions and handle protection (edge protection profile).

Onward transport options:

- ⇒ To carry: Grasp the equipment in the openings marked with arrows (Figure 7)
- ⇒ Hand truck: For greater distances to the concrete foundation (Figure 8)

NOTICE
<ul style="list-style-type: none"> ⇒ When transporting with a hand truck, make sure that the CHM 15k is placed on the hand truck with the exterior door facing downwards (see Figure 8) ⇒ A cushion (e. g. bubble wrap) should be placed between the CHM and the hand truck



Figure 9 Transport with hand truck.

- ⇒ Position the CHM 15k in the installation position (vertical) on the concrete foundation. It is important to pay attention to the position of the exterior door in relation to the operator's connection box (see Figure 4)
- ⇒ Loosely pre-assemble the CHM 15k on the concrete foundation with the supplied washers and fixing screws (see Figure 9)

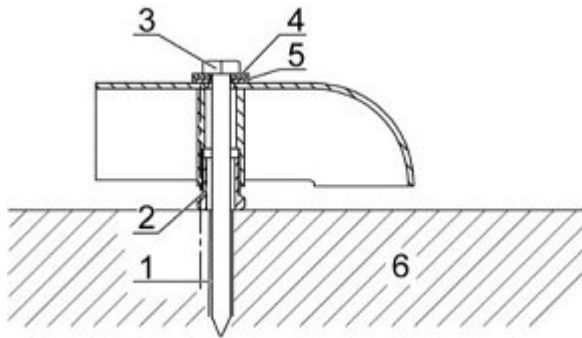

Figure 10 Fixing elements.

- 1 Dowel S12
- 2 Leveling screw 5 mm (integrated into the base of the device)
- 3 Screw DIN 571-10 x 140-ZN
- 4 Washer ISO 7093-10.5-A2
- 5 Washer ISO 7093-10.5-KST/PA
- 6 Concrete foundation

- ⇒ Vertically align the CHM 15k using the levelling screws integrated into the base of the device (with a spirit level: place on one side wall and on the front). Tools required: 22 mm spanner / wrench.
- ⇒ Tighten the fixing screws. Tools required: 17 mm spanner / wrench.
- ⇒ Remove the handle protection (edge protection profile) from above and secure in the base for the next transport.

6.2 Electrical installation

NOTICE

Incorrect installation may result in damage to the equipment.

- ⇒ The electrical connection of the CHM 15k may only be carried out by a qualified electrician of OTT HydroMet Fellbach GmbH or another qualified electrician. Failure to comply will result in the loss of warranty and warranty claims.
- ⇒ In case the optional UPS system is available: Activate the UPS functionality before the electrical installation (see Figure 10).
- ⇒ The operator must meet all the requirements for connecting the CHM 15k ceilometer in accordance with EN 61010-1, e. g. installation of a connection box
- ⇒ An overvoltage and lightning protection system is installed within the Ceilometer. If the



Figure 11: Switch position up for UPS on

Figure 10 shows a schematic sketch of the electrical installation of the CHM 15k. The power supply (1) to the device must be connected via an external mains switch (2) which needs to be easily accessible to cut the power to the device when required. It must be marked as belonging to the CHM 15k and two pre-fuse 10A gG time-lag must be used. The connection box should be installed at a distance of < 3 m. An external lightning conductor (7) must be installed to protect the device from direct lightning strikes. All connections to the device must be made according to the respective country-specific regulations.

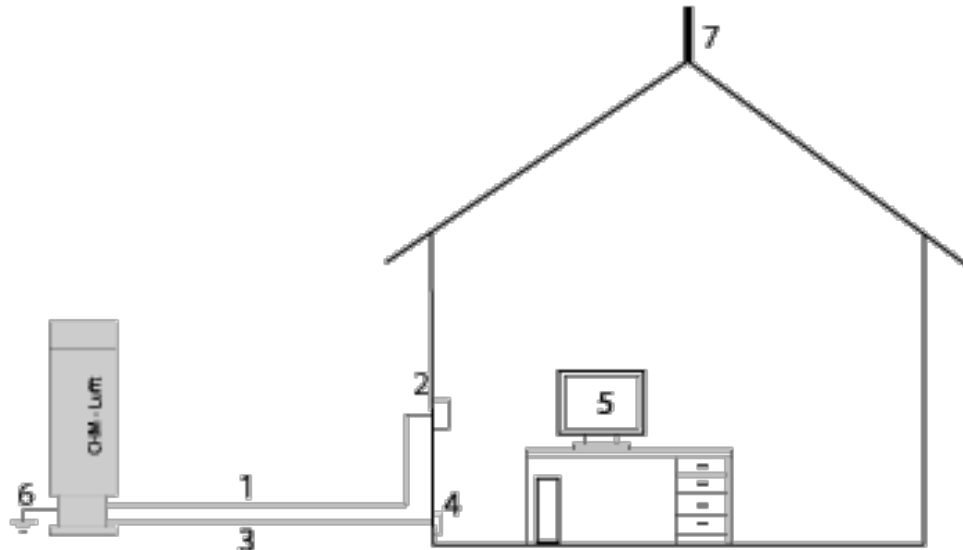



Figure 12 Schematic sketch of the electrical installation.

- 1 Power supply cable (3 pole)
- 2 Mains switch and electric junction box
- 3 Data transfer cables: RS485, LAN or DSL
- 4 Data cable connection: RS485, LAN or DSL
- 5 PC for remote access (via LAN/DSL; PC must not be local)
- 6 Earth connection ceilometer
- 7 Lightning conductor

⚠ WARNING	
	<p>Touching live parts may result in electric shock, which will cause serious or fatal injury.</p> <p>⇒ Switch off the external circuit breaker before starting the installation and secure against reconnection.</p>

The electrical connections to the CHM15k are specified in more detail in Figure 11. Connect the mains and data cables as shown in this figure. It is recommended to include external overvoltage protection in all connections to the device to prevent damage to the connection box. Internal lightning protection is provided in the device.

The CHM 15k is connected via the following supplied cables:

1. 230 VAC supply cable (mains cable); color code: neutral conductor: blue, conductor: brown, protective conductor: green-yellow; standard length 10 m.

OR

115 VAC supply cable (mains cable); color code: conductor: black, neutral conductor: white, protective conductor: green / green yellow

2. Grounding cable 10 mm² (1-pin, green-yellow), standard length 2.6 m, for the grounding connection (see Figure 12). The grounding cable must be kept as short as possible



Figure 13 Grounding Connection.

3. Data cable (RS 485, 3 wire): A (-) conductor: yellow; B (+) conductor: green; RS485 - GND: white & brown; shielding as required: (see Figure 13); standard length 10 m

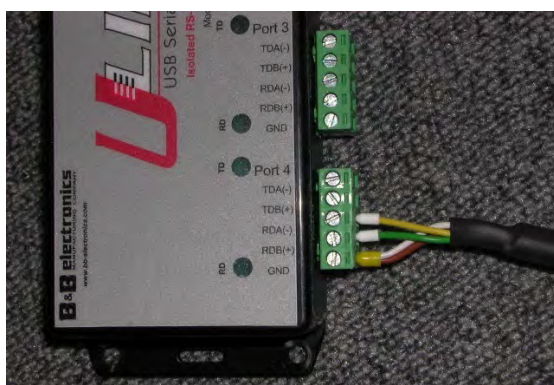

Figure 14 RS485 connection to transducer.

4. Data cable (LAN): equipped with a standard RJ45 plug, for connection to a remote computer, hub or switch, standard lengths 5 or 10 m. (see Figure 14)
5. Optional instead of item 4: Data line (DSL): equipped with a 2-pin cable for the connection of a DSL modem (see Figure 14)

The designation RDA (-), RDB (+) is defined differently by manufacturers. Here: Lufft uses the notation of B&B electronics.

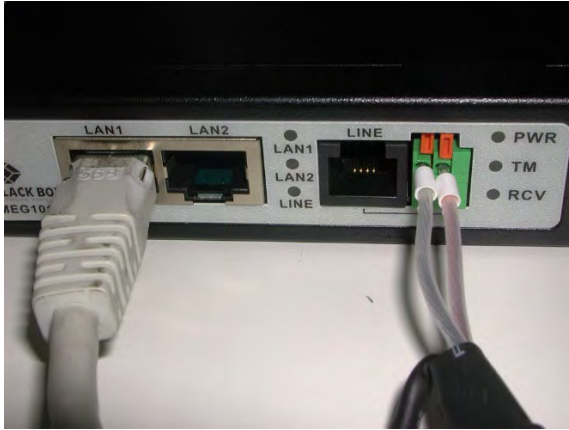

Figure 15 DSL connection.

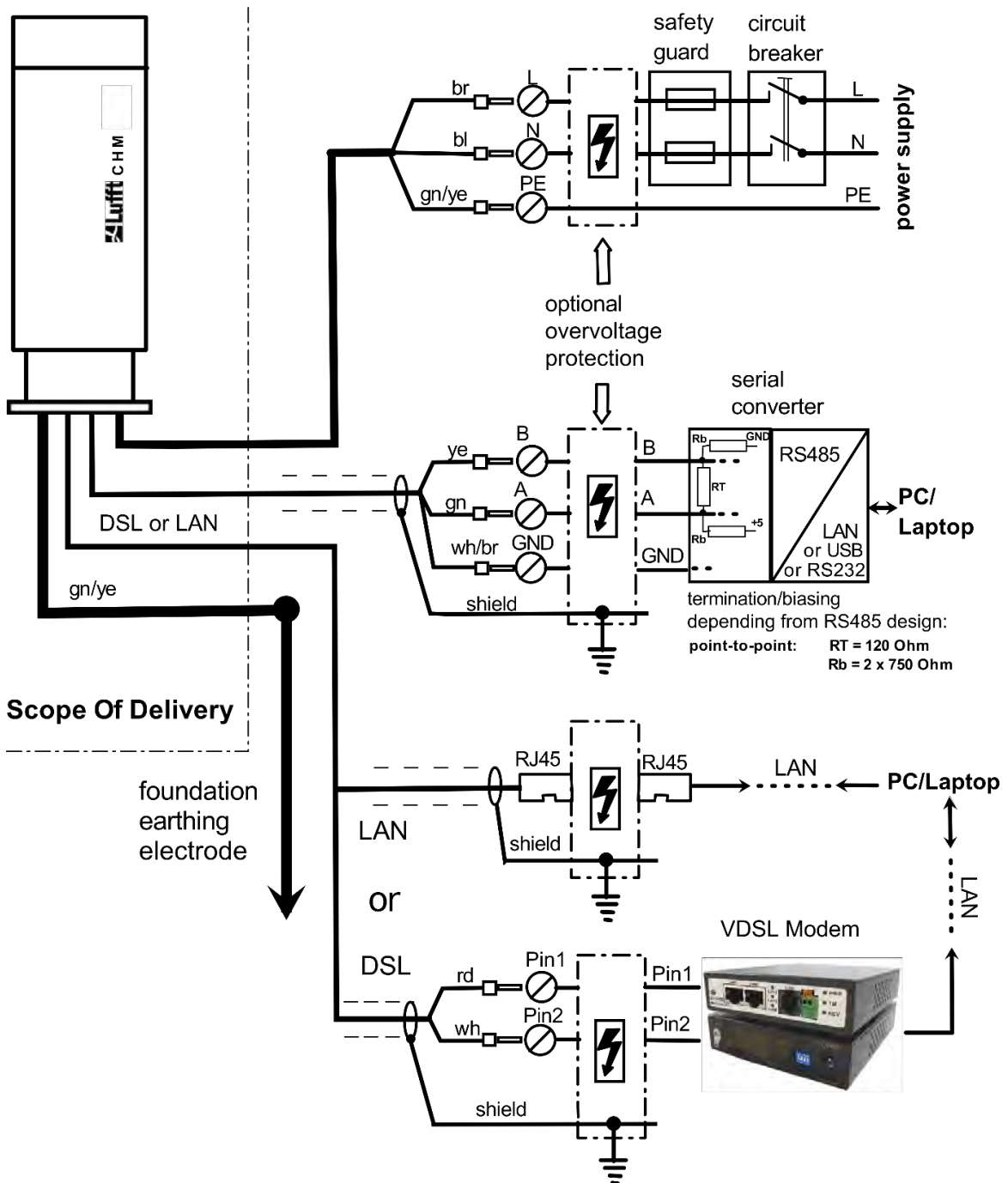



Figure 16 Electrical installation.

7 Commissioning and Decommissioning

7.1 Starting up with the RS485 connection

Requirements:

- The CHM 15k ceilometer must be installed correctly.
- The UPS system (optional) is switched on (section 6.2).
- Control cable (RS485), grounding cable and mains cable (115 VAC or 230 VAC) must be connected
- A terminal program, e. g. HyperTerminal or Bray's terminal, can be used under Windows, for testing the communication. It has to be configured for communication as follows:
 - Baud rate: 9,600
 - Data bits: 8
 - Parity: none
 - Stop bits: 1
 - Flow control: none

⚠ CAUTION	
	<p>After switching on the power supply, the CHM 15k emits Class 1M invisible laser radiation through the opening at the top of the sensor. When viewed with optical instruments, Class 1M radiation can lead to serious eye injuries.</p> <ul style="list-style-type: none"> ⇒ Never view the laser beam with optical instruments, especially binoculars ⇒ Avoid looking directly into the laser beam

After connecting the supply voltage, the CHM 15k will start up by itself. The optional UPS system is active. During the start-up process an internal self-check is done, e. g. the fans start for a few seconds. Communication with the device is possible within 1 minute. The CHM 15k will be fully operational after a temperature adjustment phase of varying length depending on outdoor temperature conditions. The time until measurement data are available in high quality, can be between 2 minutes (warm start) and one hour (cold start at -40 °C).

The CHM 15k automatically send out standard data telegrams when start up procedure is ready. It is part of the default setup and might differ for user specific CHM 15k start settings. The automatic output every 15 s is helpful to check if the communication works correctly without entering any command.

To change the start-up behavior like polling vs auto mode or the telegram that should be used at start see chapter 8 Communication via RS485 & Ethernet.

Test commands for RS485 communication

To test the communication, use the command (RS485Number = 16 (default value):

set<SPACE><RS485Number>:Transfermode=0<CR><LF>

This changes from auto to polling mode. Testing in polling mode is helpful to avoid interruptions by automatically sent out telegrams while typing. 9 telegram types are available:

- Standard data telegram (short name: 1 or s)
- Extended data telegram (short name: 2 or l)
- Raw data telegram (short name: 3 or a)
- User telegrams (short names: 4, 5, ..., 9)

Section 8 describes the possible commands and their effects in detail. Some commands for functional testing required in routine operation or to setup the system in the beginning are listed in Table 3.

Command	Description	Response (shortened)
get<SPACE>16:L<CR><LF>	Output of extended data telegram	see 8.3.4
set<SPACE>16:RNO=14<CR><LF>	Set the RS485 bus address from 16 to 14	set 16:RNO=14
set<SPACE>16:Baud=4<CR><LF>	Sets baud rate to 19,200	set 16:Baud=4
set<SPACE>16:dt(s)=15<CR><LF>	Sets logging time interval to 15 s	set 16:dt(s)=15
get<SPACE>16:Lifetime(h)<CR><LF>	Readout of the laser operating hour counter	get 16:Lifetime(h)

Table 4 Commands for functional testing (examples).

After completing the simple functional test on the CHM 15k:

- Continue to operate in polling mode, or
- Reset to automatic transmission mode

set<SPACE><RS485Number>:Transfermode=1<CR><LF>

Comment: This command leads back to the automatic transmission mode of the standard telegram "1".



Baud rate with raw data transmission

The baud rate settings must be observed, especially in RS485 bus mode. If raw data transmission is required, each telegram will have 12 kB in size or more. To reduce the transmission time between two 15 s telegrams the baud rate shall be set to at least 19,200 baud.

7.2 Starting up with the LAN connection

In addition, or as an alternative to the RS485 connection, a LAN connection (Ethernet) can also be used.

Requirement: A connected LAN cable (see 6.2 Electrical installation) or LAN over DSL connection with a DSL transmitter and receiver modem in between.

Configuration: 3 separate IP addresses are available for simultaneous communication:

1. A preconfigured fixed service address to the device
→ 192.168.100.101, subnet 255.255.255.0
2. DHCP server assignment (requires a DHCP server)
3. User address + subnet + gateway, see section 8.7 for the configuration via a LAN / WAN connection to the device and 8.1 and 8.2, if these values are configured with the RS485 interface.

The service address (1) cannot be changed by the user. It is always available and can be used for direct connections between a laptop and the CHM 15k.

One of the 3 IP addresses can be entered into a web browser (Figure 15) for communication with the device. Figure 20 shows the "Config Network" tab in the Internet browser Firefox. Changing the user IP address (3) requires superuser authorization in the device tab.

The superuser password is: 15k-Nimbus

The superuser password can be changed if necessary, see Figure 24.

The web interface was tested with the following web browsers:

- Edge, Internet Explorer 8 or later
- Firefox 3.6 or later
- Google Chrome, Apple Safari

In the DHCP (2) network environment, the CHM 15k is configured automatically. The DHCP mode can be switched off.

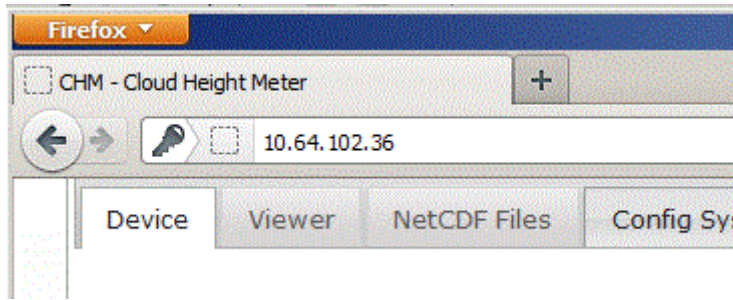

Figure 17 Firefox browser for a connection with the CHM 15k (shown here with fixed IP address).

It is possible to use the RS485 connection and query the DHCP IP address by entering:

get<SPACE><RS485Number>:IPD<CR><LF>.

If available, the device transmits the DHCP address that can be used in a second step in a web browser to connect to the system via a LAN connection.

The user IP address can be set or queried by the user via RS485, too, using the parameter IPS instead of IPD, e. g.:

get<SPACE><RS485Number>:IPS<CR><LF>

set<SPACE><RS485Number>:IPS=xxx.xxx.xxx.xxx<CR><LF>

For further support regarding communication please contact OTT HydroMet Fellbach GmbH.

7.3 Shutdown

Advanced users should first shut down the device before disconnecting it from the power supply:

⇒ Users with superuser authorization should use the web interface: Log in as a superuser and press "SHUTDOWN SYSTEM" on the device tab

⇒ RS485 users can enter the following command:

set<SPACE><RS485Number>:SHT<CR><LF>

⇒ In both cases the Linux-based system is turned off and measurement data are stored on the local SD card.

After the soft shut down the main power can be disconnected without the risk of data loss.

The UPS system shall be switched off only after complete external disconnection of the main power supply. Switch-off is performed with the breaker position described in chapter 5.

⇒ To uninstall the CHM 15k and reinstall it at a different location, carry out the steps described in sections 6.1.2 Installing on the foundation and 6.2 Electrical installation in reverse order.

7.4 Disposal



Disposal Notice

Disposal of the CHM 15k ceilometer must be in accordance with national regulations. Electrical equipment marked with this symbol may not be disposed of in European domestic or public disposal systems. Return old or end-of-life equipment to the manufacturer for disposal at no charge to the user.

8 Communication via RS485 & Ethernet

The CHM 15k supports the interfaces RS485 (section 8.2) and Ethernet (section 8.7) for communication with the device. Both offer the possibility of data transfer of the measured values and the configuration of the device and can be used at the same time.

A web interface is part of the device for the communication via the Ethernet interface. Regardless of the operating system, the ceilometer can be accessed through various web browsers.

The web interface can also be used to manually download the measured data stored in NetCDF daily files on a built-in SD card (section 8.4). Also implemented on the system is an AFD (ftp) service (section 8.8) which, for example, allows data in the form of 5-minute blocks of NetCDF files to be transferred to an external FTP server.

The RS485 communication requires a terminal program.



Transmit and receive with RS485

The RS485 interface does not allow simultaneous send and receive operation (half duplex mode). Accordingly, the interface is automatically switched internally. Hence, while receiving an automatically transmitted data telegram (see sections 8.3.3 to 8.3.5), it is not possible to send other commands (as described in 8.1).

The incoming start and end flags <STX> and <EOT> indicate a current receive transmission.

8.1 List of configurable parameters

Table 5 contains the most important settings. These are explained in the following sections. To prevent unwanted effects on the functioning of the device, some options can only be set in service mode (RS485) or in superuser or service user mode (Ethernet), such as the device name. Table 6 shows a list of parameters with read-only properties. These parameters are stored in part on the EEPROM on the measuring unit and affect data evaluation and the basic system settings.

The tables contain the permissible value range the maximum character length for each parameter and the default value on delivery of the device. Text-parameter will be cut to their maximum field length. They also contain an indication when the service mode is required or when the parameter availability is different between RS485 and web-interface.

Parameter	Short cmd ^{RS485}	Default value	Range / short description / [max. character length]
AfdMode*	AFD	0	0; 1, switch on the ftp data transfer
Altitude(m)	ALT	0	0 – 9999, unit is always in meters!
ApdControlMode*	ACM	3	0, 1, APD mode, only change if you know what to do
ApdTemp*	APT	30000	Temperature in °C x1000, only change the value after contacting the Lufft service
Azimuth	AZT	0	0-360 degrees (x 100) ^{Web} (e.g. 12.25 ^{RS485} and 1225 ^{Web})
Baud	BAU	3	2 – 7 (4,800 – 115,200 baud)
BaudAfterError*	BAE	3	2 – 7 (4,800 – 115,200 baud)
BlowerMode	BLM	0	0 – 4
ChmTest*	CHT	0	0; 1

Parameter	Short cmd ^{RS485}	Default value	Range / short description / [max. character length]
CloudDetectionMode	CDM	0	Switch for cloud detection mode (0 = standard, 1 = "higher low clouds")
Comment	COM		Comment; also stored in the NetCDF file [31]
Comment 1 ^{RS485}	CM1		Additional comment field [31]
Comment 2 ^{RS485}	CM2		Additional comment field [31]
Comment 3 ^{RS485}	CM3		Additional comment field [31]
Comment 4 ^{RS485}	CM4		Additional comment field [31]
Comment 5 ^{RS485}	CM5		Additional comment field [31]
Comment 6 ^{RS485}	CM6		Additional comment field [31]
Comment 7 ^{RS485}	CM7		Additional comment field [31]
DateTime			UTC Time in the format DD.MM.YYYY;hh:mm:ss ^{RS485} and MMDDhhmmYYYY ^{Web} ..(see Figure 24)
DeviceName*	DVN	CHMyyxxxx	Serial number of the device [31]
DeviceType*	DVT	0	Switch for NetCDF format (Firmware < 1.000: default value CHM15k)
DHCPMode	DHM	1	0;1 switch DHCP mode on / off
DNSServer	DNS		Set / queries IP address of name server [63]
dt(s) ^{RS485} LoggingTime ^{Web}	DTS	15	Logging and reporting time: 5 – 600 s
Gateway	GAT	0.0.0.0	Set / queries the static gateway address [15]
HardwareVersion*	HWV		Device-dependent, see Table 26
HttpPort	HPT	80	Specifies http port to access, the web interface of the ceilometer
IgnoreCHars*	ICH	06	8-bit ASCII codes [31]
Institution	INS	NN	Institution (text) [63]
IPAddress	IPS	0.0.0.0	Set / queries the static IP address [15]
LanPort	LPT	11000	Port for telegram transmission via Ethernet
LanTelegramNumber	LTN	2	Telegram format for Ethernet transmission {1, 9}, see section 8.3
LanTransferMode	LTM	1	Communication mode for telegram transmission via Ethernet (0 = polling; 1 = automatic sending)
LaserMode*	LSM	1	Switch laser on / off
Latitude	LAT	0	-90 to +90 degrees (x 10 ⁶) ^{Web}

Parameter	Short cmd ^{RS485}	Default value	Range / short description / [max. character length]
			(e.g. 52.430210 ^{RS485} and 52430210 ^{Web}) “+” means degrees north
Layer	NOL	3	1 – 9, number of cloud layers
Location	LOC	NN	Alphanumeric string {\ / : * ? " < > _ # %} not allowed [31]
Longitude	LON	0	-180 to +180 degrees (x 10 ⁶) ^{Web} (e.g. 13.524735 ^{RS485} and 13524735 ^{Web}) “+” means degrees east
MaxCrosstalkChars*	MCC	5	0 – 1024
NetcdfMode	NCM	1	Switch for NetCDF format (1 = beta_att, 2 = beta_raw, see 8.4.4) trigger firmware reboot.
NetMask	NMA	0.0.0.0	Set / query the static Netmask address [15]
NtpMode	NTM	1	0; 1 switch ntpd on / off
NtpServer	NTS	0.0.0.0	Set / query the NTP time server address [15]
PeltierMode*	PTM	1	0; 1
RangeEnd	RAE	15345	Last range value in a NetCDF file
RangeHRDim	RHD	32	Number of data points in the height-resolved distance vector
RangeResolution	RAR	3	Number of 5 m range intervals averaged for the NetCDF data vector
RangeStart	RAS	15	First range value in a NetCDF file
Reset	RST	0	0; 1 restart of the CHM (see 8.2.4)
ResetPassword*	RSP	0	0; 1; reset the super user password
ResetSettings	RSG	0	0; 1 reset to the factory settings, (see 8.2.4); web interface: set to factory setting
RestartNetwork	RSN	0	0; 1 writes the new settings in the configuration file and restarts the network
RS485Number	RNO	16	0 – 99 (used with RS485)
ServiceMode ^{RS485}	SMO	0	0; 1 switch to the Service mode to change “critical” values
ShutDown	SHT		0; 1 shuts down the CHM system
StandBy	STB	0	0; 1; Standby mode with standby telegram to reduce power consumption
SystemStatusMode	SSM	0	0; 1; the escalated status code will be used in the telegram if set to 1
TimeOutRs485(s)*	TOR	30	5 – 3600

Parameter	Short cmd ^{RS485}	Default value	Range / short description / [max. character length]
TimeZoneoffsetHours	TZH	0	-12 12 hours, e.g. CET is +1, used to control the window ventilation
TransferMode	TMO	1	0 – 9, see section 8.3
TransferModeAfterError*	TME	1	0 – 9
UAPD*		1	Device-dependent in mV (e.g. 172000)
Unit(m/ft)	UNT	m or 0	m; ft ^{RS485} bzw. 0, 1 ^{Web}
UseAltitude	UAL	0	0; 1
WIGOSStationID	WSI		Set / query the WIGOS station identifier [31]
WMOStationCode	WSC		Set / query the WMO station code
Zenith	ZET	0	0 - 90 degrees (x 100) ^{Web} , 0° is vertical (e.g. 10.25 ^{RS485} and 1025 ^{Web})

Table 5 List of configurable parameters,

* can be set in service mode,

^{Web} format for web interface, or only in web interface available

^{RS485} format for RS485, or only for RS485 available

Parameter	Short cmd ^{RS485}	Default value	Description
APDBreakdown	UBR		Device-dependent (e.g. 400000 mV)
ApdTempGradient	TCO	2400	value for comparison [mV/K]
IPDhcp	IPD		IP address DHCP
LaserPower	LAP		Device-dependent (e.g. 50 mW)
LifeTime(h)	LIT		hours the laser diode is in operation
Parameters ^{RS485}			Delivers a list of all parameters that are available in the RS485 mode
SerLOM	LOM	TUByyxxxx	Serial number of the laser optical module (LOM) [15]
SystemLifeTime(h)	SLT		Total number of all operating hours of the CHM system
TBCalibration	TBC		Scaling factor compared to reference
VersionFirmware	VFI		Firmware version (data processing and handling)
VersionFPGA	VFP		Firmware FPGA
VersionLinux	VLI		Operating system version

Table 6 List of read-only parameters, accessible via the RS485 interface.

^{RS485} only for RS485 available

Explanatory notes to Table 4

AFDMode: Switch on / off the automatic file distribution system via LAN / WAN / DSL, see <http://www.dwd.de/AFD/> for more information or section 8.8.

Altitude(m): Specification of the height of the location above sea level in meters. In NetCDF files, the parameter CHO (Cloud Base Offset) is used instead. Both are logically combining the variables Altitude and UseAltitude.

Azimuth: Specification of the horizontal angle in degrees.

Baud: Change baud rate (see 8.2.3 Changing the baud rate).

BaudAfterError: Default baud rate after communication error (see 8.2.3 Changing the baud rate).

BlowerMode: Used to test the window fans and switch to different operating modes. Mode 2: "rest at night" works only correctly if the parameter TimeZoneOffsetHours is set correctly, too.
0 = hourly check and weather-dependent, 1 = no hourly check from 22:00 to 06:00, 2 = off from 22:00 to 06:00, 3 = always on, 4 = always off.

DataTime: Sets the date and time (see 8.2.5)

dt(s): Logging time interval (in automatic mode identical to the reporting time). A longer time interval leads to time averaging over more photon pulses (shots) and thus to an improved signal / noise ratio. An increase by the factor n leads to an improvement by the factor root n. All raw data in the time interval dt(s) are included in the evaluation. Single data selection does not take place.

DeviceName (old FabName): Device acronym (CHM) combined with the serial number of the device, e. g. CHM060001.

IgnoreChars: Specific 2-character HEX codes, e. g. "06" corresponds to <ack>, can be added to a list of characters that should not be evaluated by the CHM 15k instrument.

Institution: Institution or company.

Lasermode: Switches the laser on / off, useful option for testing.

LaserPower: Laser power in mW.

Latitude: Latitude of the location, decimal, example Berlin: 52.51833 (corresponds to 52° 31' 6" N).

Layer (Number of Layers): Number of cloud layers displayed in the extended telegram and NetCDF file.

Lifetime(h): Queries the operating hours of the laser (laser lifetime).

Location: Sets / queries the location of the device. The name of the device is limited (max. 31 characters, \ / : * ? " < > | _ # % are not allowed).

Longitude: Longitude of the location, decimal, orientation to east positive, example Berlin: 13.40833 (corresponds to 13° 24' 30" E).

MaxCrossTalkChars: The number of characters the CHM 15k will ignore within the time interval "TimeOutRS485(s)" if not ended with <EOT> (04 HEX), <CR> (0D HEX), <LF> (0A HEX).
The parameter is included to prevent the ceilometer to fall back in its standard baud rate caused by noise on unstable communication lines.

Parameters: Queries the complete parameter list for RS485.

RS485Number: Designates the identification number in a RS485 bus system that is required to select a specific device via a data interface. In addition to the specific address, each CHM device responds to the universal identification number 99.

Standby: Switches off laser, heater and fan.

SystemStatusMode: Defines the status code variant to be used in the data telegrams. 0 = previous status codes used by CHM 15k before firmware 1.x, 1 = escalating status codes, see 8.5 Status code.

TimeOutRS485(s): Sets a time interval for MaxCrossTalkChars and BaudAfterError (default 30 s).

Time Zone offset hours: Must be set to correct for local nighttime, e.g. to switch off the fans at night. The system itself operates in UTC time.

TransferMode: See 8.3.1 Polling mode to 8.3.5 Raw data telegram.

Unit(m/ft): Specifies the target units in meters (m) or feet (ft).

UseAltitude: Inclusion of Altitude(m) in the data output. For example, an entry of 60 m for the altitude increases the transmitted cloud base height by 60 m if UseAltitude is set to 1 (true).

Zenith: Specifies the vertical angle in degrees, the Sky Condition Algorithm (SCA) uses this angle to calculate the actual height of the cloud base.

8.2 Device configuration with RS485

The user can change settings via the RS485 interface:

- for controlling the measuring processes
- for configuring the communication interfaces

8.2.1 Reading out a parameter

Querying a parameter takes place via the command:

get<SPACE><RS485Number>:<ParameterName><CR><LF>

If <ParameterName> contains a valid name according to Table 4 or Table 5, the value is delivered via

<STX>get<SPACE><Device>:<ParameterName>=<Value>;<ASCIITwo'sComplement><CR><LF><EOT>

Example with the default RS485Number = 16 and the device name = CHM060003

The short command

get 16: DVN<CR><LF>

can be used to query the device name and receive a response, here:

<STX>get 16:DeviceName=CHM060003;3F<CR><LF><EOT>

Each of the non-printable characters <STX>, <CR>, <LF> and <EOT> stand for one byte with hexadecimal codes 02, 0D, 0A and 04. The characters 3F represents the checksum of the two's complement formed over the whole response line, excluding these two characters (3F) in accordance with the protocol response formats (see sections 8.3.3 to 8.3.5).

8.2.2 Setting a parameter

A configuration parameter is changed via the command

set<SPACE><RS485Number>:<ParameterName>=<Value><CR><LF>

A successful change is confirmed with

<STX>set<SPACE><RS485Number>:<ParameterName>=<Value*>;<ASCIITwo'sComplement><CR><LF><EOT>

If <value> in the query command is within the limits of the permissible value range, the newly set value <value*> also corresponds to this parameter. If the values are too small (too large), the minimum (maximum) of the permissible range is used. Alphanumeric values <value> that exceed the maximum length of the parameter are truncated.

Examples with RS485Number = 16:

With the command

set 16:Unit(m/ft)=ft<CR><LF>

or in the short form

set 16:UNT=ft<CR><LF>

the value of all range dependent parameters in the protocol responses is changed from the default unit meters (m) to feet (ft). Since Unit(m/ft) belongs to the changeable parameters, it will be confirmed with:

<STX>set 16:Unit(m/ft)=ft;2A<CR><LF><EOT>

The value 2A is the checksum of the response line.

Example for an alphanumeric value that exceeds the parameter length and is truncated:

For the parameter "location" a 37 character long value is entered. Only the first 31 characters will be used by the system:

set 16:Location=123456789-123456789-123456789-1234567<CR><LF>

System response:

<STX>set 16:Location=123456789-123456789-123456789-1;CD<STX>

8.2.3 Changing the baud rate

The option to change the baud rate is a specific feature. The change takes place as described in 8.2.2 Setting a parameter. Thus, baud rate no. 4 that corresponds to 19,200 bits/s is set with

set<SPACE><RNO>:Baud=4<CR><LF>

The correlation between baud rate #. and baud rate is shown in Table 6.

Baud rate #	Baud rate [bit/s]
(0)	(1,200)
(1)	(2,400)
2	4,800
3	9,600
4	19,200
5	38,400
6	57,600
7	115,200

Table 7 Correlation between baud rate # and baud rate.

Baud rates 0 and 1 are not specified within the time limit. After sending a set command, the interface is immediately set to the new baud rate. An incorrectly set baud rate will lead to transmission errors afterwards and would make a normal reset impossible because of the lack of communication capability. After expiry of the time interval specified in **TimeOutRS485** (default value: 30 s), the incorrect baud rate is reset to the baud rate defined in the parameter **BaudAfterError**. This guarantees that the user can regain control of the device after this waiting period. The default value of **BaudAfterError** is 3, which corresponds to 9,600 bits / second. The default value should be modified by the user, too, in case a baud rate of e.g. 19,200 is always used.

8.2.4 Restarting the embedded system / resetting to factory settings

The command

set<SPACE><RS485Number>:Reset=1<CR><LF>

instructs the CHM 15k to perform an immediate restart. This restart takes less than one minute. Communication with the CHM 15k is not possible during this time; any current automatic telegram output is also interrupted.

The command

```
set<SPACE><RS485Number>:ResetSettings=1<CR><LF>
```

resets all parameters to the factory settings.

The command RSN restarts the network. A restart is always necessary if the network settings, e. g. IP address, DHCP mode, etc., have been changed. The new network settings are only used after entering the commands RSN or RST.

```
set<SPACE><RS485Number>:RSN=1<CR><LF>
```

8.2.5 Changing time settings

```
set<SPACE><RS485Number>:dts=30<CR><LF>
```

The logging and reporting time are set to 30 seconds. The internal measuring time is always set to one second. The login and reporting time must be a multiple of one second.

The command

```
set<SPACE><RS485Number>:DateTime=DD.MM.YYYY;hh:mm:ss<CR><LF>
```

is used to change the date and time of the embedded system.

Here, DD = day, MM = month and YYYY = year, hh = hour, mm = minute and ss = second according to time zone GMT (Greenwich Mean Time).

Example with RS485Number = 16:

```
set 16:DateTime=13.04.2006;17:22:46<CR><LF>
```

sets the date to 13.04.2006 and the time to 17:22:46 GMT.

8.3 Data query RS485

When running, the CHM 15k operates in one of the transfer modes shown in Table 7.

Transfer mode	Meaning
0	Data telegrams are only output on a specific request (polling mode)
1	Automatic output of the standard data telegram
2	Automatic output of the extended data telegram
3	Automatic output of the raw data telegram
4 ... 9	Automatic output of further predefined data telegrams

Table 8 Summary of transfer modes.

The transfer mode can be changed with the set command

```
set<SPACE><RS485Number>:TMO=<Transfermode>
```

as described in section 8.2.2 "Setting a parameter" or via direct input in the web interface.

Thus, with the command

```
set<SPACE>16:TransferMode=1<CR><LF>
```

the automatic output of the standard data telegram is activated for the device with RS485 number 16 (default setting valid at the time of delivery).

8.3.1 Polling mode

The command

```
set<SPACE><RS485Number>:TransferMode=0<CR><LF>
```

sets the polling mode and thereby any previously running automatic telegram output is issued. Entering one of these 3 polling commands causes the measurement data to be queried once from the device.

get<SPACE><RS485Number>:S<CR><LF>

get<SPACE><RS485Number>:L<CR><LF>

get<SPACE><RS485Number>:A<CR><LF>

- the standard data telegram (S), extended data telegram (L) or raw data telegram (A). For the format of the respective data telegram, see 8.3.3 *Standard data telegram* to 8.3.5 (Table 8, Table 9, Table 12).



Additional telegrams

The Nimbus hardware platform of the CHM 15k (starting in 2011) supports further user telegrams.

In addition to the characters {S, L, A}, numbers are also supported. With S = 1, L = 2, A = 3, the first three numbers are predefined.

8.3.2 Automatic output mode

With the command

set<SPACE><RS485Number>:TransferMode=1<CR><LF>

the automatic mode is set with a standard telegram output. Its repetition rate depends of variable dt(s) that is set to 15 seconds by default. Table 8 contains the format of the standard data telegram.

The output of the extended data telegram is set with the command

set<SPACE><RS485Number>:TransferMode=2<CR><LF>

Table 9 contains the format of the extended data telegram.

The raw data telegram is output via the following command:

set<SPACE><RS485Number>:TransferMode=3<CR><LF>

Table 12 contains the format of the raw data telegram.



Transfer modes 4 ... 9

The transfer modes 4 ... 9 are additional predefined data telegrams.

8.3.3 Standard data telegram

The standard data telegram consists of 96 bytes. The data is separated by spaces (20 HEX). Table 8 shows the exact structure of the message format string.

Byte	Value	Description
0	<STX>	02 HEX
1	X	
2	1	
3, 4	TA	
5	<SPACE>	20 HEX
6	8	
7	<SPACE>	20 HEX
8-10	***	Output interval [s]
11	<SPACE>	20 HEX
12-19	** ** *	Date (DD.MM.YY)
20	<SPACE>	20 HEX
21-25	** **	Time (hh:mm)
26	<SPACE>	20 HEX

Byte	Value	Description
27-31	*****	Cloud base layer 1, see section 9.3
32	<SPACE>	20 HEX
33-37	*****	Cloud base layer 2
38	<SPACE>	20 HEX
39-43	*****	Cloud base layer 3
44	<SPACE>	20 HEX
45-48	****	Penetration depth in cloud layer 1, see section 9.4
49	<SPACE>	20 HEX
50-53	****	Penetration depth of the laser beam in cloud layer 2
54	<SPACE>	20 HEX
55-58	****	Penetration depth of the laser beam in cloud layer 3
59	<SPACE>	20 HEX
60-64	*****	Vertical visibility, see section 9.7
65	<SPACE>	20 HEX
66-70	*****	Maximum detection range, see section 9.6
71	<SPACE>	20 HEX
72-75	****	Cloud height offset (zero or altitude, depending on usealtitude)
76	<SPACE>	20 HEX
77, 78	**	Unit (ft/m), ft or m<SPACE>
79	<SPACE>	20 HEX
80, 81	**	Sky condition index, see section 9.11
82	<SPACE>	20 HEX
83-90	*****	System status: 32 Bit status code; see section 8.5
91	<SPACE>	20 HEX
92, 93	**	Checksum (two's complement of the sum of bytes 0 to 96 expressed in hex code, excluding bytes 92 and 93)
94	<CR>	0D HEX
95	<LF>	0A HEX
96	<EOT>	04 HEX

Table 9 Standard data telegram format, * can be any desired character.

Up to three cloud bases are stated in the standard telegram. If less than three cloud bases are detected, the message **NODET** appears in the remaining fields. If cloud penetration depths are not determined, the message **NODT** appears in the corresponding fields.

A **NODET** value is also entered in the fields if the algorithm is unable to calculate the following values:

- Visibility (vertical visual range)
- Maximum detection range

Measured values that are exceeding the given field length, for example "12345" for a four-digit field, the field is filled with "?". With the exception of the cloud penetration depth values, these are displayed as "9999" if they exceed the length.

If the values cannot be determined due to a device error, these fields are filled with a minus sign "-" or slash "/" (see section 8.4.5 "Substitute values for target variables"). Detailed information on the type of device error can be found in the status codes (see 8.5 Status code).



Correction of the measured cloud base

The cloud height is usually determined from the bottom of the device. With the parameter "usealtitude" you can control whether the cloud heights are corrected by the value specified in the parameter "altitude(m)". If "usealtitude" is set to 1, an absolute altitude axis is used instead of the relative altitude axis. The used correction value

(zero or “altitude(m)”) is called “Cloud Height Offset”. It is included in telegrams 1 to 5 and in the NetCDF data in the variable CHO.

8.3.4 Extended data telegram

The extended data telegram consists of 240 Bytes, when the default number for layer size of 3 is selected, see Table 9. The number of cloud layers is specified in the parameter “Layer (NoL)”, see Table 4. In the extended data telegram a semicolon (3B HEX) is used as the separator instead of the space (20 HEX).

Byte	Value	Description
0	<STX>	02 HEX
1	X	
2	1	
3, 4	TA	
5	;	3B HEX
6	8	
7	;	3B HEX
8-10	***	Output interval [s]
11	;	3B HEX
12-19	** ** *	Date (DD.MM.YY)
20	;	3B HEX
21-28	***.***	Time (hh:mm:ss)
29	;	3B HEX
30	*	Number of layers
31	;	3B HEX
32-36	*****	Cloud layer 1 (CBH)
37	;	3B HEX
38-42	*****	Cloud layer 2 (CBH)
43	;	3B HEX
44-48	*****	Cloud layer 3 (CBH)
49	;	3B HEX
50-54	*****	Penetration depth of the laser beam in cloud layer 1 (CPD), NOTE: Extended to 5 digits
55	;	3B HEX
56-60	*****	Penetration depth of the laser beam in cloud layer 2 (CPD), NOTE: Extended to 5 digits
61	;	3B HEX
62-66	*****	Penetration depth of the laser beam in cloud layer 3 (CPD), NOTE: Extended to 5 digits
67	;	3B HEX
68-72	*****	Vertical visibility (VOR)
73	;	3B HEX
74-78	*****	Maximum detection range (MXD)
79	;	3B HEX
80-83	****	Cloud Height Offset (CHO)
84	;	3B HEX
85-86	**	Unit in m or ft
87	;	3B HEX
88-89	**	Precipitation index / Sky Condition Index (SCI)

Byte	Value	Description
90	;	3B HEX
91-98	*****	System status: 32 Bit status code; see 8.5 Status code
99	;	3B HEX
100-101	**	RS485 identification number CHM 15k in the RS485 bus system, error is 16
102	;	3B HEX
103-111	CHMYYnnnn	Device name (YY for year, nnnn for serial number)
112	;	3B HEX
113-117	*****	Standard deviation cloud layer 1 (CBE)
118	;	3B HEX
119-123	*****	Standard deviation cloud layer 2 (CBE)
124	;	3B HEX
125-129	*****	Standard deviation cloud layer 3 (CBE)
130	;	3B HEX
131-134	****	Standard deviation penetration depth of laser beam in cloud layer 1 (CDE)
135	;	3B HEX
136-139	****	Standard deviation penetration depth of laser beam in cloud layer 2 (CDE)
140	;	3B HEX
141-144	****	Standard deviation penetration depth of laser beam in cloud layer 3 (CDE)
145	;	3B HEX
146-150	*****	Standard deviation vertical visibility (VOE)
151	;	3B HEX
152-155	****	Software version FPGA
156	;	3B HEX
157-160	****	Software version for signal processing OMAP
161	;	3B HEX
162-163	**	System status: "OK" or "ER"
164	;	3B HEX
165-168	****	Outside temperature (Kelvin x 10)
169	;	3B HEX
170-173	****	Inside temperature (Kelvin x 10)
174	;	3B HEX
175-178	****	Detector temperature (Kelvin x 10)
179	;	3B HEX
180-183	****	Detector control voltage (Volts x 10)
184	;	3B HEX
185-188	****	Test pulse height
189	;	3B HEX
190-195	*****	Laser operating hours (h)
196	;	3B HEX
197-199	***	Window contamination status (state_optics)
200	;	3B HEX
201-205	*****	Laser frequency (PRF) (5 digits)
206	;	3B HEX
207-209	***	Receiver status

Byte	Value	Description
210	;	3B HEX
211-213	***	Laser status
214	;	3B HEX
215-219	*****	Aerosol layer 1
220	;	3B HEX
221-225	*****	Aerosol layer 2
226	;	3B HEX
227	*	Quality index aerosol layer 1
228	;	3B HEX
229	*	Quality index aerosol layer 2
230	;	3B HEX
231	*	BCC; Base Cloud Cover
232	;	3B HEX
233	*	TCC; Total Cloud Cover
234	;	3B HEX
235-236	**	Checksum (two's complement of the sum of bytes 0 to 239 expressed in hex code, excluding bytes 235 and 236)
237	<CR>	0D HEX
238	<LF>	0A HEX
239	<EOT>	04 HEX

Table 10 Extended data telegram format (see also Table 10); * = character.

For the stated standard deviations of the individual quantities, the same exception values apply as for the corresponding basic quantities (see 8.3.3 and 8.4.5): "NODET/NODT/---", "?" resp. "9999" in case of over-length of the deviation of the penetration depth.



Additional system parameters

The system parameters for data evaluation, including the penetration depth, are explained in section 9 Data Evaluation / Sky Condition Algorithm (SCA).

Designation	Description
Outside temperature	The outer temperature is measured at the bottom of the unit. Display in Kelvin x10, tolerance ± 5 K
Inside temperature	Measured temperature at the sensor: Display in Kelvin x10, tolerance ± 2 K
Detector temperature	Measured temperature at the sensor: Display in Kelvin x10, tolerance ± 2 K
NN1	unassigned
NN2	unassigned
Laser operating hours (h)	Operating time of the laser in hours
Window status	Degree of contamination of the glass window in percent 100 = clear view, 0 = opaque
Laser frequency	Number of laser pulses in the measuring interval (7-digit)

Receiver status	Evaluation of the status of the optical path and receiver 100 = maximum sensitivity 0 = no sensitivity
Laser status	Evaluation of the stability and ageing process of the laser 100 = start value (good), 0 = bad

Table 11 Designations in the extended data telegram.

8.3.5 Raw data telegram

The raw data is output in NetCDF format (for a description see 8.4 Structure of the NetCDF format). NetCDF is a binary format. For transmission via RS485 / RS232, a transformation in a 7-bit ASCII code (range 21 to 60 HEX) with UUencode is required to be able to handle none printable characters such as <STX> or <EOT>.

The size of the NetCDF file of a raw data set is approximately 14 kilobytes. The UUencode conversion produces 20 kilobytes of ASCII data that has to be transferred. At a baud rate of 9,600, the transmission takes about 16 seconds. The automatic output of the raw data telegram is restricted to specific logging time / Baud rate combinations, as set out in Table 11 below.

Baud rate no.	Baud rate [bit/s]	Logging time interval [dt(s)]
0	1,200	Not possible
1	2,400	Not possible
2	4,800	≥ 40 s
3	9,600	≥ 20 s
4	19,200	≥ 10 s
5	38,400	≥ 5 s
6	57,600	No further restrictions
7	115,200	No further restrictions

Table 12 Baud rate – logging time restrictions.

Table 13 describes the structure of the additional data of the raw data telegram.

Byte	Value	Description
0-238		Exactly as in the extended data telegram (for 3 cloud layers)
239	<CR>	0D HEX
240	<LF>	0A HEX
241-(eeee-5)		Raw data in ASCII format (UUencode)
eeee-4 eeee-3	**	Checksum (two's complement of the sum of bytes 0 to eeee, excluding bytes eeee-4 and eeee-3, expressed in Hex code)
eeee-2	<CR>	0D HEX
eeee-1	<LF>	0A HEX
eeee	<EOT>	04 HEX

Table 13 Raw data telegram format; * = any desired character.

The lines with the raw data have the following structure according to UUencode standard:

```
Line 1:
begin 644 YYYYMMDDhhmmss_[Location]_[Device ID].nc<CR><LF>
Line 2:
M*****<CR><LF>
Line 3:
M*****<CR><LF>
```

```

...
Line (n-2):
M*****<CR><LF>
Line (n-1):
E***** **<CR><LF>
Line n:
end<CR><LF>

```

The * character indicates a UUencode ASCII character in the range HEX 21-60.

The "M" (HEX 4D) at the beginning of the data lines stands for the likewise UUencoded number of data bytes in this line:

- 4D decoded corresponds to the number HEX 2D = 45 decimal.

According to 4/3 UUencode conversion, these 45 bytes are encoded into 60 ($60 = 45/3 \times 4$) ASCII characters, which follow "M". The last line is an exception, as the last bytes, which are generally less than 45, are encoded.

The above example shows "E" (HEX 45, decoded HEX 25 = 37 decimal), hence a further 37 bytes of raw data follow. As a result of the 4/3-encoding, however, this becomes 52 ASCII characters (rounded up to a multiple of 4 characters) ($52 = (37/3 \text{ rounded}) \times 4$).

The last line with "end" marks the completion of the UUencode data.

Example for the file name in Line 1:

YYYYMMDDhhmmss_ [Location]_[DeviceID].nc

e. g. 20060331123730_Berlin_CHM060003.nc (see also 8.4.3)

This means:

- Device CHM060003 in Berlin, data for 31.03.2006, 12:37:30.

8.3.6 Additional data telegrams

The structure of the data telegrams is defined in a file "telegram.xml". This file can be downloaded in super user mode from the web interface. The file can be modified and uploaded again. It can be modified and uploaded again. Please pay attention to the note on page 57 in the section 8.7.3

Different user telegrams are already pre-defined in the firmware:

- Telegram 4: Telegram 2 + fan and heating status + 8 comment fields (CM1 to CM7). The length of the telegram is variable, because the comment fields only take up the space that their length requires.
- Telegram 5: Telegram 1 + fan and heating status
- Telegram 6: CL31 data telegram 1 from Vaisala
- Telegram 7: CL31 data telegram 2 from Vaisala
- Telegram 8: CT25k data telegram 1 from Vaisala
- Telegram 9: CT25k data telegram 6 from Vaisala

A separate description is available for the predefined user telegrams. These telegrams can change.

8.4 Structure of the NetCDF format

8.4.1 General

The ceilometer saves all measured backscatter profiles in a day file in the NetCDF format (Network Common Data File). The storage capacity of the internal 8 GB SD card allows files to be kept on record for approximately one year. The files can be accessed via web interface (LAN connection). In a "Communication interrupted" service case, affected data can be inspected and traced back. In addition, the raw data of a single measurement can be called up as a raw data telegram via the RS485 or LAN interface. The operation does not include the transmission of more than a single measurement via RS485, since this would negatively influence the time sequencing in this mode. Because the transmission rate depends on the time resolution of the measured data and the RS485 interface settings, this transmission would take too long. A one-day NetCDF file with $dt(s)=30s$ measurement time intervals will be approximately 12 MB in size. Switching to 15s time resolution 24 MB daily file sizes are generated. For the LAN interface a direct access to the daily files, to 5 min files (AFD (ftp) mode) and single files via request is possible.

8.4.2 Basic principles

NetCDF provides a computer platform-independent interface for storing and reading scientific data. It was developed by Unidata, a project funded by the National Science Foundation (<http://www.unidata.ucar.edu>). Each record contains explanations of the stored content.

The ceilometer stores all the data for one day in a file and in case the AFD mode is switched on in 5 min files. The time used is UTC. In the standard mode (RS485), the CHM 15k transmits a raw data telegram with a single backscatter profile and all descriptive variables and attributes in the NetCDF format. The raw data telegrams for one day can be merged into a day file.

8.4.3 File names

Day file:	YYYYMMDD_[Location]_[DeviceID]_[Index].nc
Raw data in RS485 telegram:	YYYYMMDDhhmmss_[Location]_[DeviceID].nc
Raw data with 5-minute time resolution for AFD mode (ftp)	YYYYMMDD_[Location]_[DeviceID]_hhmm_Index.nc



Length of data file names

For problem-free file transfer, the ISO standards should be complied with in their extended form. The file length should not exceed 31 characters. For the structure of the day files with [Date]_[Location]_[DeviceID]_[Index].nc (8_5_9_3.2=31 characters), this means that the variable "location" has less than 5 characters.

8.4.4 Format structure

With firmware version 1.050 a new NetCDF format was introduced, which stores the backscatter signal as attenuated backscatter (beta_att). For compatibility reasons, the NetCDF format is still available with the normalized, range-corrected backscatter signal (beta_raw). To switch between the two formats, there is the parameter NetcdfMode, which can be used as usual via the web interface or via RS485 access, see sections 8.1, 8.2, and 8.7.3. If NetcdfMode is set to 1, the measurement data is stored in the new beta_att format and for NetcdfMode 2 the older beta_raw format is used.

In NetCDF format the values to be stored are defined and stored by dimensions, variables and attributes. The format of dimensions and global attributes is the same for both NetCDF formats, see Table 13 and Table 14. The attribute netcdf_mode identifies the NetCDF format used according to the NetcdfMode. Table 15 describes the variables used for the beta_att format and Table 16 for the beta_raw format.

Dimensions

Dimension	Description	Default
time	Number of measured backscatter profiles within a NetCDF file	UNLIMITED
range	Number of values in measuring range stored in backscatter profiles in the NetCDF format with a resolution of 5 ... 30 m depending on the setting, default 15 m.	1024
range_hr	Number of values stored in the high-resolution NetCDF backscatter profile with a resolution of 5 m	32
layer	Number of cloud layers transmitted in telegrams and stored in NetCDF files	3

Table 14 Dimensions in NetCDF.

Global attributes

Attribute	Description	Type
Title	Heading for graphical representation, here "Lufft Berlin, CHM 15"	text
source	see device_name (left for compatibility reasons)	text
device_name	Serial number, device name of the instrument, e. g. CHM090104	text
serlom	Serial number of laser optical unit, e. g. TUB080022	text
Day	day of a month, on which the data was recorded	int
month	Month as a number, January = 1, ...	int
year	year, in which the data were recorded: e. g. 2019	int
location*	Location / site of measurement	text
institution*	Institution or company	text
wmo_id*	WMO station ID	int
wigos_id*	WIGOS station identifier	text
netcdf_mode	Identification of the NetCDF format (1 .. beta_att, 2 .. beta_raw)	int
software_version	Operating system, FPGA, firmware, CloudDetectionMode	text
comment*	Any descriptive comment	text
overlap_file	Name / time of the overlap correction function used to generate the beta variables	text

Table 15 Global attributes in NetCDF; * User-defined settings

Variables for beta_att format

Variable	Type	Dim.	Attribute		
			Unit	Long description	Scaling
time	double	time	seconds since 1904-01-01 00:00:00.000 00:00	End time of measurement (UTC)*	
range	float	range	m	Distance from device (independent of direction and height of installation site)*	
range_hr	float	range_hr	m	Distance from device for high-resolution data*	
layer	int	layer		Index of layers	
latitude	float		degrees_north	Latitude of installation site	
longitude	float		degree	Longitude of installation site	
azimuth	float		degree	Azimuth angle of device (laser direction)	
zenith	float		degree	Zenith angle of device (laser direction)	

Variables for beta_att format

Variable	Type	Dim.	Attribute		
			Unit	Long description	Scaling
altitude	float		m	Altitude of ceilometer above mean sea level	
wavelength	float		nm	Laser wavelength in nm	
average_time	int		ms	Averaging time per record	
range_gate	float		m	Range resolution of data	
range_gate_hr	float		m	Range resolution of high-resolution data	
life_time	int	time	h	Laser operating hours	
error_ext	int	time		32-bit status code	
state_laser	byte	time	percent	Laser quality index	
state_detector	byte	time	percent	Quality of detector signal	
state_optics	byte	time	percent	Optical quality index	
temp_int	short	time	K	Internal temperature	0.1
temp_ext	short	time	K	External temperature	0.1
temp_det	short	time	K	Detector temperature	0.1
temp_lom	short	time	K	Temperature of laser optic module	0.1
laser_pulses	int	time		Number of laser pulses averaged per record (lp)	
p_cal	short	time	counts	Calibration pulse (for normalization of detection sensitivity over time) in photons per shot	0.00001
c_cal	float			Calibration constant (c)	
scaling	float			Scaling factor (cs)	
base	float	time	counts	Baseline height of raw signal (mainly influenced by background light) (b)	
stddev	float	time	counts	Standard deviation raw signal in photons per shot	
beta_att	float	time range	1/m * 1/sr	Attenuated backscatter signal $((P_{raw} / lp) - b) / (cs * o(r) * p_{calc}) * r * r * c$, with $P_{raw} = \sum(P_{raw_hr}) * range_gate_hr / range_gate$	
beta_att_hr	float	time range_hr	1/m * 1/sr	Attenuated backscatter signal (high resolution) $((P_{raw_hr} / lp) - b) / (cs * o(r) * p_{calc}) * r * r * c$	
pbl	short	time layer	m	Aerosol layers	

Variables for beta_att format

Variable	Type	Dim.	Attribute		
			Unit	Long description	Scaling
pbs	byte	time layer		Quality score for aerosol layers (1: good, ..., 9: bad)	
tcc	byte	time		Total cloud cover	
bcc	byte	time		Base cloud cover	
sci	byte	time		Sky condition index (0: nothing, 1: rain, 2: fog, 3: snow, 4: precipitation or particles on window)	
vor	short	time	m	Vertical optical range	
voe	short	time	m	Vertical optical range error	
mxd	short	time	m	Maximum detection height	
cbh	short	time layer	m	Cloud base height	
cbe	short	time layer	m	Cloud base height variation	
cdp	short	time layer	m	Cloud depth	
cde	short	time layer	m	Cloud depth variation	
cho	short		m	Cloud height offset	
nn1	short	time		nn1	
nn4	short	time		nn3	

Table 16 Variables in the NetCDF file for the beta_att format.
 *time: corresponds to the end time of each measurement period (average_time)
 range: corresponds to the start of each distance interval (range_gate, range_gate_hr)

Variables for beta_raw format

Variable	Type	Dim.	Attribute		
			Unit	Long description	Scaling
Time	double	time	seconds since 1904-01-01 00:00:00.000 00:00	End time of measurement (UTC)*	
range	float	range	m	Distance from device (independent of direction and height of installation site)*	
range_hr	float	range_hr	m	Distance from device for high-resolution data*	
layer	int	layer		Index of layers	
latitude	float		degrees_north	Latitude of installation site	
longitude	float		degree	Longitude of installation site	
azimuth	float		degree	Azimuth angle of device (laser direction)	

Variables for beta_raw format

Variable	Type	Dim.	Attribute		
			Unit	Long description	Scaling
zenith	float		degree	Zenith angle of device (laser direction)	
altitude	float		m	Altitude of ceilometer above mean sea level	
wavelength	float		nm	Laser wavelength in nm	
average_time	int		ms	Averaging time per record	
range_gate	float		m	Range resolution of data	
range_gate_hr	float		m	Range resolution of high-resolution data	
life_time	int	time	h	Laser operating hours	
error_ext	int	time		32-bit status code	
state_laser	byte	time	percent	Laser quality index	
state_detector	byte	time	percent	Quality of detector signal	
state_optics	byte	time	percent	Optical quality index	
temp_int	short	time	K	Internal temperature	0.1
temp_ext	short	time	K	External temperature	0.1
temp_det	short	time	K	Detector temperature	0.1
temp_lom	short	time	K	Temperature of laser optic module	0.1
laser_pulses	int	time		Number of laser pulses averaged per record (lp)	
p_cal	short	time	counts	Calibration pulse (for normalization of detection sensitivity over time) in photons per shot	0.00001
scaling	float			Scaling factor, used to normalize LOMs (cs)	
base	float	time	counts	Baseline height of raw signal (mainly influenced by background light) (b)	
stddev	float	time	counts	Standard deviation raw signal in photons per shot	
beta_raw	float	time range		Normalized range corrected signal $\left(\frac{P_{raw}}{lp} - b \right) / (cs * o(r) * p_{calc}) * r * r$ with $P_{raw} = \text{sum}(P_{raw_hr}) * \text{range_gate_hr} / \text{range_gate}$	
beta_raw_hr	float	time range_hr		Normalized range corrected signal (high resolution) $\left(\frac{P_{raw_hr}}{lp} - b \right) / (cs * o(r) * p_{calc}) * r * r$	
pbl	short	time layer	m	Aerosol layers	

Variables for beta_raw format

Variable	Type	Dim.	Attribute		
			Unit	Long description	Scaling
pbs	byte	time layer		Quality score for aerosol layers (1: good, ..., 9: bad)	
tcc	byte	time		Total cloud cover	
bcc	byte	time		Base cloud cover	
sci	byte	time		Sky condition index (0: nothing, 1: rain, 2: fog, 3: snow, 4: precipitation or particles on window)	
vor	short	time	m	Vertical optical range	
voe	short	time	m	Vertical optical range error	
mxd	short	time	m	Maximum detection height	
cbh	short	time layer	m	Cloud base height	
cbe	short	time layer	m	Cloud base height variation	
cdp	short	time layer	m	Cloud depth	
cde	short	time layer	m	Cloud depth variation	
cho	short		m	Cloud height offset	
nn1	short	time		nn1	
nn2	short	time		nn2	
nn3	short	time		nn3	

Table 17 Variables in the NetCDF file for the beta_raw format.

*time: corresponds to the end time of each measurement period (average_time)

range: corresponds to the start of each distance interval (range_gate, range_gate_hr)

8.4.5 Substitute values for target variables

If evaluation parameters determined by evaluating the backscatter signal cannot be determined, various special values are written to the corresponding NetCDF variable depending on the cause of the non-determination. This applies to the NetCDF variables cbh, cbe, cdb, cde, mxd, pbl, pbs, bcc, tcc, vor, voe, sci and state_optics. Table 17 shows the general meaning of the special values. In deviation from this, there is only the value -2 for the variables sci and state_optics. The slightly different meaning of the special values for bcc, tcc and pbs is given in Table 22 and Table 23.

In the standard telegrams, the special values are represented by the characters specified in Table 17 Column 2. It depends on the number of digits of the target variables in the telegram, which of the respective variants is used.

Special value	telegram value	description
-1	NODET, NDET, //, /	The target variable could not be determined in the signal, for example no cloud base due to clear sky.
-2	-----, ----, --, -	There is a hardware error. No data evaluation can be performed.
-3	NODET, NDET, //, /	The sky condition algorithm was not able to determine the target variable, e.g. possible when not enough raw data are available.

Table 18 Substitute values for target variables

8.5 Status code

There are two different status code variants, each of which reflects the device status as a 32-bit number. Table 18 lists the meanings of the individual bits of the status codes, which are known from the CHM 15k. The output of these status code variants occurs in the web interface and in the NetCDF data. For the output of these data telegrams, for example in the standard telegram, characters 83 ... 90 or in the extended data telegram with the characters 91 ... 98 (refer to Table 8 and Table 9), optionally the escalate status code is available, refer to chapter 8.5.1.

The status codes will be illustrated as an eight-digit hexadecimal number. Non-set bits mean that the corresponding part is running properly. Set bits indicate errors, warnings or ongoing initializations, e. g. shortly after switching on.

Bit	Hex	Type	Error (original)
0	00000001	Error	Signal quality
1	00000002	Error	Signal recording
2	00000004	Error	Signal values null or void
3	00000008	Error	Mainboard detection failed (APD bias) or firmware and CPU do not match
4	00000010	Error	Create new NetCDF file
5	00000020	Error	Write / add to NetCDF error
6	00000040	Error	RS485 telegram cannot be generated and transmitted
7	00000080	Error	SD card absent or defective
8	00000100	Error	Detector voltage control failed or cable absent or defective
9	00000200	Warning	Inner housing temperature out of range
10	00000400	Error	Laser optical unit temperature error
11	00000800	Error	Laser trigger not detected or laser disabled (safety-related)
12	00001000	Note	NTP problem
13	00002000	Error	Laser controller
14	00004000	Error	Laser head temperature
15	00008000	Warning	Replace laser - ageing

Bit	Hex	Type	Error (original)
16	00010000	Warning	Signal quality – high noise level
17	00020000	Warning	Windows contaminated
18	00040000	Warning	Signal processing
19	00080000	Warning	Laser detector misaligned or receiver window soiled
20	00100000	Warning	File system, fsck repaired bad sectors
21	00200000	Warning	RS485 baud rate / transfer mode reset
22	00400000	Warning	AFD problem
23	00800000	Warning	Configuration problem
24	01000000	Warning	Laser optical unit temperature
25	02000000	Warning	External temperature
26	04000000	Warning	Detector temperature out of range
27	08000000	Warning	General laser issue
28	10000000	Note	Number of layers > 3 and telegram selected
29	20000000	Note	Device was started
30	40000000	Note	Standby mode on

Table 19 Status codes / status bits.

The unused bits are set to 0 by default so that the hexadecimal status code 0 indicates the full operational readiness of the CHM 15k.

8.5.1 Escalated status codes

An additional escalating status code was implemented in 2018. It is divided into the following eight groups:

1. Settings
2. Data transmission and storage
3. Temperatures
4. Data processing and calculations
5. Laser and test laser
6. Detectors
7. Other sensors (window contamination sensor, laser monitor)
8. Not available

Each group is assigned a position in the hex representation of the 32-bit status code. For example, information, warnings and errors relating to temperatures (group 3) are in the third place from the right, i.e. xxxxTxx.

In each group, only the highest priority error, the highest error code in the status code, is displayed. With the setting *SystemStatusMode (SSM)* the user can define, which status code variants for the telegram output should be used. The CHM 15k is using the standard status codes by default.

Color legend for Table 20:	
	All OK
	Information
	Warning
	Error

Group	Hex code	Error description	Duration [s]
1	Configuration		
	xxxx xxx0	Setup works correctly	
	xxxx xxx1	Restart after reboot or firmware restart (SW)	60
	xxxx xxx2	Restart after shutdown	60
	xxxx xxx3	Restart after watchdog triggered (FW)	60
	xxxx xxx4	Restart (e.g. after power failure)	60
	xxxx xxx5	Device running in standby	delete*
	xxxx xxx6	Invalid parameter, previous or corrected configuration is used	300
	xxxx xxx7	Unknown NetCDF format identifier in Settings file	60
	xxxx xxx8	Note: Number of layers too large for telegram 1	60
	xxxx xxx9	Dimensions do not match	∞
	xxxx xxxA	No valid overlap file found	∞
	xxxx xxxB	EEPROM defective / not available or cable defective	16
	xxxx xxxC	Mainboard identifier cannot be read	∞
	xxxx xxxD	Firmware does not match the CPU version	∞
2	Data transmission and storage		
	xxxx xx0x	Data transmission and storage working properly	
	xxxx xx1x	Faulty file system on SD card repaired	60
	xxxx xx2x	NTP problem	60
	xxxx xx3x	RS485 baud rate / transfer mode were reset	60
	xxxx xx4x	AFD problem	60/ 600
	xxxx xx5x	RS485 data telegram cannot be transmitted	16
	xxxx xx6x	RS485 data telegram cannot be generated	16
	xxxx xx7x	Write error in NetCDF file	60
	xxxx xx8x	New NetCDF file cannot be generated	60
	xxxx xx9x	SD card not available or defective	∞
3	Temperatures		
	xxxx x0xx	Temperature values are in range	
	xxxx x1xx	Detector temperature not in best performance range (setpoint -1 °C ... +3 °C)	60
	xxxx x3xx	Laser optical module (LOM) temperature outside the valid range (25 °C ... 49 °C)	60
	xxxx x4xx	Internal temperature outside the working range (5 °C ... 50 °C)	16
	xxxx x5xx	External temperature outside the working range (-40 °C ... 50 °C)	60

Group	Hex code	Error description	Duration [s]
	xxxx x6xx	Laser optical unit temperature control disabled due to safety reasons	16 / ∞
	xxxx x7xx	Laser controller temperature too high	60
	xxxx x8xx	Laser head temperature too high or too cold	16
	xxxx x9xx	Laser optical unit temperature too high	16
	xxxx xAxx	Laser temperature out of working range or invalid	delete*
4 Calculation / processing in sky condition algorithm			
	xxxx 0xxx	Data processing OK	
	xxxx 1xxx	Problem in calculating the visual range	16 / 60
	xxxx 2xxx	Problem in calculating of aerosol layers	60
	xxxx 3xxx	Problem in calculating of cloud coverage	60
	xxxx 4xxx	Problem in calculating of clouds	60
	xxxx 5xxx	Abnormal signal	60
	xxxx 6xxx	Incorrect dimensioning of raw data	16
	xxxx 7xxx	No new data	16
5 Laser and LED test pulse			
	xxx0 xxxx	Laser and LED test pulse working normally	
	xxx1 xxxx	General laser issue	60
	xxx2 xxxx	LED test pulse less than or equal to zero	16
	xxx3 xxxx	Replace laser (ageing)	60
	xxx4 xxxx	Error: laser controller	16
	xxx5 xxxx	Error: laser trigger not detected	16
	xxx6 xxxx	Laser disabled (laser-safety-related)	16 / ∞
6 Detector (receiver)			
	xx0x xxxx	Main detector working normally	
	xx1x xxxx	Signal quality – low reference pulse	16
	xx2x xxxx	Laser detector misaligned, or receiver window soiled	60
	xx6x xxxx	Values from detector signal zero or void	16
	xx7x xxxx	Insufficient test laser signal available	16
	xx8x xxxx	No window pulse in receiver signal	16
	xxDx xxxx	No receiver signal (detector or HV supply defect?)	16
	xxEx xxxx	No receiver signal (power supply cable?)	16
	xxFx xxxx	No receiver signal (signal cable?)	16

7	Window contamination		
	x0xx xxxx	Window not contaminated	
	X3xx xxxx	Window contaminated	60

Table 20 Escalated status codes (HW: Hardware, SW: Software, FW: Firmware), *delete: error is shown until fault condition is removed.

8.6 Firmware update

The system software of the CHM 15k can be updated via the ethernet interface (WAN / LAN connection). The software update functionality is available as super user and is provided in the tab “Config System” of the web interface. Details can be found in the following section. Since firmware 1.110 the firmware can only be updated. A downgrade functionality has been disabled as configuration files are not compatible any longer to older firmware releases.

8.7 Communication via the web interface (Ethernet)

8.7.1 Device overview and access rights (Device tab)



Figure 18 Web interface, device tab.

Figure 16 shows the start screen ("Device" tab) after successful connection with the CHM 15k (for startup see 7.2). The tab shows information about the current status of the device. Logging in as a superuser or service user is possible by entering the password in the “administration” form field.

Communication with the CHM 15k via an Ethernet connection is fast, comfortable and system-independent. An Apache web server runs inside the device. This enables a communication and configuration platform via the web interface for processing firmware updates, quick previews of measurement results or downloading full-day NetCDF raw data.

In general, the web interface contains the following access rights:

- End users can check the status of the instrument.
- Superusers can download NetCDF files, configure the device, download the user manual as well as other configuration files, update the firmware.
- Service users can modify additional system parameters for example the serial number of the device, upload critical configuration files, e.g. the telegram description and reset the super user password

The status information on the device tab and the content in the process status tab are updated every minute. The listed status information codes correspond to the status codes in Table 18 and the status provided in data telegrams via RS485 interface. The process status (Figure 24) provides additional information for the service personnel.

In superuser or service mode, the start page contains buttons to switch the device off or to initiate a reset.

8.7.2 Access to measurement data (NetCDF files, viewer)

Figure 17 shows the directory of NetCDF files that are visible to all users. In superuser or service mode, these NetCDF files can be downloaded by clicking on the file name.

Device	Viewer	NetCDF Files	Config System	Config Network	Config RS485	Process Status	?
Count: 181		Update List					
File Name		Size [kB]					
20190924_Berlin_CHM15kd01_000.nc		6369					
20190923_Berlin_CHM15kd01_000.nc		24579					

Figure 19 Web interface: NetCDF Files

Figure 18 shows the contents of the "Viewer" tab, displaying the range corrected backscatter data for the last 24 hours. Clicking the "Update" button updates the image file, however a new image is only generated every 5 minutes. The "BackscatterMax" parameter in the "Config System" tab (Figure 21) can be changed to easily adjust the color scale. The currently detected clouds are updated in the logging interval dt(s) and displayed together with aerosol layers and the cloud coverage in the table above the image data.

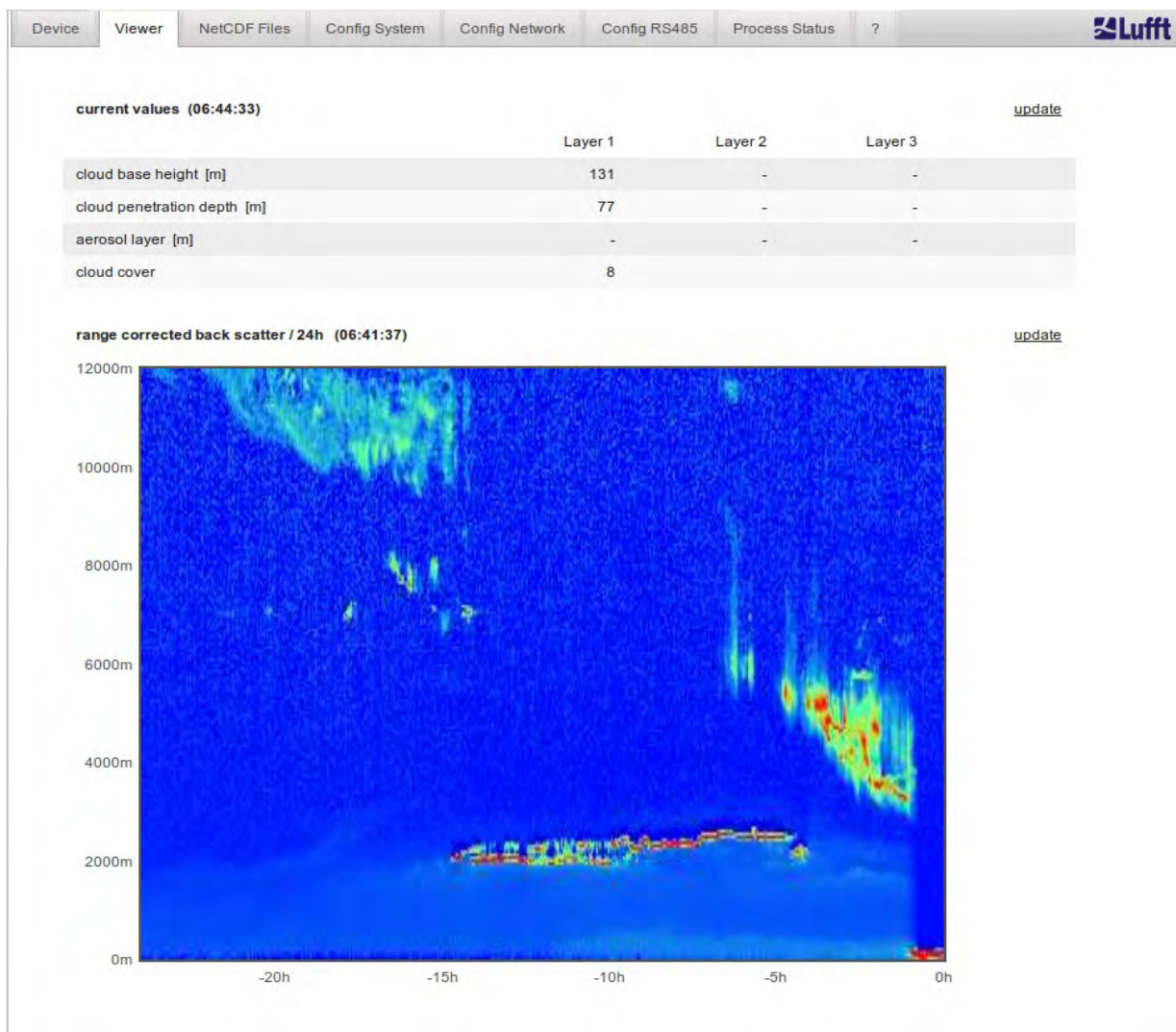

Figure 20 Web interface: Viewer.

8.7.3 Configuring the CHM 15k (Config tab)

The contents of the configuration pages ("Config System", "Config Network" and "Config RS485") are only accessible to superusers and service users. The parameters can also be set via RS485 communication and are described in section 8.1.

The screenshot shows a web interface with a navigation bar at the top containing tabs: Device, Viewer, NetCDF Files, Config System, Config Network (selected), Config RS485, Process Status, and a help icon (?). The Lufft logo is in the top right corner. Below the navigation bar, the 'Network Information' section is displayed as a table with three columns: Name, Address, and Netmask. The table lists several network-related items, including interfaces and system settings. An 'update' link is located at the bottom right of the table area.

Name	Address	Netmask
eth0:2 (dhcp)		
eth0:1 (custom)	10.130.65.120	255.255.255.0
eth0 (fix)	192.168.100.101	255.255.255.0
gateways	10.130.65.2	
ntp server	192.53.103.104	

Figure 21 Web interface: Config Network tab (read-only mode) for a device with configured static IP (eth0:1)

The screenshot displays the 'Config Network' tab in superuser mode. At the top, there is a navigation bar with tabs: Device, Viewer, NetCDF Files, Config System, Config Network (selected), Config RS485, Process Status, and a help icon. The Lufft logo is in the top right corner.

Network Information

Name	Address	Netmask
eth0:2 (dhcp)		
eth0:1 (custom)	10.130.65.120	255.255.255.0
eth0 (fix)	192.168.100.101	255.255.255.0

Below the table, there are fields for 'gateways' (10.130.65.2) and 'ntp server' (192.53.103.104), with an 'update' link.

Network Configuration

DhcpMode	0	<input type="text"/>	set
IPAddress	10.130.65.120	<input type="text"/>	set
Netmask	255.255.255.0	<input type="text"/>	set
Gateway	10.130.65.2	<input type="text"/>	set
DnsServer		<input type="text"/>	set

A 'restart network' link is located below the configuration table.

AFD Configuration

NtpMode	1	<input type="text"/>	set
NtpServer	192.53.103.104	<input type="text"/>	set
LanTelegramNumber	2	<input type="text"/>	set
LanTransferMode	1	<input type="text"/>	set
LanPort	11000	<input type="text"/>	set
HttpPort	80	<input type="text"/>	set

Below the AFD configuration, there is an 'AfdMode' field with value 1 and a 'set' link. A link 'Download AFD dir_config' is also present. At the bottom, there is an 'Upload new AFD dir_config' section with a 'Browse...' button, the text 'No file selected.', and a 'send' button.

Figure 22 Web interface: Config Network (superuser mode).

Figure 19 shows the "Config Network" tab of a device with static IP in the default user view. In the super user / service user view in the network configuration tab (Figure 20 Web interface: Config Network (superuser mode)), the static IP address (eth0: 1 custom), netmask, and gateway can be adjusted to the local network conditions. When all related settings have been confirmed and saved using the "Set" command, the network must be restarted to accept the new settings. The restart can be initiated by clicking on the "Restart network" button.

Before switching on the AFD (ftp) mode, the AFD configuration file should be carefully adjusted and installed. See section 8.8 AFD mode for further information.

Figure 21 shows the contents of the "Config System" tab, which allows adjustments of system and measurement parameters.

Parameter	current Value	new Value	
Location	DachBerlin	<input type="text"/>	set
Institution	Lufft	<input type="text"/>	set
WMOStationCode	0	<input type="text"/>	set
WIGOSStationID		<input type="text"/>	set
Comment		<input type="text"/>	set
Longitude	0	<input type="text"/>	set
Latitude	0	<input type="text"/>	set
Zenith	0	<input type="text"/>	set
Azimuth	0	<input type="text"/>	set
Altitude	0	<input type="text"/>	set
UseAltitude	0	<input type="text"/>	set
LoggingTime	15	<input type="text"/>	set
Unit	0	<input type="text"/>	set
Layer	3	<input type="text"/>	set
TimeZoneOffsetHours	0	<input type="text"/>	set
BlowerMode	0	<input type="text"/>	set
RangeResolution	3	<input type="text"/>	set
RangeStart	5	<input type="text"/>	set
RangeEnd	10000	<input type="text"/>	set
RangeHrDim	32	<input type="text"/>	set
NetcdfMode	1	<input type="text"/>	set
UAPD	210000	<input type="text"/>	set
ApdControlMode	2	<input type="text"/>	set
Standby	0	<input type="text"/>	set
CloudDetectionMode	3	<input type="text"/>	set
TestMode	0	<input type="text"/>	set
BackscatterMax	40000000	<input type="text"/>	set

Figure 23 Web interface: Config System upper part (superuser).

It is recommended to enter parameters like location, institution, longitude and latitude, as this information is helpful when data are compared with other instruments at a later stage. The information is also useful if Lufft support is required to identify issues.

To ensure correct operation of the CHM 15k, some parameters in the superuser mode are not listed here. Further down on the same page, firmware updates can be uploaded to the instrument in superuser mode (Figure 22). New firmware files are packed in zip files and must be uploaded in this form. New firmware versions are published on the Lufft website. A list of previously released versions is attached to this manual in section 11.2.



Figure 24 Web interface: Config system bottom section (superuser).

Figure 25 shows the tab “Config RS485”. In case a modified telegram format description file will be uploaded (telegramformat.xml) some important notes must be considered:

- Any firmware update will overwrite the existing telegramformat.xml.
- It is necessary to restart the firmware once the modified file has been uploaded.



Modified telegram description file

Before updating the firmware, users must save their modified description file locally. The individual „telegramformat.xml“ file must be uploaded again after the firmware update. The new description file will only take effect after a restart of the ceilometer.

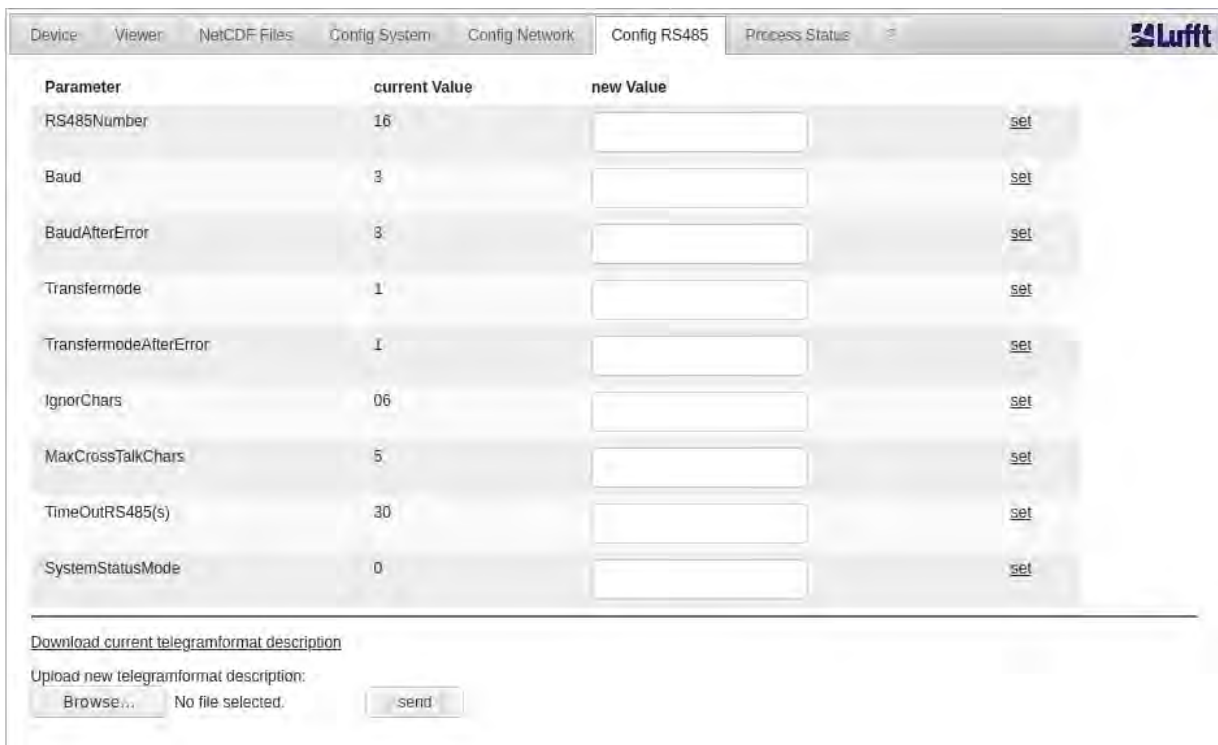

Figure 25 Web interface: RS485 configuration (superuser).

8.7.4 Status and error messages (process status)

The upper part of the Process Status tab of Figure 24 is mainly used by the Lufft service to identify problems and specific errors. If switched on, the lower section shows the status of AFD and NTP. The NTP daemon is responsible for the automatic time synchronization (see section 8.7.5) and the NTP status helps to identify the synchronization status. The information about the NTP service is only displayed and updated every minute if the NTP mode is active (= 1).

The display of the NTP status (see Figure 24) shows the information requested with the `ntpq -pn` command. The most important values are only briefly described here. Everything else can be found in the `ntpq` documentation, for example <http://doc.ntp.org/4.1.0/ntpq.htm>.

Designation	Description
NTP server	Specifies the address of the time server and its selection status. For example, a '*' means that the time server is used for system synchronization.
Reachability of the server	Provides information about the availability of the server during the last connection requests. The accessibility is binary and not octal as specified by <code>ntpq</code> . Each 1 stands for a successful connection and 0 for an unsuccessful connection.
Polling interval [s]	Specifies the interval at which the time server is queried.
Last response [s]	Specifies how many seconds ago the time server was last queried.
Status error	Contains an error code that indicates problems during NTP status generation. For example, the NTP daemon is not active or was started without an Ethernet connection. Normally a 0 is returned.

Table 21 NTP status

If the AFD mode (advanced file distribution) is activated, the status of the transferred files is displayed. The correct setup or errors encountered during configuration with the AFD configuration file can be detected too.

8.7.5 Time server

Automatic time synchronization with a time server (NTP server) is only performed if the `NtpMode` parameter is set to 1 and a valid time server (NTP server) is set. The preconfigured server is: 0.0.0.0 (no time server) and the time server mode NTP is switched off.

Example for a time server with IP address: `ptbtime1ptb.de`, IP address 192.53.103.108.

Using this IP address is recommended. Using a time server name is only possible if a valid DNS server address was set before, as the DNS server is needed to resolve the server name. If the system detects a time server, it is used immediately.

If the `Ntp` mode is activated during operation and the time difference between server and CHM 15k is greater than 1000 s, no time synchronization is performed. In this case, a firmware restart or one-time manual time setting with reactivation of the `Ntp` mode is necessary to accept the time of the time server anyway. Status information can be queried in the web interface in the "Process Status" tab.



Please note:

The user should avoid time settings via the `date-time` command (RS485) with simultaneous execution of `ntpd` over TCP / IP.

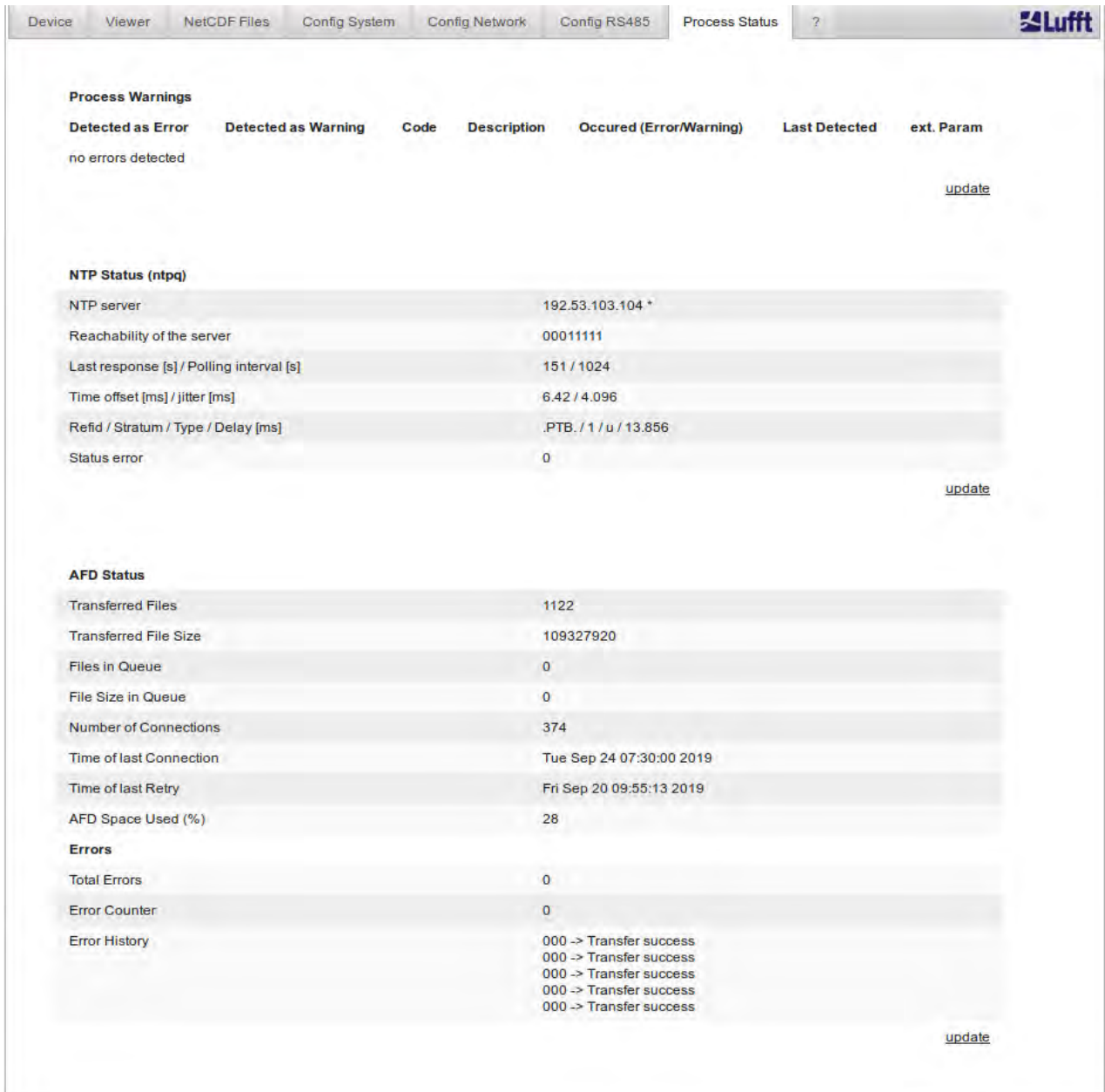

Figure 26 Web interface: Process warnings and error log. AFD and NTP status are only visible if AFD, NTP mode are set to 1.

8.8 AFD mode

A specific communication mode called automatic file distribution (AFD) mode is supported by the CHM ceilometer series. AFD is used by the CHMs to automatically send data measured in NetCDF format to an ftp server. The operation requires an active Ethernet connection.

The AFD mode can be activated via the web interface (Figure 20) in superuser mode. The configuration file “afdsettings” must be downloaded, configured, and uploaded again to accommodate local needs. AFD is preset to transfer three 5-minute NetCDF files every 15 minutes. The user can merge the NetCDF files into 24-hour files.

The configuration file “afdsettings.txt” is shown below. The official file name is: “dir_config”. Further information on the commands listed here can be found on the [DWD-AFD website](#). Hashes (#) are used to comment out commands.

Configuration file “afdsettings.txt”

```
[directory]
/tmp/afd/netcdf/afd-src

[dir options]
delete unknown files 0
delete queued files 6

[files]
*

[destination]

[recipient]
ftp://user:password@host_ip/path/%h/%tY/%tm

[options]
priority 9
create target dir
time */15 * * * *
lock DOT
age-limit 3600
# exec -d bzip2 %s
```

**When editing the configuration file:**

The full format (blank lines and indentation depth) of the AFD settings file is important. If the sample file is downloaded from the ceilometer, carefully replace each item step by step. “#” is used to leave a comment instead of a statement.

Example for a “afdsetting.txt” file with:

- Ftp server 192.168.1.51
- Subdirectory from root on server: /home/chm_data
- user name: afd
- password: eXample

“... ”

```
[recipient]
ftp://afd:eXample@192.168.1.51//home/chm_data/%h/%tY/%tm

[options]
priority 9
create target dir
time */15 * * * *
lock DOT
age-limit 3600
exec -d bzip2 %s
```

“

Every 15 minutes, bzip-compressed files are transferred to the ftp server in a directory specified by /home/chm_data/hostname/year/month. Hostname “%h” is the device name, e.g. CHM060001, year “%tY” and month “%tm” are the time settings specified by the device.

A double-slash // after the IP address indicates that the path starts in the source directory; a single slash / indicates that the path starts from the ftp-home directory.

An ftp path in the Windows directory may look like this:

```
ftp://afd:eXample@162.168.1.51/%h/%tY/%tm.
```

The file is stored in the subdirectory /%h/%tY/%tm of the main directory on the ftp server.

The command “time * * * * *” sends a 5-minute NetCDF file immediately after it is created.

8.9 Telegram via Ethernet

In addition to the RS485 interface, it is also possible to receive data telegrams via the Ethernet interface. There are two different transmission modes. The telegrams can be interrogated individually (polling mode) or sent automatically by the Ceilometer.

For the configuration of the behavior of the telegram output via Ethernet the parameter „LanPort“, „LanTelegramNumber“ and „LanTransferMode“ are available. These parameters can be set via RS485 or in the register “Config Network” of the web interface, refer to Table 4.

All user data telegrams described in section 8.3 *Data query RS485* can be called up. The raw data telegram is still uuencoded as in RS485 transmission mode and must be uudecoded before it can be read.

The Ceilometer (server) waits on the "LanPort" port until an external (client) connection request is received. Only then it can send telegrams to the client. Such a request can be executed for example with ncat or telnet. A request of a client to a CHM with the IP 192.168.100.101 and a LanPort of 11000 can look like this:

```
ncat 192.168.100.101 11000
    or
telnet 192.168.100.101 11000
```

On Windows operating systems, binary net tool files can be downloaded and installed from the server <https://nmap.org/download.html>. This website also provides binary and source codes for other operating systems.

After a connection request from the client, in the **polling mode** just a single telegram (in the “LanTelegramNumber” specified format) will be send and then the connection from the CHM finished. In the **automatic transfer mode**, the CHM is sending continuously (in the logging interval) telegrams to all connected clients.

8.10 NetCDF file tools

Several tools are available for processing, modifying, or merging NetCDF files. In particular, when used in AFD mode the ncrca.exe program is very powerful for merging files, in order to create 24-hour files from individual 5-minute files.

The same command can also be used to merge individual NetCDF files from raw data telegrams into day files.

ncrca is part of the nco tool set and can be downloaded from the following website:

<http://nco.sourceforge.net>

For users of the Windows operating system:

The direct application of the command ncrca.exe in the Windows command line is restricted by the use of wildcards and the total length of the command line. We recommend using git-bash, for example, to circumvent this problem.

Example:

The following command line allows the merging of all NetCDF files that are located in the data directory of device CHM123456 for April 6, 2015. The output file of the example is out.nc.

```
ncrca.exe -Y ncrca -h data/20150406_Berlin_CHM123456*.nc out.nc
```

9 Data Evaluation / Sky Condition Algorithm (SCA)

The CHM 15k ceilometer is a laser remote sensing device with embedded algorithm for determining layers of particles and droplets in the atmosphere. The embedded algorithm is collectively referred to as the Sky Condition Algorithm (SCA). Ceilometers determine the cloud base and provide information on the penetration depth into cloud. In case another cloud or aerosol layer can be measured above the lower cloud the penetration depth can be interpreted as cloud thickness. In addition, the degree of cloud coverage is determined in terms of eighths of the sky. For visibilities below 2 km the vertical visibility (VOR) is calculated and output in addition. An aerosol algorithm based on a wavelet algorithm detects different aerosol layers and transmits those detected within the atmospheric boundary layer. Fog / haze and precipitation are detected and transmitted in the Sky Condition Index (SCI) parameter.

9.1 Laser remote sensing

A pulsed near infrared laser probes the sky vertically from top of the instrument up to 15 km altitude. Targets like aerosol layers and clouds show up as echoes with certain backscatter intensity and signal extinction. Molecular absorption as well as Rayleigh scattering by air molecules is negligible at a laser wavelength of 1064 nm. The distance of the scattering particles to the instrument is calculated from the travelling time of the laser pulses.

9.2 Preparation of the measured data

Data pre-processing is an important task before the different steps in the SCA algorithm begin. The main reason for this is to harmonize / normalize the data sets between different CHM 15k systems to get similar results, e. g. for cloud bases, even if the sensitivity between instruments varies.

Each single measurement is normalized by determining the detection sensitivity with a reference light pulse p_{calc} . Differences between different devices are compensated by a scaling factor c_s , which is determined by a comparison measurement with a reference device. Figure 25 shows the profiles of two different devices after normalization and calibration.

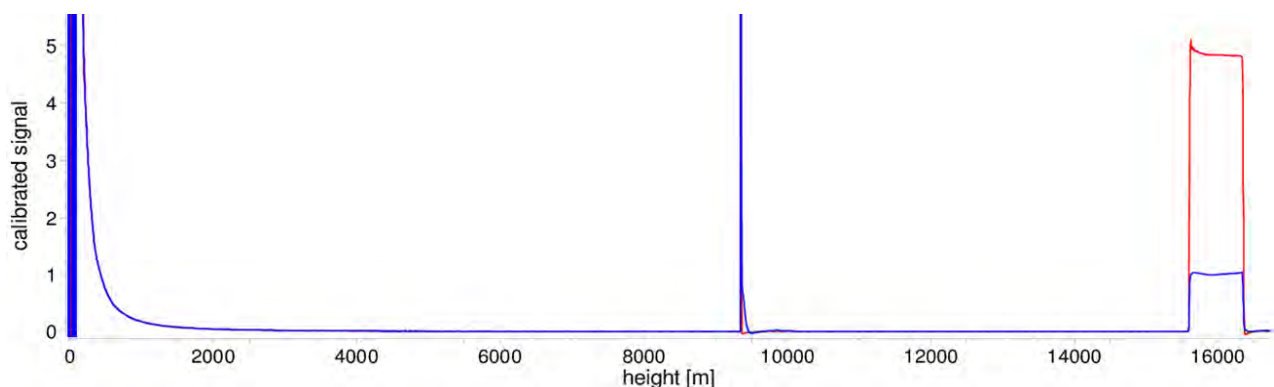

Figure 27 Normalized backscatter signals $P(r)$ for reference unit (blue) and a test unit (red). A horizontal path is used with a hard target in 9.4 km distance for this method. At 16 km distance the reference light pulse is visible.

The following formula is used to obtain the normalized backscatter signal:

$$P(r) = \frac{P_{raw}(r) - b}{c_s \cdot O(r)} \cdot \frac{1}{p_{calc}}$$

Here, P_{raw} corresponds to the raw backscatter signal, b to the baseline and $O(r)$ is the overlap function. p_{calc} and c_s are the normalization and calibration factor, respectively. The normalized backscatter signal $P(r)$ is multiplied with r^2 and stored in the variable `beta_raw` in the NetCDF files.

A further processing step is performed to determine cloud heights and aerosol layers. To compensate for the reducing signal-to-noise ratio at higher altitudes, the signal is averaged with a height-dependent averaging time as shown in Figure 26. At different altitudes, the time averaging varies from 15 seconds below 3 km to 300 seconds above 6 km.

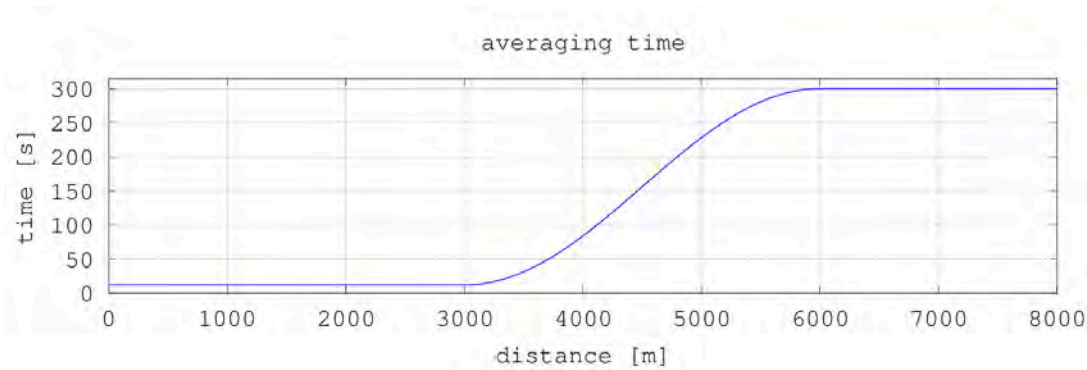

Figure 28 Example of time averaging for determining cloud heights.

9.3 Cloud ceilings / cloud base heights

After successful preprocessing, the averaged backscatter profile is used to identify cloud echoes, rain, fog and aerosol layers and to distinguish between these events.

Figure 27 shows a day intensity plot where all significant backscatter signals are color coded in black.

The SCA algorithm now identifies precipitation events and aerosol structures and then calculates the cloud heights and penetration depths.

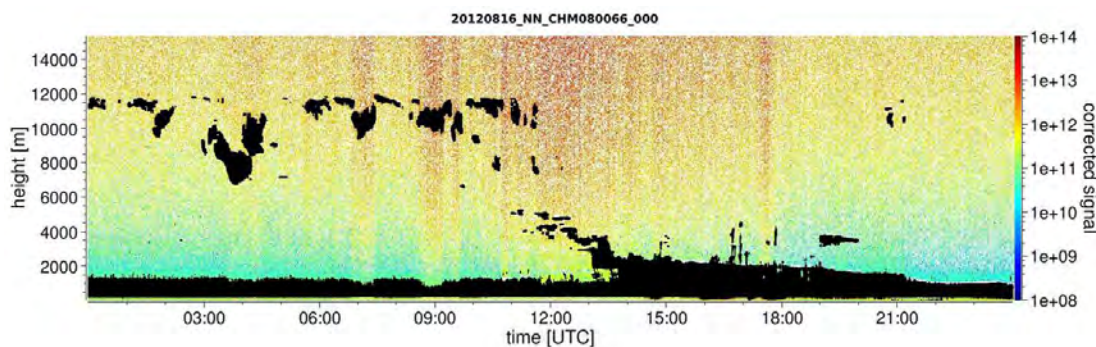

Figure 29 Cloud detection algorithm.

9.4 Cloud penetration depths

Cloud penetration depth is determined by detecting a cloud bottom and then an upper cloud height using the signal intensity level that was determined for the cloud base. Subtracting these values results in the cloud penetration depth.

A threshold and gradient method is used to check the region of the identified values, in order to determine penetration depth uncertainty. Figure 28 shows how the cloud parameter evaluation process is performed.

It should be noted that the above-mentioned upper cloud height is generally not the highest point of the cloud. The penetration depth and the cloud top are similar only when the ceilometer detects another cloud or aerosol layer above it. In most cases, the laser light in the cloud is scattered and highly attenuated and the cloud cover can no longer be identified above the cloud.

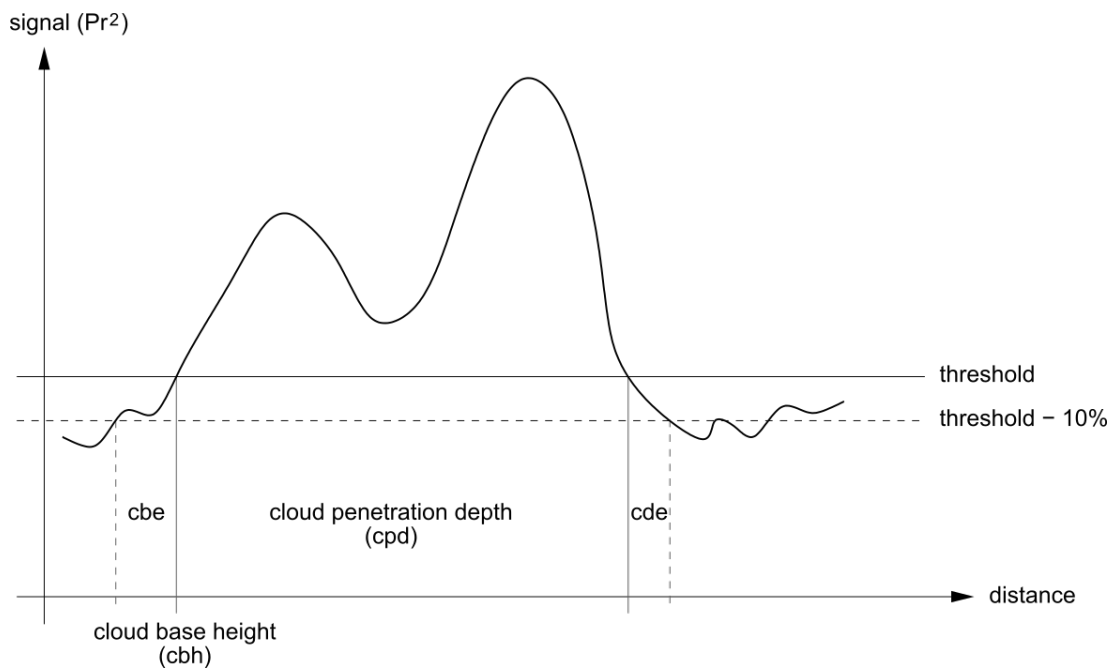

Figure 30 Evaluation process for different cloud parameters.

9.5 Parameters for data evaluation

A set of parameters control the data evaluation routine. System dependent data are stored on the laser optical module (LOM). Data accessible to users are listed in Table 4 and Table 5.

If the instrument is tilted to the zenith and the zenith angle is entered correctly, the cloud distance and other ranges are corrected by this angle.

9.6 Determination of the maximum detection range (MXD)

The maximum detection range corresponds to the maximum distance from which significant signals are still being measured. It results from the signal / noise ratio (S/N) as a function of the distance. At altitudes outside the boundary layer, only clouds or denser aerosol layers generate significant signals. The maximum detection range is calculated independently of the cloud detection algorithm and can be used to check the result, e. g. if the ceilometer can detect neither a cloud layer nor a vertical optical range. Here, the MXD can be used to check whether the result "Clear sky" is correct.

9.7 Vertical optical visibility (VOR)

The method for determining the vertical visibility (VOR: Vertical Optical Range) is described in ISO standard 28902-1:2012. The step by step approach on how the VOR is determined by the device is described below:

First, all sections in the backscatter signal (section 9.2) with a signal-to-noise ratio > 5 are identified. For these relevant intervals, the Klett inversion method is used to process the extinction $\alpha(r)$.

The vertical optical visibility is the distance, where the integral of the extinction is equal to 3.

$$\int_0^{VOR} \alpha(r) dr = 3$$

The range for calculating VOR is limited to an altitude of 3 km. The data output depends on the selected data telegram. In the standard telegrams 1 - 3, the vertical visibility is always transmitted, while in the user telegrams 8 and 9, which correspond to the CT25k data telegram, VOR or the lower cloud limit is transmitted.

9.8 Precipitation and fog

Fog and various types of precipitation are detected by multiple scattering. Typically, only single scattering processes are considered as the signal source. Fog and high particle density correspondingly generate a stronger signal than usual close to the device. An integral over the signal in certain ranges is used to evaluate fog and precipitation.

9.9 Aerosol and mixing layer height

Aerosols that are detected near the ground spread in the lower air layer, where the upper limit can be defined as a planetary boundary layer (onshore) and maritime boundary layer (offshore). The lowest aerosol layer that can be identified within the boundary layer can be interpreted as mixing layer height (MXL). The MXL like all aerosol layer structures in the boundary layer depends on atmospheric conditions and on sunny days mostly on time of day.

Aerosol layer heights can be identified by analyzing gradient signatures in the backscatter signal. The quality of the detected aerosol layers depends very much on the local conditions and time. Table 21 shows an index describing the quality of the identified aerosol layers in terms of high accuracy and low uncertainty.

Q-Index	Description
/ (telegram) -1 (NetCDF)	There is insufficient raw data for a calculation
- (telegram) -2 /NetCDF)	Hardware error or system is not ready to measure
(telegram) -3 (NetCDF)	Algorithm cannot detect values
0	No particle layer detected (Index was not calculated in older firmware versions)
1	Particle layer detected with high accuracy (< 50 m)
9	Particle layer detected, but with low accuracy

Table 22 Q-Index description of aerosol layer height.

9.10 Cloud cover (BCC / TCC)

The cloud coverage is determined statistically from the behavior of the lower cloud bases over time. Here, a distinction is made between the coverage of the lowest cloud layer (BCC: base cloud cover) and the total of all cloud layers (TCC: total cloud cover). The values for these parameters are also stored in the NetCDF files.

The time interval considered is height-dependent (Figure 29). The frequency of the occurring cloud layers is determined for each height interval. This histogram is smoothed with a height-dependent weighting function. Within this smoothed frequency distribution, the peaks are separated. All cloud bases within a peak are bundled into a cloud layer.

Sections that contain cloud bases are counted against the total number of cone sections. The cloud cover values are expressed as a percentage from this comparison. The final degree of coverage is reported in eighths. Table 22 lists the WMO code 2700 for the cloud cover index.

Eighth	Description
- (telegram) -2 (NetCDF)	System hardware error or system not yet ready for operation
/ (telegram) -1 (NetCDF) -3 (NetCDF)	Cloud bases could not be determined due to fog or other non-meteorological reasons, or no observation was made
0	Clear sky
1	1 okta: 1/10 – 2/10
2	2 okta: 2/10 – 3/10
3	3 okta: 4/10
4	4 okta: 5/10
5	5 okta: 6/10
6	6 okta: 7/10 – 8/10
7	7 okta or more, but <10/10
8	8 okta: 10/10
9	sky obscured by fog or other meteorological phenomena

Table 23 Degree of coverage, WMO code 2700 and definitions in 10th.

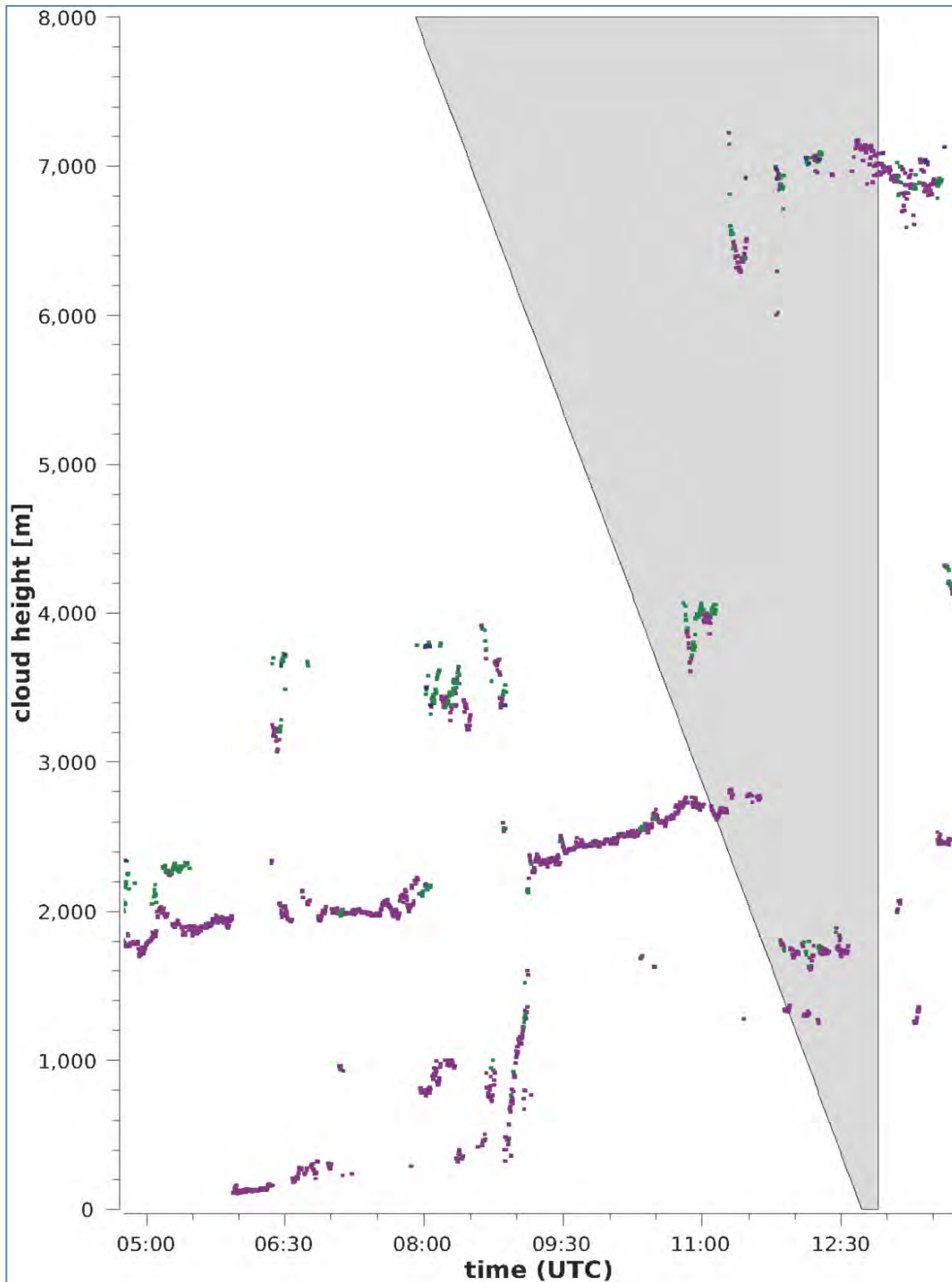

Figure 31 Degree of coverage algorithm.

Note: The selected time interval for calculating the cloud cover depends on the area in which a truncated cone function is used for the calculation.

9.11 Sky Condition Index (SCI)

To better understand certain events, the Sky Condition Index is written to the extended data telegram and NetCDF files. In older CHM systems, the variable was treated as a precipitation index.

Table 23 shows how the index is defined.

Value	Description
-- -2 (NetCDF)	System hardware error or system not yet ready for operation (-2 in NetCDF)
00	Neither fog nor precipitation detected
01	Rain
02	Fog
03	Snow or freezing rain
04	Reduced window transmission, drops on the windows
// (telegram) -1 (NetCDF) -3 (NetCDF)	No observation is made in NetCDF, the numerical values -1, -3 are used in the telegram instead of //

Table 24 Sky Condition Index (SCI).

10 Cleaning, Maintenance and Service Instructions

⚠ CAUTION	
	<p>After switching on the power supply, the CHM 15k emits Class 1M invisible laser radiation through the opening at the top of the sensor. When viewed with optical instruments, Class 1M radiation can lead to serious eye injuries.</p> <ul style="list-style-type: none"> ⇒ Never view the laser beam with optical instruments, especially binoculars ⇒ Avoid looking directly into the laser beam

In normal operation, the correct operation of the device can be checked with two LEDs (see Figure 30). A red LED in the lower right corner of the window panels is an indicator of device failure. The light turns on in case of a hardware or software fault identified by the main controller. Detailed information about the transmitted status are explained in section 8.5 "Status code". The status code is displayed in the web interface status code (see Figure 18) and output in the RS485 data telegrams.

A green LED in the lower left corner of the windows indicates the mains voltage is switched on. When the device is turned on, this LED must be lit. If this is not the case, this indicates an unconnected cable, a switched-off circuit breaker or defective fuses.

10.1 Cleaning

The cover windows of the CHM 15k internal housing are tested for an impact energy of 1 Joule (IEC/EN 61010-1: IK06).

⚠ WARNING	
	<p>Operating the sensor with a broken cover window may result in electric shock, which can cause serious or fatal injury. The shards of the glass can lead to cutting injuries.</p> <ul style="list-style-type: none"> ⇒ Disconnect the ceilometer via the external mains disconnect switch immediately when discovering that a cover window is damaged and secure against reconnection. ⇒ Use protection gloves when handling the broken glass. ⇒ Return the sensor to OTT HydroMet Fellbach GmbH for repair.

NOTICE	
<p>The device may be damaged when maintained insufficiently / inappropriately.</p> <ul style="list-style-type: none"> ⇒ The CHM 15k requires regular cleaning to maintain performance status. ⇒ The CHM 15k requires regular maintenance. This must be performed by service personnel of OTT HydroMet Fellbach GmbH or specially trained technicians only. ⇒ For detailed maintenance instructions, please consult the service manual. 	

Interval	Cleaning	Comment / remedy
Quarterly ¹	Clean the windows (Figure 30) first of all with plenty of water. Carefully spread some soap on the windows with your hands and rinse with water. Finally, rinse with distilled water.	Dishwashing liquid, water, hands Do not use microfiber cloths to clean the windows!
As required	Remove deposits in the space below the housing cover	Neutral cleaning agents; microfiber cloths
As required	Remove fouling in front of the entrance grilles of the fans (rear side)	Keep fan intake area clear, see Figure 31
As required	Remove snow ²	Keep fan intake area clear, see Figure 31

Table 25 Cleaning intervals / measures

¹ with an average dust load of 25 – 35 µg/m³ in the air.

² if snow gets into the air intake of the fans.



Figure 32 Windows to be cleaned.

The red "Error LED" is in the lower right corner of the receiving window.

1: Laser output on the left side, with green indicator light in the lower left corner

2: Receiver output on the right side, with red LED

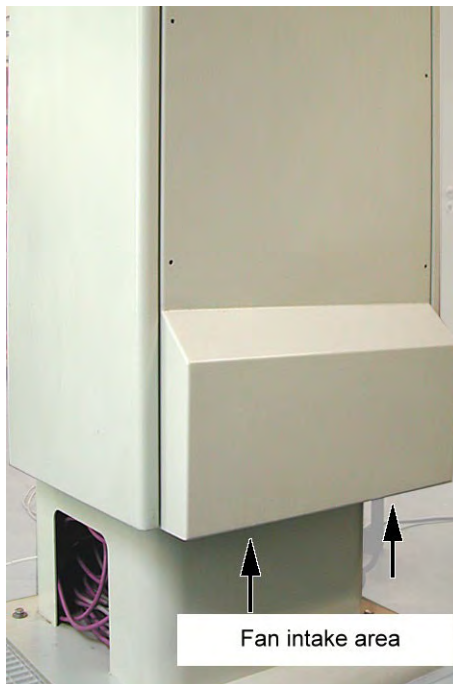

Figure 33 Fan.

The area below the fans must be kept free of snow and debris.

10.2 Maintenance intervals and measures

⚠ WARNING	
	<p>Live parts may be accessible inside the inner sensor housing if a fault occurs. Touching live parts may result in electric shock, which can cause serious or fatal injury.</p> <ul style="list-style-type: none"> ⇒ Do not open the inner sensor housing door. Maintenance work may only be carried out by trained service personnel. All maintenance work requires a technical qualification in electrical safety. ⇒ Switch off the external circuit breaker before carrying out any maintenance and repair work and secure against reconnection.

Table 25 lists the recommended preventive maintenance measures and the interval for regular checks. The inner sensor housing door must be opened to carry out the maintenance measure and the work therefore must be carried out by the service staff of OTT HydroMet Fellbach GmbH or by the customer's authorized and trained personnel.

Further detailed information beyond the scope of this manual (maintenance, replacement, details of units) can be found in the service manual. This is only available to employees of OTT HydroMet Fellbach GmbH or specially trained personnel who possess a written certificate of competence (valid certificate) for the corresponding maintenance and service work.

If you have any questions or a procedure mentioned in this operating manual does not help to remedy an existing problem, we recommend contacting the service technician on site or OTT HydroMet Fellbach GmbH.

Interval	Preventive maintenance measures	Comment
Regular checks	Check the dehumidifier bag CONTAINER DRI II (desiccant) for integrity and replace if necessary	By service staff only
At least once a year	Change the dehumidifier bag CONTAINER DRI II	By service staff only
Approx. every 3 years	Checking the function of the battery pack (only for devices with UPS option)	By service staff only
3 to 5 years	Maintenance of laser optical module (LOM), if signs of laser wear → falling repetition rate, replace SD card	By service staff only
Approx. every 5 years	As a preventive measure: Replace the rubber seal of the inner door (in case of material fatigue)	By service staff only
Approx. every 5 years	As a preventive measure: Replace the lightning conductor (also after lightning strike)	By service staff only
Approx. every 8 years	As a preventive measure: Replace the electronic mainboard	By service staff only

Table 26 Preventive maintenance intervals and measures.

11 Appendix

11.1 CHM 15k device hardware version

Revision	Implementation date	Amendments	Comment
REV 01	01.05.2014	Lufft hardware status 1	First version of Lufft hardware revision
REV 02	01.09.2014	Update CHM Mainboard, new: 41.61225	old 61125 New: 61225
REV 03	01.06.2015	DSL cable new: RS485 cable new 2x2x0.34 LaserController upgrade VDSL modem R4	TWINAX- Lapp#:2170050 Unitronic (DIN color scheme) R1 release MEG250AE
REV 04	1.7.2015	Processor board new, due to obsolete parts	8350.MCP (old 551, new 552)
REV 05	29.7.2015	CHM Mainboard new due to obsolete parts on base board	8350.MCU
REV 06	1.6.2019	EMC and safety related improvements	
REV 07	11.05.2020	Control of fan transformer	
REV 08	23.06.2021	EMV-Verbesserungen	
REV09	04.03.2021	New UPS battery option implemented	

Table 27 Hardware revisions ("000" means value has not been set).

11.2 CHM 15k software version

This manual corresponds to firmware version 1.050 of September 2020 for the CHM 15k ceilometer.

OS / FPGA release	Description	Released
OS 12.12.1 FPGA 2.13	CPU 550: bad block handling implemented Reset ADC temperature sensor	Dec 2012
OS 15.06.1 FPGA 2.13	Original release for CPU release 552	Jun 2015
OS: 15.12.1 FPGA 2.13	Ethernet driver: solves communication issue in direct connection, Laptop – CHM15k Host name is set correctly (device name). Host name is used by AFD „%h“ and submitted to a DHCP-server. In the web interface the IP and the host name can be entered, e.g. CHM160122.lufft.de	Dec 2015
OS 16.05.1 FPGA 2.13	Web-update release of 15.06.1 (same content as 15.12.1)	May 2016
OS 17.05.01 FPGA 2.13	Boot problem with some SD cards fixed	May 2017
OS 18.10.01 FPGA 2.13	Only relevant for production. (Device-dependent use of the EEPROM (e. g. laser life time for CHM8k))	Oct 2018

Table 28 Operating system / FPGA releases

Firmware version	Description	Released
0.723	<ol style="list-style-type: none"> 1. NetCDF bugfix to avoid problems in ctrl process 2. support for new processor board (2015) 3. last Jenoptik release 	Mar 2014
0.730	<ol style="list-style-type: none"> 1. updated cloud algorithm during precipitation events 2. telegram over Ethernet support, now using port 11000 3. aerosol layer detection less sensitive in lower range to avoid artefacts 4. range parameter in webinterface and command interface implemented (RAR, RAS, RAE, RHD) 5. cloud detection is using new flexible range resolution to enable precise post processing 6. Range2DIM in RangeHRDim renamed and max. set to 600 data points 7. serial numbers of various components in EEPROM (opticconfig) added 8. new serial number of mainboard (2015 edition) 	Dec 2014
0.732	<ol style="list-style-type: none"> 1. small adjustments to the cloud algorithm (lower false alarm rate below 100m; signal smoothing changes) 2. first averaging starts at 3 km instead of 2.2 km, + better corresponds to met service requirements 3. DeviceName is preserved at reset settings to factory defaults. 4. Apply settings to factory defaults removed in web-interface (will be redesigned and reintegrated in future) 	May 2015
0.733	<ol style="list-style-type: none"> 1. mainboard revision and processor board revision shown on web interface 2. status code bit 12 (laser controller temperature) combined with bit 13 (laser interlock) as new bit 13 3. test firmware update for compatibility with processor board (error on status code bit 12) 4. decrease valid Laser optical unit temperature from 62°C to 55°C 5. tolerance for APD temperature warning (status code bit 26) increased, now 24°C < x < 28°C 	Jul 2015
0.735	<ol style="list-style-type: none"> 1. Settable altitude range enlarged to [-999m, 9999m], negative values accepted now) 2. Settable range for RangeStart and RangeEnd changed (RangeStart upper limit from 3000 to 1000; RangeEnd lower limit from 8000 to 5500) 3. show corrected laser life time (with LaserInstallTime) on web interface and chmsettings.txt (same as in NetCDF file) 4. new telegrams predefined: #4 (correspond to #2) and #5 (correspond to #1) with the difference that the fan and heating activities are shown at the end of the telegram and the altitude has no positive sign to allow a larger altitude range 	Sep 2015

Firmware version	Description	Released
0.743	<ol style="list-style-type: none"> 1. Aerosol Layer Height (ALH) algorithm was further improved (for ALH values at low SNR) 2. A table with current measurements (cbh, cpd, alh, tcc) are displayed in the viewer tab of the web interface (display is limited to. 5 layers). 3. Used overlap file name and its creation date is displayed in Web Interface as well as saved in the NetCDF file 4. Vaisala CT25K telegram messages No. 1 and 6 are included in user telegrams 8 and 9 5. SD card operation adapted, CHM works without a present SD card 6. New setting DhcpMode & DnsServer available, DHCP mode can be deactivated 7. HTTP port can be set 8. LAN port and Telegram mode for the telegram query via LAN can be set. 	Jul 2016
0.747	<p>Please Note: ChmDataViewer version 1.7 required!</p> <ol style="list-style-type: none"> 1. Current CloudDetectionMode is displayed in the NetCDF attribute 'software_version' on last position (e.g. software_version = "17.05.1 2.13 0.747 1" for Mode 1) 2. Cloud detection variant "higher low clouds" introduced, useable with new settings CloudDetectionMode = 1 (RS485 short: CDM). Restart need after changing the CloudDetectionMode value. 3. Correction for handling time slots after setting the time 4. Display no ALHs above clouds and undershoots and during precipitation 5. Handling Location with umlauts 6. Telegram No. 2 can be used with up to 9 layers 7. Manual: Version R09 integrated 	May 2017
0.754	<ol style="list-style-type: none"> 1. Log Error "APD temperature not in range" (bit 26) only used if PeltierMode is 1 2. Lifetime of APD temperature read errors reduced 3. Changed service password. (Superuser password not changed.) 4. Synchronization of internal file system after important write operations. 5. The fan will not be switched on if the external temperature is not valid. Heat-related ventilation will only be performed if the indoor temperature is valid. 6. Invalid module temperature results in error in status bit 10. 7. Disable AlhFilters in Test-Mode. (relevant for CH-Simulator) 8. Correction: Location parameter can be set to default (NN). 	May 2018

Firmware version	Description	Released
1.000	CHM8k & CHM15k firmware merged based on version 0.753 and 0.754 1. Universal RS485 address 99 introduced, which always works independent of the set RS485Number. 2. Escalating Status code introduced, which will be output in telegram 1 and 5. 3. Output of Status information after device restart (depending on cause of restart) in telegram, Web and NetCDF. 4. Seven additional comment memories for customer availability (32 bytes each) introduced. Comment and Comment1-7 are transmitted at the end of telegram 4. Telegram 4 now has a variable length. The comments take up only as much space as they are long. Comment1-7 (CM1-CM7) can be set via RS485. 5. Determine visibility only on data from the current logging interval. 6. Start time averaging for the cloud detection algorithm above 3050m. 7. Mime type for download of different settings files (chm*, afd*, telegram) fixed. 8. Fix in Cloud Detection (to version 0.727): Dimension Check	Sep 2018
1.010	1. Improvement of the handling of the APD temperature read error 2. Compensate overflow of LaserLifeTime from laser module in firmware	Nov 2018
1.020	1. New: Automatic sending of telegrams via LAN to several clients available in mode 1, LanTransferMode (LTM) (0..polling, 1..auto) 2. Rename old parameter LANTelegramMode in LanTelegramNumber (LTN) to avoid confusion. 3. New: SystemStatusMode (SSM) switch (0 = normal, 1 = escalating status codes in telegrams), (default values are: 0 for CHM 15k, 1 for CHM8k) 4. Additional information (MAC address, CPU serial number, overlap info, motherboard and CPU version) are written into chmsettings.txt configuration file when downloaded. 5. 'Process Warning'-tab renamed in 'Process Status' 6. New: NTP-Status shown in process status tab, when ntpmode=1 and server available, new RS485 command NTP-Status (NST) available. 7. Bug fix: No data processing interference during download of numerous NetCDF files via web interface. 8. Web interface: New Lufft Logo, CHM serial number and Favicon in browser tab 9. Scaling in web viewer corrected 10. Min value auf RangeDimHR set to 10. 11. Hardware revision number shown in web-interface, value is "000" for existing units.	Sep 2019
1.030 1.040	1. Remove NetCDF files at the end of a month only if zip file was created successfully 2. Bugfix (NetCDF creation)	Nov. 2019 Jan. 2020

Firmware version	Description	Released
1.050 1.060	<ol style="list-style-type: none"> Further telegrams (6 and 7) predefined, see section 8.3.6 Extended outputs in the device tab of the web interface and reduction of the update time interval WIGOS Station Identifier introduced. Status code revised (NTP status introduced), see section 8.5 New NetCDF format (beta_att) introduced as well as parameter NetcdfMode for format switching, see section 8.4, Table 14 and Table 15 Note: For correct display in the CHM Data Viewer software a version 2.5 or higher is required. Revision of the quality index pbs of aerosol layer detection Correction of the calculation of optical state (state_optics) and thus the occurrence of the window contamination warning Firmware adapted for compatibility with new CHM cloud simulator Feedback behaviour for firmware updates via web interface revised Bug fixes 	Sep. 2020 Oct. 2020
1.070	<ol style="list-style-type: none"> Re-sorting of the status code. "Note: NTP problem" set to bit 12, see section 8.5. Changes in telegrams 1 to 5: output of cloud height offset instead of altitude, see section 8.3.3ff Changes in telegrams 1 to 3: output cloud height offset for non-negative values without "+". This allows to output a maximum value of 9999 instead of only +999 (meters or feet, depending on the setting). Limits for outdoor temperature warning set to -40°C to 50°C. 	Nov. 2020
1.080	<ol style="list-style-type: none"> Bugfix: Number of digits of cloud height offset in telegram 1 and 5 fixed to 4 again. 	Dec. 2020
1.090	<ol style="list-style-type: none"> Telegram change as the status was undefined before: As overflow value the character '?' will be used. Except when a valid overflow value is defined in telegramformat.xml, details also in the document "XML-CHM-telegram-format.pdf". Preset are: <ul style="list-style-type: none"> Telegram 1 and 5: Overflow "9999" for penetration depth (CPD) Telegram 2 and 4: Overflow "9999" for standard deviation of the penetration depth (CDE) Upload of the telegram format xml file now possible as "SuperUser" via web front end. Character length for parameter (Location, Institution,...) will be cut to max field length, see Table 5 List of configurable parameters, 	March 2021
1.100	Correction of the check sum of "CL31- telegrams"	May 2021
1.110	<ol style="list-style-type: none"> Shutdown time of the firmware reduced to 4s Downgrade option of firmware removed NTP failure state (Bit 12) is no longer displayed on the red housing (failure) LED Parameter "rangeEnd" works for selected ranges <6000m CHMTestMode can be switched off via web frontend even if it was started from RS485 Correction aerosol layer detection when using the CH-simulator (bug since version 1.050) 	Mar 2022

Table 29 Firmware revisions

a passion for precision · passion pour la précision · pasión por la precisión · passione per la precisione · a pa



OTT HydroMet Fellbach GmbH
Gutenbergstraße 20
70736 Fellbach

Phone: +49 711 518 22 – 0
met-info@otthydromet.com
www.lufft.com